det al d oral
det al ad oral
odot ob gá y oral
det al et oral
odot oät rà e orab

nopa[®] instruments





Dies ist unser Katalog, er bleibt unser ausschließliches Eigentum. Es gelten unsere allgemeinen Lieferbedingungen. Sie finden diese auf unserer Internetseite: www.nopa-instruments.com.

This is our Catalogue. It remains our exclusive property. Please find our "General Terms of Sale" on our corporate website: www.nopa-instruments.com.

Esto es nuestro catálogo y queda nuestra propiedad. Nuestros condiciones generales de venta se encuentran en nuestra página web: www.nopa-instruments.com.

Voilà notre catalogue et il demeure notre propriété. Veuillez consulter nos conditions générales de vente sur notre page Internet : www.nopa-instruments.com.

Questo è nostro catalogo e rimane nostra proprietà. Trovano applicazione le nostre condizioni generali di fornitura, che sono disponibili sul nostro sito: www.nopa-instruments.com.

Modelländerungen vorbehalten. Nachdruck, auch auszugsweise, verboten.
Change of design and pattern reserved. Re-printing, even in extracts, not permitted.
Nos reservamos el derecho de modificaciones sin aviso previo. Reimpresión, también parcialmente, esta prohibido.
Tous droits réservés aux changements de modèle. Réimprimer, également partiellement, est interdit.
Noi riserviamo il diritto di effettuare delle modificazioni. Ristampa di divieto anche parziale.



confidence in

nopa[®] instruments

more than

30
YEARS

thank you for choosing

nopa[®] instruments

...you obviously have good taste

Bitte fordern Sie unsere
entsprechenden Kataloge an.

Please request for our
appropriate catalogues.

Por favor pidan por nuestros
catálogos apropiados.

Veillez demander nos
catalogues appropriés.

Chieda prego i nostri
cataloghi adatti.

>> Unser Lieferprogramm

Allgemeinchirurgie und Gynäkologie
Plastische Chirurgie und HNO
Cardiovascular
Neurochirurgie
Ophthalmologie
Endoskopie
Behältnisse zur Instrumentensterilisation
Dental und Oral

>> Our product range

General Surgery and Gynecology
Plastic Surgery and ENT
Cardiovascular
Neurosurgery
Ophthalmology
Endoscopy
Sterilizing Containers
Dental and Oral

**>> Nuestro gama
de productos**

Cirugía generales y Ginecología
Cirugía plástica y ORL
Cardiovasculares
Neurocirugía
Oftalmología
Endoscópico
Cajas para esterilización
Odontología y Oral

>> Notre gamme

Chirurgie générale et Gynecologie
Chirurgie plastique et ORL
Cardiovasculaires
Neurochirurgie
Ophtalmologie
Endoscopie
Des boîtes à instruments et pour la stérilisation
Dental et Oral

**>> Nostro programma
di produzione**

Chirurgia generale e Ginecologia
Chirurgia plastica ed ORL
Cardiovascolari
Neurochirurgia
Oftalmologia
Endoscopia
Astucci per la sterilizzazione
Odontoiatria e Orale

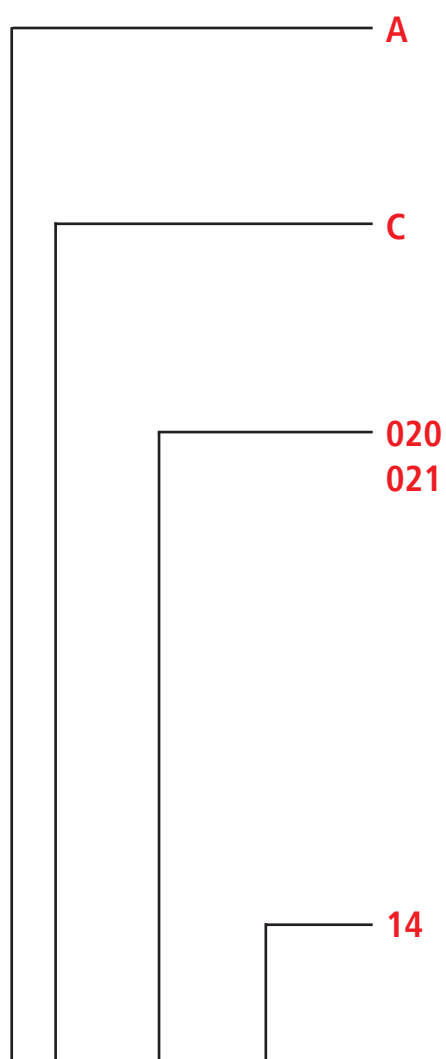

Artikelcode **AC 020/14**

Allgemeines Instrumentarium

General Instruments
Instrumental Général
Instruments Générales
Strumenti generali

Scheren

Scissors
Tijeras
Ciseaux
Forbici

Fortlaufende Nummern

Gerade Ziffer = gerades Instrument
Ungerade Ziffer = gebogenes Instrument

Continuous number

Even number = straight instrument
Odd number = curved instrument

Número de orden

números pares = instrumento derecho
números impares = instrumento curvado

Numéros d'ordre

numéro pair = instrument droit
numéro impair = instrument courbe

Numeri progressivamente

numero pari = strumento retto
numero dispari = strumento curvo

Länge oder Figur

Length or Figure
Longitud o figura
Longueur ou figure
Lunghezza o figura

AA/AB	>> Klemmen • Hemostats • Pinzas hemostáticas • Pinces hémostatiques • Pinze emostatiche >> Pinzetten • Forceps • Pinzas • Pinces • Pinze	7–32
AC/AD	>> Scheren • Scissors • Tijeras • Ciseaux • Forbici >> Skalpelle • Scalpels • Bisturíes • Bistouris • Bisturi	33–64
AE	>> Naht • Suture • Sutura • Suture • Sutura	65–84
AF	>> Tupferzangen • Sponge Forceps • Pinzas para pólipos • Pinces à pansements Pinze per polipi	85–88
AK	>> Wundhaken • Retractors • Separadores • Ecarteurs • Divaricatori	89–100
AL/AO	>> Sonden, Trokare, Saugrohre • Probes, Trocars, Suction Tubes Sondas, Trócares, Tubos de aspiración • Sondes, Trocars, canules d'aspiration Sonde, Tre quarti, Cannule per aspirazione	101–110
AR	>> Messinstrumente • Measuring instruments • Instrumentos para medidas Instruments pour mesurer • Strumenti per misurare	111–118
KA	>> Knocheninstrumente • Bone instruments • Instrumentos para hueso Instruments à l'os • Strumenti per osso	119–138
KL	>> Mund/Zunge • Oral Instruments • Boca/Lengua • Bouche/Langue • Bocca/Lingua	139–150
KU	>> Verschiedenes • Various items • Diversos artículos • Articles divers • Articoli diversi	151–160

<p>>> Zahnzangen • Extracting forceps • Forceps de extracción • Daviers • Pinza per estrazione – english pattern –</p> <p style="text-align: right;">161–204</p>	<p>PA</p>
<p>>> Zahnzangen • Extracting forceps • Forceps de extracción • Daviers • Pinza per estrazione – american pattern –</p> <p style="text-align: right;">205–224</p>	<p>PB</p>
<p>>> Wurzelheber • Root elevators • Elevadores para raíces • Elevateurs à racines Elevatori per radici</p> <p style="text-align: right;">225–248</p>	<p>PF</p>
<p>>> Zahnreiniger • Dental scalers • Limpiadores de sarro • Instruments à detarter Levatartari dentali</p> <p>>> Paradontologie • Periodontology • Paradontologia • Paradontologie • Paradontologia</p> <p>>> Sonden • Probes/Explorers • Sondas • Sondes • Sonde</p> <p>>> Exkavatoren • Excavators • Excavadores • Excavateurs • Escavatori</p> <p style="text-align: right;">249–280</p>	<p>PI-PM</p>
<p>>> Schmelzmeißel, Füllungsinstrumente • Enamel chisels, filling instruments Cinceles para esmalte, instrumentos para obturaciones • Ciseaux à email, instruments pour plombages • Tagliasmalto, Otturatori</p> <p style="text-align: right;">281–302</p>	<p>PP/PS</p>
<p>>> Prothetik und Orthodontie • Prothetics and orthodontia • Prothesis y ortodoncia Prothese et orthodontie • Protesi e ortodonzia</p> <p style="text-align: right;">303–332</p>	<p>PT</p>
<p>>> Matrizen • Matrix • Matrices • Matrice • Matrici</p> <p style="text-align: right;">333–338</p>	<p>PU</p>
<p>>> Implantologie • Implantology • Implantologia • Implantologie • Implantologia</p> <p style="text-align: right;">339–346</p>	<p>PV</p>
<p>>> Sterilisationsbehältnisse und Norm-Trays • Sterilizing containers and standard trays Cajas para esterilización y bandejas estándar • Des boîtes à instruments et pour la stérilisation et trays standard • Astucci per la sterilizzazione e bacinelle standard</p> <p style="text-align: right;">347–362</p>	<p>KYE</p>



KLEMMEN
HEMOSTATS
PINZAS HEMOSTATICAS
PINCES HEMOSTATIQUES
PINZE EMOSTATICHE

AA

nopa[®] instruments



Arterienklemmen
 Artery Forceps
 Pinzas hemostáticas
 Pincas hémostatiques
 Pinze emostatiche

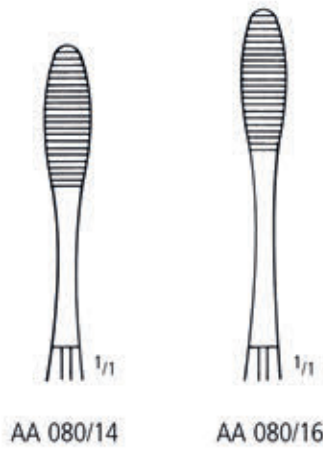

PEAN
 14,0 cm/5 1/2" AA 080/14
 16,0 cm/6 1/4" AA 080/16

HARTMANN
 AA 114/10
 10,0 cm/4"



HARTMANN
 AA 115/10
 10,0 cm/4"

CARREL
 AA 116/08
 8,5 cm/3 1/2"

TERRIER 1:2
 AA 118/08
 8,5 cm/3 1/2"

Arterienklemmen
Artery Forceps
Pinzas hemostáticas
Pinces hémostatiques
Pinze emostatiche

AA
AB
AC
AD
AE
AF
AK
AL
AO
AR
KA
KL
KU
PA
PB
PF
PI
PK
PL
PM
PP
PS
PT
PU
PV
KYE

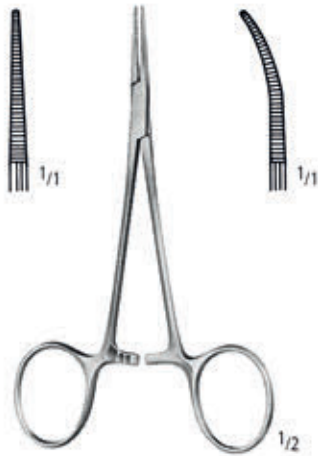

MICRO-MOSQUITO

AA 130/10 AA 131/10
AA 130/12 AA 131/12

10,0 cm/4"
12,0 cm/4³/₄"

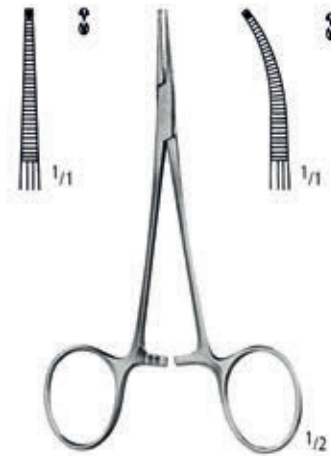

MICRO-MOSQUITO 1:2

AA 132/10 AA 133/10
AA 132/12 AA 133/12

WILLIAM STEWART HALSTED

was professor of surgery in the Johns Hopkins University. In 1890 he had bronze casts made of his own hands. On these casts the first surgical rubber gloves were moulded.



HALSTED-MOSQUITO

AA 150/12 AA 151/12
AA 150/14 AA 151/14

12,5 cm/5"
14,0 cm/5¹/₂"

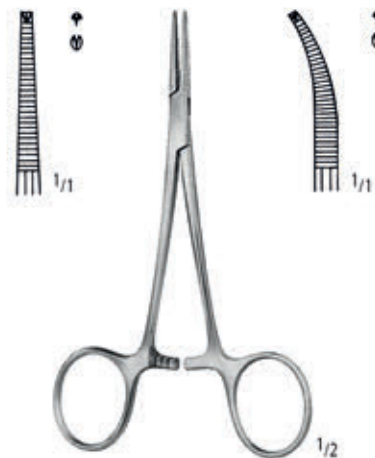

HALSTED-MOSQUITO 1:2

AA 152/12 AA 153/12
AA 152/14 AA 153/14

AA KLEMMEN HEMOSTATS PINZAS HEMOSTATICAS PINCES HEMOSTATIQUES PINZE EMOSTATICHE

Arterienklemmen
 Artery Forceps
 Pinzas hemostáticas
 Pincas hémostatiques
 Pinze emostatiche



AA 156/18
 18,0 cm/7"

AA 156/21
 21,0 cm/8¹/₄"

HALSTED



AA 157/18
 18,0 cm/7"

AA 157/21
 21,0 cm/8¹/₄"

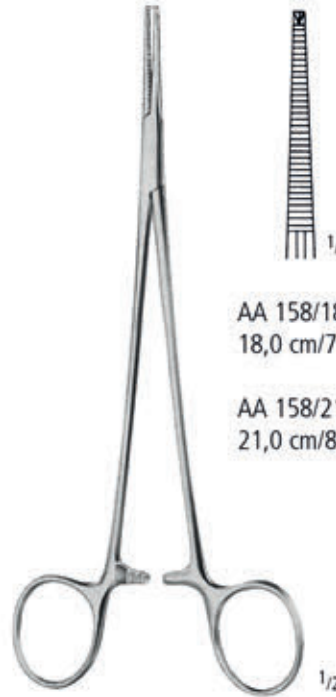

AA 158/18
 18,0 cm/7"

AA 158/21
 21,0 cm/8¹/₄"

HALSTED 1:2



AA 159/18
 18,0 cm/7"

AA 159/21
 21,0 cm/8¹/₄"

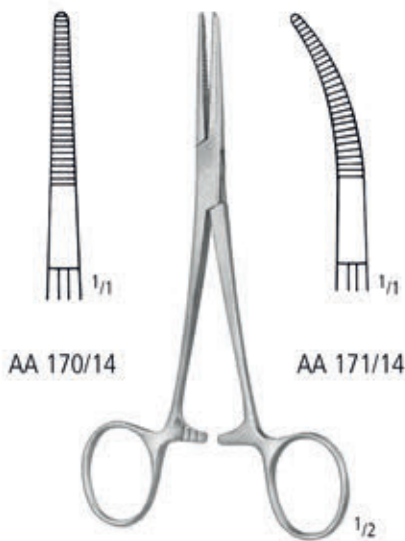

AA 170/14

AA 171/14

KELLY
 14,0 cm/5¹/₂"

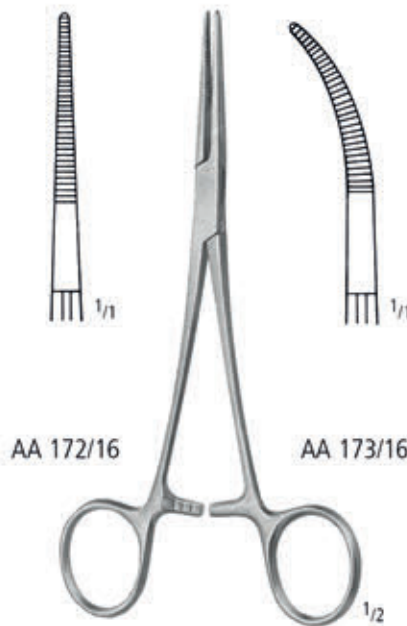

AA 172/16

AA 173/16

KELLY-RANKIN
 16,0 cm/6¹/₄"

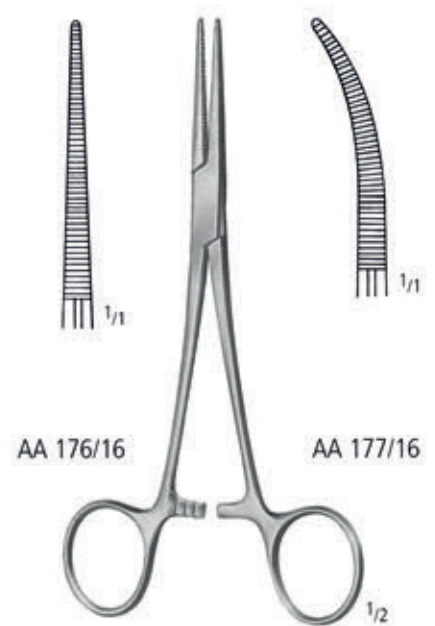

AA 176/16

AA 177/16

COLLER
 AA 176/14 14,0 cm/5¹/₂" AA 177/14
 AA 176/16 16,0 cm/6¹/₄" AA 177/16

Arterienklemmen
 Artery Forceps
 Pinzas hemostáticas
 Pincès hémostatiques
 Pinze emostatiche

AA

AB

AC

AD

AE

AF

AK

AL

AO

AR

KA

KL

KU

PA

PB

PF

PI

PK

PL

PM

PP

PS

PT

PU

PV

KYE

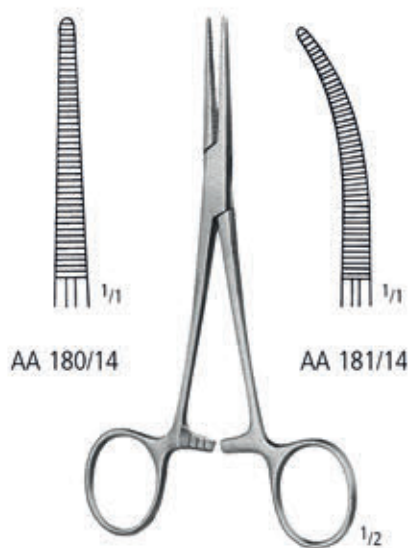

AA 180/14

AA 181/14

CRILE
 14,0 cm/5½"

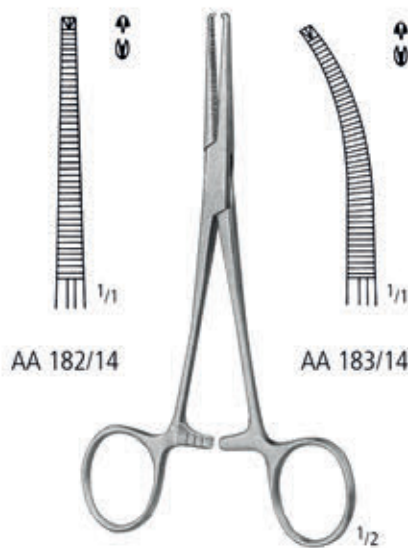

AA 182/14

AA 183/14

CRILE 1:2
 14,0 cm/5½"

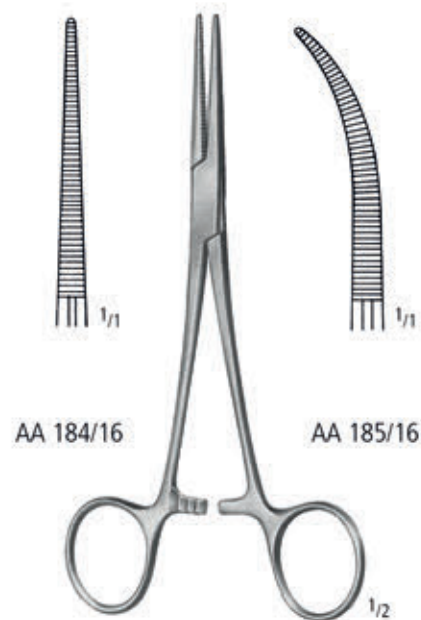

AA 184/16

AA 185/16

CRILE-RANKIN
 16,0 cm/6¼"



ROCHESTER-PEAN



AA 200/14
 14,0 cm/5½"

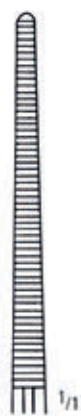

AA 200/16
 16,0 cm/6¼"



AA 201/14
 14,0 cm/5½"



AA 201/16
 16,0 cm/6¼"

Arterienklemmen
 Artery Forceps
 Pinzas hemostáticas
 Pincas hémostatiques
 Pinze emostatiche



OCHSNER-KOCHER 1:2

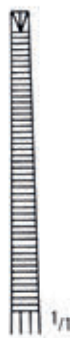

AA 210/14
 14,0 cm/5¹/₂"



AA 210/16
 16,0 cm/6¹/₄"



AA 211/14
 14,0 cm/5¹/₂"



AA 211/16
 16,0 cm/6¹/₄"

Arterienklemmen, Graze Arterienklemmen
 Artery Forceps, Delicate Artery Forceps
 Pinzas hemostáticas, Pinzas hemostáticas delgadas
 Pincés hémostatiques, Pincés hémostatiques graciles
 Pinze emostatiche, Pinze emostatiche delicate

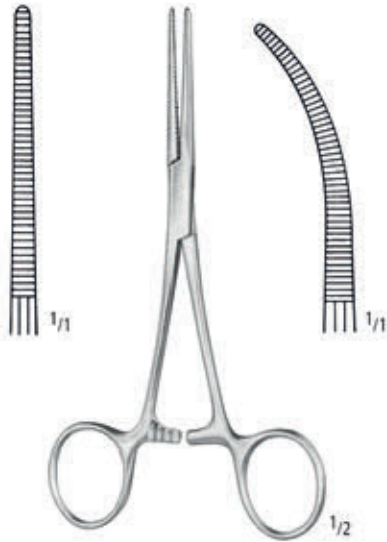

PEAN - DELICATE

AA 214/13	AA 215/13
AA 214/14	AA 215/14
AA 214/16	AA 215/16

13,0 cm/5"
 14,0 cm/5½"
 16,0 cm/6¼"

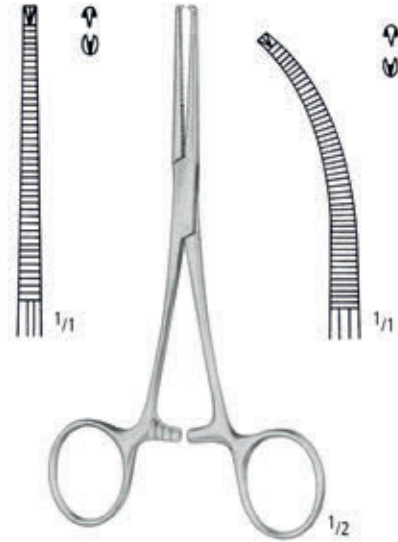

KOCHER 1:2 - DELICATE

AA 216/13	AA 217/13
AA 216/14	AA 217/14
AA 216/16	AA 217/16



BABY-ADSON

AA 235/14
 14,0 cm/5½"



BABY-ADSON

AA 237/18
 18,0 cm/7"

AA
 AB
 AC
 AD
 AE
 AF
 AG
 AH
 AI
 AJ
 AK
 AL
 AM
 AN
 AO
 AP
 AQ
 AR
 AS
 AT
 AU
 AV
 AW
 AX
 AY
 AZ
 BA
 BB
 BC
 BD
 BE
 BF
 BG
 BH
 BI
 BJ
 BK
 BL
 BM
 BN
 BO
 BP
 BQ
 BR
 BS
 BT
 BU
 BV
 BW
 BX
 BY
 BZ
 CA
 CB
 CC
 CD
 CE
 CF
 CG
 CH
 CI
 CJ
 CK
 CL
 CM
 CN
 CO
 CP
 CQ
 CR
 CS
 CT
 CU
 CV
 CW
 CX
 CY
 CZ
 DA
 DB
 DC
 DD
 DE
 DF
 DG
 DH
 DI
 DJ
 DK
 DL
 DM
 DN
 DO
 DP
 DQ
 DR
 DS
 DT
 DU
 DV
 DW
 DX
 DY
 DZ
 EA
 EB
 EC
 ED
 EE
 EF
 EG
 EH
 EI
 EJ
 EK
 EL
 EM
 EN
 EO
 EP
 EQ
 ER
 ES
 ET
 EU
 EV
 EW
 EX
 EY
 EZ
 FA
 FB
 FC
 FD
 FE
 FF
 FG
 FH
 FI
 FJ
 FK
 FL
 FM
 FN
 FO
 FP
 FQ
 FR
 FS
 FT
 FU
 FV
 FW
 FX
 FY
 FZ
 GA
 GB
 GC
 GD
 GE
 GF
 GG
 GH
 GI
 GJ
 GK
 GL
 GM
 GN
 GO
 GP
 GQ
 GR
 GS
 GT
 GU
 GV
 GW
 GX
 GY
 GZ
 HA
 HB
 HC
 HD
 HE
 HF
 HG
 HH
 HI
 HJ
 HK
 HL
 HM
 HN
 HO
 HP
 HQ
 HR
 HS
 HT
 HU
 HV
 HW
 HX
 HY
 HZ
 IA
 IB
 IC
 ID
 IE
 IF
 IG
 IH
 II
 IJ
 IK
 IL
 IM
 IN
 IO
 IP
 IQ
 IR
 IS
 IT
 IU
 IV
 IW
 IX
 IY
 IZ
 JA
 JB
 JC
 JD
 JE
 JF
 JG
 JH
 JI
 JJ
 JK
 JL
 JM
 JN
 JO
 JP
 JQ
 JR
 JS
 JT
 JU
 JV
 JW
 JX
 JY
 JZ
 KA
 KB
 KC
 KD
 KE
 KF
 KG
 KH
 KI
 KJ
 KK
 KL
 KM
 KN
 KO
 KP
 KQ
 KR
 KS
 KT
 KU
 KV
 KW
 KX
 KY
 KZ
 LA
 LB
 LC
 LD
 LE
 LF
 LG
 LH
 LI
 LJ
 LK
 LL
 LM
 LN
 LO
 LP
 LQ
 LR
 LS
 LT
 LU
 LV
 LW
 LX
 LY
 LZ
 MA
 MB
 MC
 MD
 ME
 MF
 MG
 MH
 MI
 MJ
 MK
 ML
 MM
 MN
 MO
 MP
 MQ
 MR
 MS
 MT
 MU
 MV
 MW
 MX
 MY
 MZ
 NA
 NB
 NC
 ND
 NE
 NF
 NG
 NH
 NI
 NJ
 NK
 NL
 NM
 NN
 NO
 NP
 NQ
 NR
 NS
 NT
 NU
 NV
 NW
 NX
 NY
 NZ
 OA
 OB
 OC
 OD
 OE
 OF
 OG
 OH
 OI
 OJ
 OK
 OL
 OM
 ON
 OO
 OP
 OQ
 OR
 OS
 OT
 OU
 OV
 OW
 OX
 OY
 OZ
 PA
 PB
 PC
 PD
 PE
 PF
 PG
 PH
 PI
 PJ
 PK
 PL
 PM
 PN
 PO
 PP
 PQ
 PR
 PS
 PT
 PU
 PV
 PW
 PX
 PY
 PZ
 QA
 QB
 QC
 QD
 QE
 QF
 QG
 QH
 QI
 QJ
 QK
 QL
 QM
 QN
 QO
 QP
 QQ
 QR
 QS
 QT
 QU
 QV
 QW
 QX
 QY
 QZ
 RA
 RB
 RC
 RD
 RE
 RF
 RG
 RH
 RI
 RJ
 RK
 RL
 RM
 RN
 RO
 RP
 RQ
 RR
 RS
 RT
 RU
 RV
 RW
 RX
 RY
 RZ
 SA
 SB
 SC
 SD
 SE
 SF
 SG
 SH
 SI
 SJ
 SK
 SL
 SM
 SN
 SO
 SP
 SQ
 SR
 SS
 ST
 SU
 SV
 SW
 SX
 SY
 SZ
 TA
 TB
 TC
 TD
 TE
 TF
 TG
 TH
 TI
 TJ
 TK
 TL
 TM
 TN
 TO
 TP
 TQ
 TR
 TS
 TT
 TU
 TV
 TW
 TX
 TY
 TZ
 UA
 UB
 UC
 UD
 UE
 UF
 UG
 UH
 UI
 UJ
 UK
 UL
 UM
 UN
 UO
 UP
 UQ
 UR
 US
 UT
 UY
 UZ
 VA
 VB
 VC
 VD
 VE
 VF
 VG
 VH
 VI
 VJ
 VK
 VL
 VM
 VN
 VO
 VP
 VQ
 VR
 VS
 VT
 VU
 VV
 VW
 VX
 VY
 VZ
 WA
 WB
 WC
 WD
 WE
 WF
 WG
 WH
 WI
 WJ
 WK
 WL
 WM
 WN
 WO
 WP
 WQ
 WR
 WS
 WT
 WU
 WV
 WW
 WX
 WY
 WZ
 XA
 XB
 XC
 XD
 XE
 XF
 XG
 XH
 XI
 XJ
 XK
 XL
 XM
 XN
 XO
 XP
 XQ
 XR
 XS
 XT
 XU
 XV
 XW
 XX
 XY
 XZ
 YA
 YB
 YC
 YD
 YE
 YF
 YG
 YH
 YI
 YJ
 YK
 YL
 YM
 YN
 YO
 YP
 YQ
 YR
 YS
 YT
 YU
 YV
 YW
 YX
 YY
 YZ
 ZA
 ZB
 ZC
 ZD
 ZE
 ZF
 ZG
 ZH
 ZI
 ZJ
 ZK
 ZL
 ZM
 ZN
 ZO
 ZP
 ZQ
 ZR
 ZS
 ZT
 ZU
 ZV
 ZW
 ZX
 ZY
 ZZ

Tuchklemmen
Towel Forceps
Pinzas para compresas, Pinzas de campo
Pinces à champs, Pinces à compresses
Pinze per fissare le compresse (Fissatele)



SCHAEDEL
AA 710/09
9,0 cm/3 1/2"



JONES
5,0 cm/2"
9,0 cm/3 1/2" AA 711/05
AA 711/09



ENGL. MODELL
AA 717/09
9,0 cm/3 1/2"



AA 749/11
11,0 cm/4 1/2"

- >> mit Schlauch- oder Kabelhalter
- >> with Clip for Tubing or Cable
- >> con porta-tubo o porta-cable
- >> avec clamp porte-Tube ou
- >> porte-corton d'alimentation
- >> con porta tubo o porta cavo



BACKHAUS
8,0 cm/3 1/4" AA 751/08
11,0 cm/4 1/2" AA 751/11
13,0 cm/5" AA 751/13
15,0 cm/6" AA 751/15

Tuchklemmen
Towel Forceps
Pinzas para compresas, Pinzas de campo
Pincés à champs, Pincés à compreses
Pinze per fissare le compresse (Fissatele)

AA

AB

AC

AD

AE

AF

AK

AL

AO

AR

KA

KL

KU

PA

PB

PF

PI

PK

PL

PM

PP

PS

PT

PU

PV

KYE



BALL & SOCKET

11,0 cm/4³/₈" AA 753/11
13,0 cm/5" AA 753/13



ROEDER

13,0 cm/5" AA 761/13
15,0 cm/6" AA 761/15



LORNA

10,0 cm/4" AA 763/10
13,0 cm/5" AA 763/13



TOHOKU-JAPAN

10,0 cm/4" AA 764/10
13,0 cm/5" AA 764/13



PEERS

AA 765/14
14,5 cm/5³/₄"

- >> für Papiertücher
- >> for paper tissues
- >> para servilletas de papel
- >> pour serviettes en papier
- >> per tessuti di carta

PINZETTEN
FORCEPS
PINZAS
PINCES
PINZE

AB

nopa[®] instruments



PINZETTEN FORCEPS PINZAS PINCES PINZE

Anatomische Pinzetten, Chirurgische Pinzetten
 Dressing Forceps, Tissue Forceps
 Pinzas de disección, Pinzas de disección con dientes
 Pincers à dissection, Pincers à griffes
 Pinze anatomiche per dissezione, Pinze chirurgiche a denti di topo

AA
 AB
 AC
 AD
 AE
 AF
 AK
 AL
 AO
 AR
 KA
 KL
 KU
 PA
 PB
 PF
 PI
 PK
 PL
 PM
 PP
 PS
 PT
 PU
 PV
 KYE



1/2

STANDARD



AB 050/10
 10,5 cm/4¹/₄"



AB 050/11
 11,5 cm/4¹/₂"



AB 050/13
 13,0 cm/5"



AB 050/14
 14,5 cm/5³/₄"



AB 050/16
 16,0 cm/6¹/₄"



AB 050/18
 18,0 cm/7"

10,5 cm/4 ¹ / ₄ "	AB 050/10
11,5 cm/4 ¹ / ₂ "	AB 050/11
13,0 cm/5"	AB 050/13
14,5 cm/5 ³ / ₄ "	AB 050/14
16,0 cm/6 ¹ / ₄ "	AB 050/16
18,0 cm/7"	AB 050/18



1/2

STANDARD 1:2



AB 060/10
 10,5 cm/4¹/₄"



AB 060/11
 11,5 cm/4¹/₂"



AB 060/13
 13,0 cm/5"



AB 060/14
 14,5 cm/5³/₄"



AB 060/16
 16,0 cm/6¹/₄"



AB 060/18
 18,0 cm/7"

10,5 cm/4 ¹ / ₄ "	AB 060/10
11,5 cm/4 ¹ / ₂ "	AB 060/11
13,0 cm/5"	AB 060/13
14,5 cm/5 ³ / ₄ "	AB 060/14
16,0 cm/6 ¹ / ₄ "	AB 060/16
18,0 cm/7"	AB 060/18

AB PINZETTEN FORCEPS PINZAS PINCES PINZE

Anatomische Pinzetten, Chirurgische Pinzetten
 Dressing Forceps, Tissue Forceps
 Pinzas de disección, Pinzas de disección con dientes
 Pincers à dissection, Pincers à griffes
 Pinze anatomiche per dissezione, Pinze chirurgiche a denti di topo



	schmal >> narrow >> estrechas >> étroites >> strette			
10,5 cm/4 ¹ / ₄ "	AB 070/10	AB 071/10	AB 080/10	AB 081/10
11,5 cm/4 ¹ / ₂ "	AB 070/11	AB 071/11	AB 080/11	AB 081/11
13,0 cm/5"	AB 070/13	AB 071/13	AB 080/13	AB 081/13
14,5 cm/5 ³ / ₄ "	AB 070/14	AB 071/14	AB 080/14	AB 081/14
16,0 cm/6 ¹ / ₄ "	AB 070/16	AB 071/16	AB 080/16	AB 081/16
18,0 cm/7"	AB 070/18	AB 071/18	AB 080/18	AB 081/18
20,0 cm/8"	AB 070/20	AB 071/20	AB 080/20	AB 081/20
23,0 cm/9"	AB 070/23		AB 080/23	
25,0 cm/10"	AB 070/25	AB 071/25	AB 080/25	AB 081/25
30,0 cm/12"	AB 070/30	AB 071/30	AB 080/30	AB 081/30

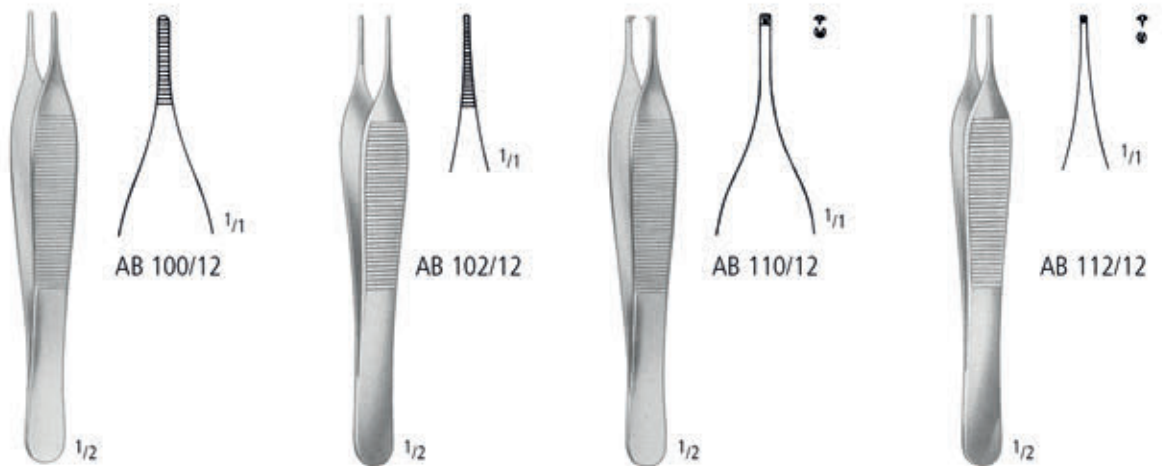

12,0 cm/4 ³ / ₄ "	ADSON	MICRO-ADSON	ADSON 1:2	MICRO-ADSON 1:2
15,0 cm/6"	AB 100/12 AB 100/15	AB 102/12 AB 102/15	AB 110/12 AB 110/15	AB 112/12 AB 112/15

PINZETTEN FORCEPS PINZAS PINCES PINZE

Anatomische Pinzetten, Chirurgische Pinzetten
 Dressing Forceps, Tissue Forceps
 Pinzas de disección, Pinzas de disección con dientes
 Pincers à dissection, Pincers à griffes
 Pinze anatomiche per dissezione, Pinze chirurgiche a denti di topo

AA
 AB
 AC
 AD
 AE
 AF
 AK
 AL
 AO
 AR
 KA
 KL
 KU
 PA
 PB
 PF
 PI
 PK
 PL
 PM
 PP
 PS
 PT
 PU
 PV
 KYE



ADSON
 AB 114/12
 12,0 cm/4³/₄"

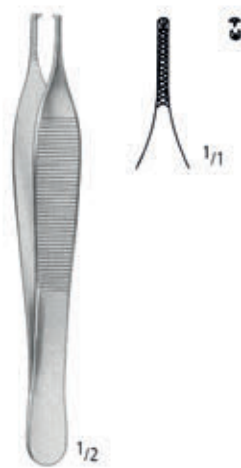

ADSON 1:2
 AB 115/12
 12,0 cm/4³/₄"



ADSON-BROWN
 12,0 cm/4³/₄"



ADSON-BROWN
 AB 117/09
 12,0 cm/4³/₄"



EWALD
 AB 118/01
 12,0 cm/4³/₄"



EWALD 1:2
 AB 118/02
 12,0 cm/4³/₄"



McINDOE
 AB 119/15
 15,0 cm/6"



AB 120/12
 AB 120/15



SEMKEN
 12,5 cm/5"
 15,5 cm/6"
 AB 121/12
 AB 121/15

AB PINZETTEN FORCEPS PINZAS PINCES PINZE

Anatomische Pinzetten, Chirurgische Pinzetten
 Dressing Forceps, Tissue Forceps
 Pinzas de disección, Pinzas de disección con dientes
 Pincers à dissection, Pincers à griffes
 Pinze anatomiche per dissezione, Pinze chirurgiche a denti di topo



AB 130/12



AB 131/12



TAYLOR
 AB 140/17
 17,5 cm/7"



TAYLOR
 AB 141/17
 17,5 cm/7"

SEMKEN 1:2
 AB 130/12 12,5 cm/5" AB 131/12
 AB 130/15 15,5 cm/6" AB 131/15



TAYLOR
 AB 142/17
 17,5 cm/7"



TAYLOR
 AB 143/17
 17,5 cm/7"



TAYLOR 1:2
 AB 150/17
 17,5 cm/7"



TAYLOR 1:2
 AB 151/17
 17,5 cm/7"



TAYLOR 1:2
 AB 152/17
 17,5 cm/7"



TAYLOR 1:2
 AB 153/17
 17,5 cm/7"

PINZETTEN FORCEPS PINZAS PINCES PINZE

Anatomische Pinzetten, Chirurgische Pinzetten
 Dressing Forceps, Tissue Forceps
 Pinzas de disección, Pinzas de disección con dientes
 Pincers à dissection, Pincers à griffes
 Pinze anatomiche per dissezione, Pinze chirurgiche a denti di topo



AB 160/18

GERALD
18,0 cm/7"



AB 161/18



AB 170/18

GERALD 1:2
18,0 cm/7"



AB 171/18



AB 180/17

CUSHING
17,5 cm/7"



AB 181/17



AB 190/17

CUSHING 1:2
17,5 cm/7"



AB 191/17

AA
 AB
 AC
 AD
 AE
 AF
 AK
 AL
 AO
 AR
 KA
 KL
 KU
 PA
 PB
 PF
 PI
 PK
 PL
 PM
 PP
 PS
 PT
 PU
 PV
 KYE

AB PINZETTEN FORCEPS PINZAS PINCES PINZE

Splitter-Pinzetten
 Splinter Forceps
 Pinzas para espinas
 Pincès à échardes
 Pinze per schegge

mit Führungsstift
 with guide pin
 con espiga de guía
 avec repères
 con perno da guida



AB 564/10



AB 565/10



AB 566/10



AB 567/10

- 8,0 cm/3" AB 564/08
- 9,0 cm/3¹/₂" AB 564/09
- 10,5 cm/4¹/₄" AB 564/10
- 11,5 cm/4¹/₂" AB 564/11
- 12,5 cm/5" AB 564/12
- 14,5 cm/5³/₄" AB 564/14

- AB 565/08
- AB 565/09
- AB 565/10
- AB 565/11
- AB 565/12
- AB 565/14

- AB 566/08
- AB 566/09
- AB 566/10
- AB 566/11
- AB 566/12
- AB 566/14

- AB 567/08
- AB 567/09
- AB 567/10
- AB 567/11
- AB 567/12
- AB 567/14

PINZETTEN FORCEPS PINZAS PINCES PINZE

Splitter-Pinzetten
 Splinter Forceps
 Pinzas para espinas
 Pincès à écharde
 Pinze per schegge

AA
 AB
 AC
 AD
 AE
 AF
 AG
 AH
 AI
 AJ
 AK
 AL
 AM
 AN
 AO
 AP
 AQ
 AR
 AS
 AT
 AU
 AV
 AW
 AX
 AY
 AZ
 BA
 BB
 BC
 BD
 BE
 BF
 BG
 BH
 BI
 BJ
 BK
 BL
 BM
 BN
 BO
 BP
 BQ
 BR
 BS
 BT
 BU
 BV
 BW
 BX
 BY
 BZ
 CA
 CB
 CC
 CD
 CE
 CF
 CG
 CH
 CI
 CJ
 CK
 CL
 CM
 CN
 CO
 CP
 CQ
 CR
 CS
 CT
 CU
 CV
 CW
 CX
 CY
 CZ
 DA
 DB
 DC
 DD
 DE
 DF
 DG
 DH
 DI
 DJ
 DK
 DL
 DM
 DN
 DO
 DP
 DQ
 DR
 DS
 DT
 DU
 DV
 DW
 DX
 DY
 DZ
 EA
 EB
 EC
 ED
 EE
 EF
 EG
 EH
 EI
 EJ
 EK
 EL
 EM
 EN
 EO
 EP
 EQ
 ER
 ES
 ET
 EU
 EV
 EW
 EX
 EY
 EZ
 FA
 FB
 FC
 FD
 FE
 FF
 FG
 FH
 FI
 FJ
 FK
 FL
 FM
 FN
 FO
 FP
 FQ
 FR
 FS
 FT
 FU
 FV
 FW
 FX
 FY
 FZ
 GA
 GB
 GC
 GD
 GE
 GF
 GG
 GH
 GI
 GJ
 GK
 GL
 GM
 GN
 GO
 GP
 GQ
 GR
 GS
 GT
 GU
 GV
 GW
 GX
 GY
 GZ
 HA
 HB
 HC
 HD
 HE
 HF
 HG
 HH
 HI
 HJ
 HK
 HL
 HM
 HN
 HO
 HP
 HQ
 HR
 HS
 HT
 HU
 HV
 HW
 HX
 HY
 HZ
 IA
 IB
 IC
 ID
 IE
 IF
 IG
 IH
 II
 IJ
 IK
 IL
 IM
 IN
 IO
 IP
 IQ
 IR
 IS
 IT
 IU
 IV
 IW
 IX
 IY
 IZ
 JA
 JB
 JC
 JD
 JE
 JF
 JG
 JH
 JI
 JJ
 JK
 JL
 JM
 JN
 JO
 JP
 JQ
 JR
 JS
 JT
 JU
 JV
 JW
 JX
 JY
 JZ
 KA
 KB
 KC
 KD
 KE
 KF
 KG
 KH
 KI
 KJ
 KK
 KL
 KM
 KN
 KO
 KP
 KQ
 KR
 KS
 KT
 KU
 KV
 KW
 KX
 KY
 KZ
 LA
 LB
 LC
 LD
 LE
 LF
 LG
 LH
 LI
 LJ
 LK
 LL
 LM
 LN
 LO
 LP
 LQ
 LR
 LS
 LT
 LU
 LV
 LW
 LX
 LY
 LZ
 MA
 MB
 MC
 MD
 ME
 MF
 MG
 MH
 MI
 MJ
 MK
 ML
 MM
 MN
 MO
 MP
 MQ
 MR
 MS
 MT
 MU
 MV
 MW
 MX
 MY
 MZ
 NA
 NB
 NC
 ND
 NE
 NF
 NG
 NH
 NI
 NJ
 NK
 NL
 NM
 NN
 NO
 NP
 NQ
 NR
 NS
 NT
 NU
 NV
 NW
 NX
 NY
 NZ
 OA
 OB
 OC
 OD
 OE
 OF
 OG
 OH
 OI
 OJ
 OK
 OL
 OM
 ON
 OO
 OP
 OQ
 OR
 OS
 OT
 OU
 OV
 OW
 OX
 OY
 OZ
 PA
 PB
 PC
 PD
 PE
 PF
 PG
 PH
 PI
 PJ
 PK
 PL
 PM
 PN
 PO
 PP
 PQ
 PR
 PS
 PT
 PU
 PV
 PW
 PX
 PY
 PZ
 QA
 QB
 QC
 QD
 QE
 QF
 QG
 QH
 QI
 QJ
 QK
 QL
 QM
 QN
 QO
 QP
 QQ
 QR
 QS
 QT
 QU
 QV
 QW
 QX
 QY
 QZ
 RA
 RB
 RC
 RD
 RE
 RF
 RG
 RH
 RI
 RJ
 RK
 RL
 RM
 RN
 RO
 RP
 RQ
 RR
 RS
 RT
 RU
 RV
 RW
 RX
 RY
 RZ
 SA
 SB
 SC
 SD
 SE
 SF
 SG
 SH
 SI
 SJ
 SK
 SL
 SM
 SN
 SO
 SP
 SQ
 SR
 SS
 ST
 SU
 SV
 SW
 SX
 SY
 SZ
 TA
 TB
 TC
 TD
 TE
 TF
 TG
 TH
 TI
 TJ
 TK
 TL
 TM
 TN
 TO
 TP
 TQ
 TR
 TS
 TT
 TU
 TV
 TW
 TX
 TY
 TZ
 UA
 UB
 UC
 UD
 UE
 UF
 UG
 UH
 UI
 UJ
 UK
 UL
 UM
 UN
 UO
 UP
 UQ
 UR
 US
 UT
 UY
 UZ
 VA
 VB
 VC
 VD
 VE
 VF
 VG
 VH
 VI
 VJ
 VK
 VL
 VM
 VN
 VO
 VP
 VQ
 VR
 VS
 VT
 VU
 VV
 VW
 VX
 VY
 VZ
 WA
 WB
 WC
 WD
 WE
 WF
 WG
 WH
 WI
 WJ
 WK
 WL
 WM
 WN
 WO
 WP
 WQ
 WR
 WS
 WT
 WU
 WV
 WW
 WX
 WY
 WZ
 XA
 XB
 XC
 XD
 XE
 XF
 XG
 XH
 XI
 XJ
 XK
 XL
 XM
 XN
 XO
 XP
 XQ
 XR
 XS
 XT
 XU
 XV
 XW
 XX
 XY
 XZ
 YA
 YB
 YC
 YD
 YE
 YF
 YG
 YH
 YI
 YJ
 YK
 YL
 YM
 YN
 YO
 YP
 YQ
 YR
 YS
 YT
 YU
 YV
 YW
 YX
 YZ
 ZA
 ZB
 ZC
 ZD
 ZE
 ZF
 ZG
 ZH
 ZI
 ZJ
 ZK
 ZL
 ZM
 ZN
 ZO
 ZP
 ZQ
 ZR
 ZS
 ZT
 ZU
 ZV
 ZW
 ZX
 ZY
 ZZ

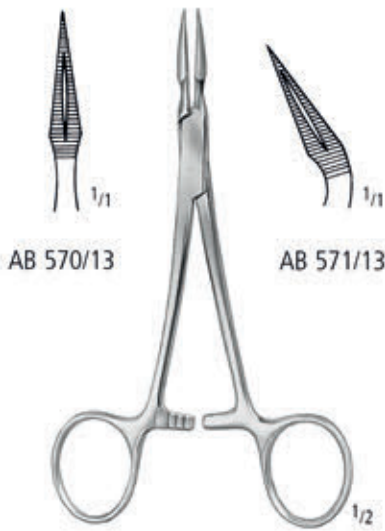

AB 570/13

AB 571/13

STIEGLITZ
 13,5 cm/5 1/4"



STIEGLITZ
 AB 571/90
 13,5 cm/5 1/4"

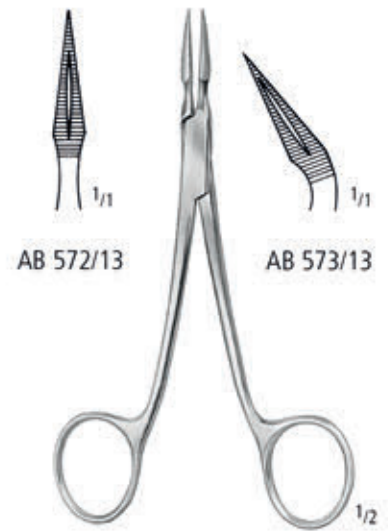

AB 572/13

AB 573/13

STIEGLITZ
 13,5 cm/5 1/4"



SILVER-POINT
 AB 574/13
 12,5 cm/5"



PEET
 AB 580/11
 11,5 cm/4 1/2"

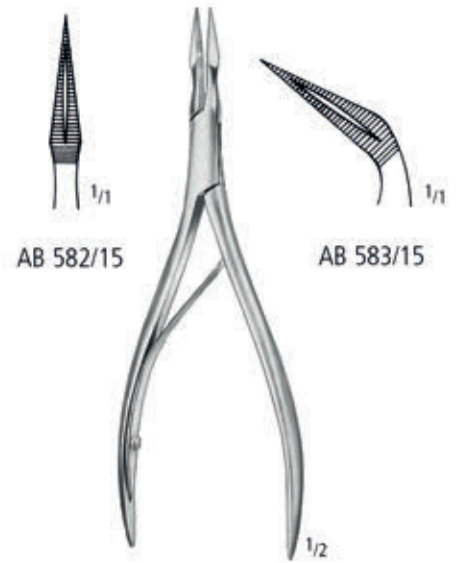

AB 582/15

AB 583/15

RALK
 15,0 cm/6"

Atraumatische Pinzetten
 Non-traumatic Vascular Tissue Forceps
 Pinzas Atrauma
 Pincas Atrauma
 Pinze Atrauma



DE BAKEY
 AB 860/16
 16,0 cm/6¹/₄"



DE BAKEY
 AB 862/16
 16,0 cm/6¹/₄"

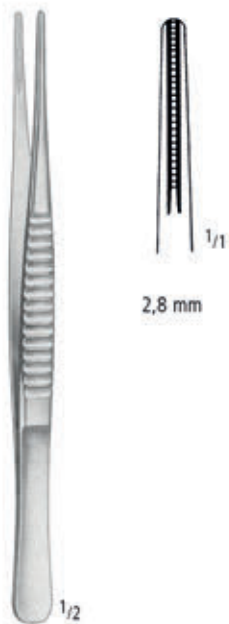

DE BAKEY
 AB 864/16
 16,0 cm/6¹/₄"

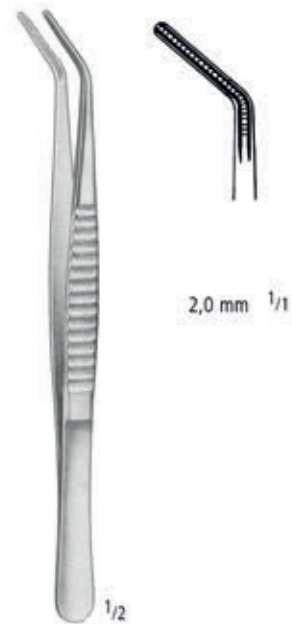

DE BAKEY
 AB 869/16
 16,0 cm/6¹/₄"

PINZETTEN FORCEPS PINZAS PINCES PINZE

Pinzetten mit Hartmetalleinsätzen
 Dissecting Forceps with Tungsten Carbide Inserts
 Pinzas de disección con bocas de carburo de tungsteno
 Pincès à dissection avec mors en carbure de tungstène
 Pinze per dissezione con punte di carburo di tungsteno

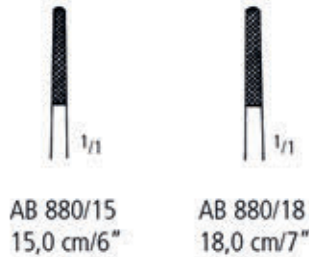

AB 880/15
15,0 cm/6"

AB 880/18
18,0 cm/7"

POTTS-SMITH



AB 882/14
14,0 cm/5 1/2"

AB 882/16
16,0 cm/6 1/4"

AB 882/18
18,0 cm/7"

OEHLER 1:2



AB 890/12

SEMKEN
 AB 890/12 12,5 cm/5"
 AB 890/15 15,5 cm/6"



GILLIES 1:2
 AB 900/15
 15,0 cm/6"



JEWELER
 AB 902/15
 15,0 cm/6"

AA
 AB
 AC
 AD
 AE
 AF
 AK
 AL
 AO
 AR
 KA
 KL
 KU
 PA
 PB
 PF
 PI
 PK
 PL
 PM
 PP
 PS
 PT
 PU
 PV
 KYE

AB PINZETTEN FORCEPS PINZAS PINCES PINZE

Pinzetten mit Hartmetalleinsätzen
 Dissecting Forceps with Tungsten Carbide Inserts
 Pinzas de disección con bocas de carburo de tungsteno
 Pincès à dissection avec mors en carbure de tungstène
 Pinze per dissezione con punte di carburo di tungsteno



ADSON



CUSHING
17,5 cm/7"



mit Dissektor-Ende
 with dissector end
 con cabo disecador
 avec bout dissecteur
 con dissettore



CUSHING-TAYLOR
AB 943/18
18,0 cm/7"

PINZETTEN FORCEPS PINZAS PINCES PINZE

Zahnpinzetten
Cotton and Dressing Pliers
Pinzas para algodón y curaciones
Précelles (Brucelles) pour coton
Pinze per cotone



FIG. 1

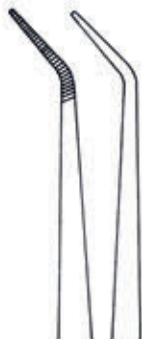

FIG. 3



FIG. 5



FIG. 7



FIG. 8

für Silberspitzen
for silver points
para puntas de plata
pour cônes d'argent
per punte d'argento



2/3

LONDON COLLEGE

15,0 cm/6"
AB 970/01
AB 970/03
AB 970/05

Fig. 1
Fig. 3
Fig. 5
Fig. 7
Fig. 8



2/3

LONDON COLLEGE

15,0 cm/6"
AB 973/01
AB 973/03
AB 973/05
AB 973/07
AB 973/08

AA
AB
AC
AD
AE
AF
AK
AL
AO
AR
KA
KL
KU
PA
PB
PF
PI
PK
PL
PM
PP
PS
PT
PU
PV
KYE

AB PINZETTEN FORCEPS PINZAS PINCES PINZE

Zahnpinzetten
 Cotton and Dressing Pliers
 Pinzas para algodón y curaciones
 Précelles (Brucelles) pour coton
 Pinze per cotone



FIG. 1



FIG. 3



FIG. 5



2/3

MERIAM
 16,0 cm/6¹/₄"
 AB 976/01
 AB 976/03
 AB 976/05



2/3

MERIAM
 16,0 cm/6¹/₄"
 AB 977/01
 AB 977/03
 AB 977/05



2/3

FLAGG
 16,0 cm/6¹/₄"
 AB 978/01
 AB 978/03



2/3

FLAGG
 16,0 cm/6¹/₄"
 AB 979/01
 AB 979/03

Fig. 1
 Fig. 3
 Fig. 5

PINZETTEN FORCEPS PINZAS PINCES PINZE

Zahnpinzetten, Nahtpinzetten
 Cotton and Dressing Pliers, Suture Forceps
 Pinzas para algodón y curaciones, pinzas para sutura
 Précelles (Brucelles) pour coton, pinces pour sutures
 Pinze per cotone, pinze per sutura



2/3

LANDGRAF
 15,0 cm/6"



Fig. 1
 AB 981/01

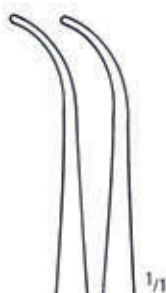

Fig. 2
 AB 981/02



Fig. 3
 AB 981/03



Fig. 4
 AB 981/04



2/3

PERRY
 12,5 cm/5"



Fig. 1
 AB 983/01



Fig. 2
 AB 983/02



15,0 cm/6"



AB 988/01



AB 988/02

AA
 AB
 AC
 AD
 AE
 AF
 AG
 AH
 AI
 AJ
 AK
 AL
 AO
 AP
 AQ
 AR
 AS
 AT
 AU
 AV
 AW
 AX
 AY
 AZ
 BA
 BB
 BC
 BD
 BE
 BF
 BG
 BH
 BI
 BJ
 BK
 BL
 BM
 BN
 BO
 BP
 BQ
 BR
 BS
 BT
 BU
 BV
 BW
 BX
 BY
 BZ
 CA
 CB
 CC
 CD
 CE
 CF
 CG
 CH
 CI
 CJ
 CK
 CL
 CM
 CN
 CO
 CP
 CQ
 CR
 CS
 CT
 CU
 CV
 CW
 CX
 CY
 CZ
 DA
 DB
 DC
 DD
 DE
 DF
 DG
 DH
 DI
 DJ
 DK
 DL
 DM
 DN
 DO
 DP
 DQ
 DR
 DS
 DT
 DU
 DV
 DW
 DX
 DY
 DZ
 EA
 EB
 EC
 ED
 EE
 EF
 EG
 EH
 EI
 EJ
 EK
 EL
 EM
 EN
 EO
 EP
 EQ
 ER
 ES
 ET
 EU
 EV
 EW
 EX
 EY
 EZ
 FA
 FB
 FC
 FD
 FE
 FF
 FG
 FH
 FI
 FJ
 FK
 FL
 FM
 FN
 FO
 FP
 FQ
 FR
 FS
 FT
 FU
 FV
 FW
 FX
 FY
 FZ
 GA
 GB
 GC
 GD
 GE
 GF
 GG
 GH
 GI
 GJ
 GK
 GL
 GM
 GN
 GO
 GP
 GQ
 GR
 GS
 GT
 GU
 GV
 GW
 GX
 GY
 GZ
 HA
 HB
 HC
 HD
 HE
 HF
 HG
 HH
 HI
 HJ
 HK
 HL
 HM
 HN
 HO
 HP
 HQ
 HR
 HS
 HT
 HU
 HV
 HW
 HX
 HY
 HZ
 IA
 IB
 IC
 ID
 IE
 IF
 IG
 IH
 II
 IJ
 IK
 IL
 IM
 IN
 IO
 IP
 IQ
 IR
 IS
 IT
 IU
 IV
 IW
 IX
 IY
 IZ
 JA
 JB
 JC
 JD
 JE
 JF
 JG
 JH
 JI
 JJ
 JK
 JL
 JM
 JN
 JO
 JP
 JQ
 JR
 JS
 JT
 JU
 JV
 JW
 JX
 JY
 JZ
 KA
 KB
 KC
 KD
 KE
 KF
 KG
 KH
 KI
 KJ
 KK
 KL
 KM
 KN
 KO
 KP
 KQ
 KR
 KS
 KT
 KU
 KV
 KW
 KX
 KY
 KZ
 LA
 LB
 LC
 LD
 LE
 LF
 LG
 LH
 LI
 LJ
 LK
 LL
 LM
 LN
 LO
 LP
 LQ
 LR
 LS
 LT
 LU
 LV
 LW
 LX
 LY
 LZ
 MA
 MB
 MC
 MD
 ME
 MF
 MG
 MH
 MI
 MJ
 MK
 ML
 MM
 MN
 MO
 MP
 MQ
 MR
 MS
 MT
 MU
 MV
 MW
 MX
 MY
 MZ
 NA
 NB
 NC
 ND
 NE
 NF
 NG
 NH
 NI
 NJ
 NK
 NL
 NM
 NN
 NO
 NP
 NQ
 NR
 NS
 NT
 NU
 NV
 NW
 NX
 NY
 NZ
 OA
 OB
 OC
 OD
 OE
 OF
 OG
 OH
 OI
 OJ
 OK
 OL
 OM
 ON
 OO
 OP
 OQ
 OR
 OS
 OT
 OU
 OV
 OW
 OX
 OY
 OZ
 PA
 PB
 PC
 PD
 PE
 PF
 PG
 PH
 PI
 PJ
 PK
 PL
 PM
 PN
 PO
 PP
 PQ
 PR
 PS
 PT
 PU
 PV
 PW
 PX
 PY
 PZ
 QA
 QB
 QC
 QD
 QE
 QF
 QG
 QH
 QI
 QJ
 QK
 QL
 QM
 QN
 QO
 QP
 QQ
 QR
 QS
 QT
 QU
 QV
 QW
 QX
 QY
 QZ
 RA
 RB
 RC
 RD
 RE
 RF
 RG
 RH
 RI
 RJ
 RK
 RL
 RM
 RN
 RO
 RP
 RQ
 RR
 RS
 RT
 RU
 RV
 RW
 RX
 RY
 RZ
 SA
 SB
 SC
 SD
 SE
 SF
 SG
 SH
 SI
 SJ
 SK
 SL
 SM
 SN
 SO
 SP
 SQ
 SR
 SS
 ST
 SU
 SV
 SW
 SX
 SY
 SZ
 TA
 TB
 TC
 TD
 TE
 TF
 TG
 TH
 TI
 TJ
 TK
 TL
 TM
 TN
 TO
 TP
 TQ
 TR
 TS
 TT
 TU
 TV
 TW
 TX
 TY
 TZ
 UA
 UB
 UC
 UD
 UE
 UF
 UG
 UH
 UI
 UJ
 UK
 UL
 UM
 UN
 UO
 UP
 UQ
 UR
 US
 UT
 UY
 UZ
 VA
 VB
 VC
 VD
 VE
 VF
 VG
 VH
 VI
 VJ
 VK
 VL
 VM
 VN
 VO
 VP
 VQ
 VR
 VS
 VT
 VY
 VZ
 WA
 WB
 WC
 WD
 WE
 WF
 WG
 WH
 WI
 WJ
 WK
 WL
 WM
 WN
 WO
 WP
 WQ
 WR
 WS
 WT
 WY
 WZ
 XA
 XB
 XC
 XD
 XE
 XF
 XG
 XH
 XI
 XJ
 XK
 XL
 XM
 XN
 XO
 XP
 XQ
 XR
 XS
 XT
 XU
 XV
 XW
 XX
 XY
 XZ
 YA
 YB
 YC
 YD
 YE
 YF
 YG
 YH
 YI
 YJ
 YK
 YL
 YM
 YN
 YO
 YP
 YQ
 YR
 YS
 YT
 YZ
 ZA
 ZB
 ZC
 ZD
 ZE
 ZF
 ZG
 ZH
 ZI
 ZJ
 ZK
 ZL
 ZM
 ZN
 ZO
 ZP
 ZQ
 ZR
 ZS
 ZT
 ZY
 ZZ

AB PINZETTEN FORCEPS PINZAS PINCES PINZE

Markierungspinzetten, Artikulationspapier-Pinzetten
 Pocket Markers, Articulating Paper Forceps
 Pinzas para bolsas, Pinzas para papel de articular
 Pincés pour cul-de-sac, Pincés pour papier à articulation
 Pinze per marcazione, Pinze per carta di articolazione

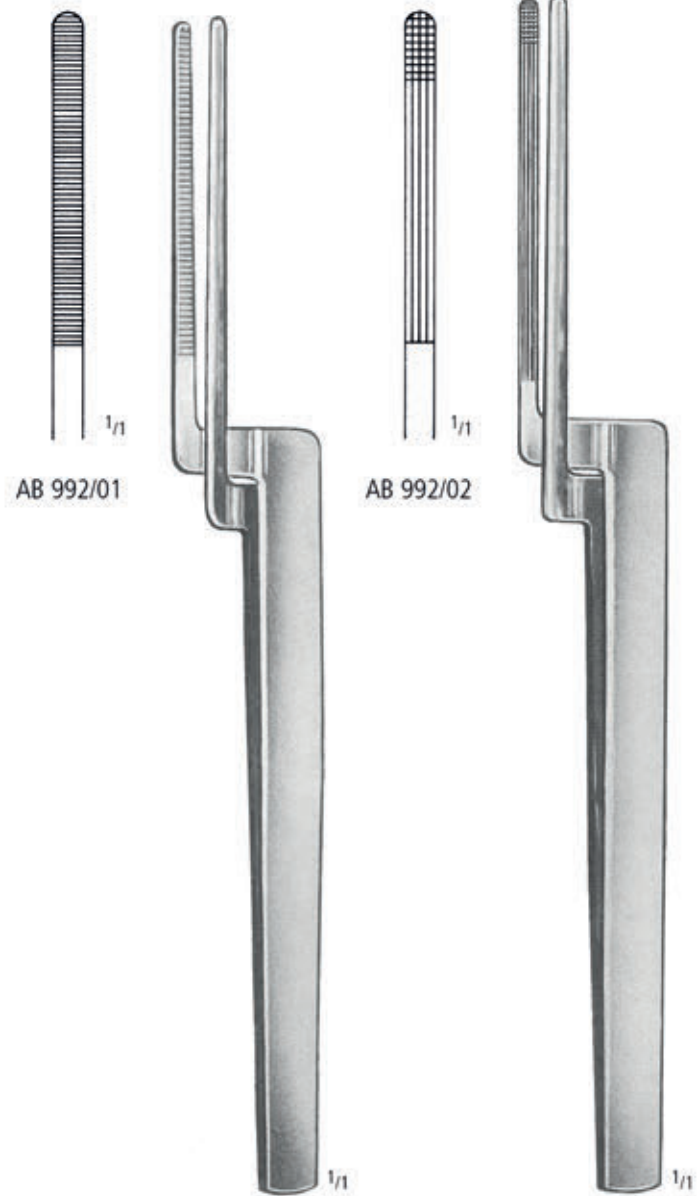
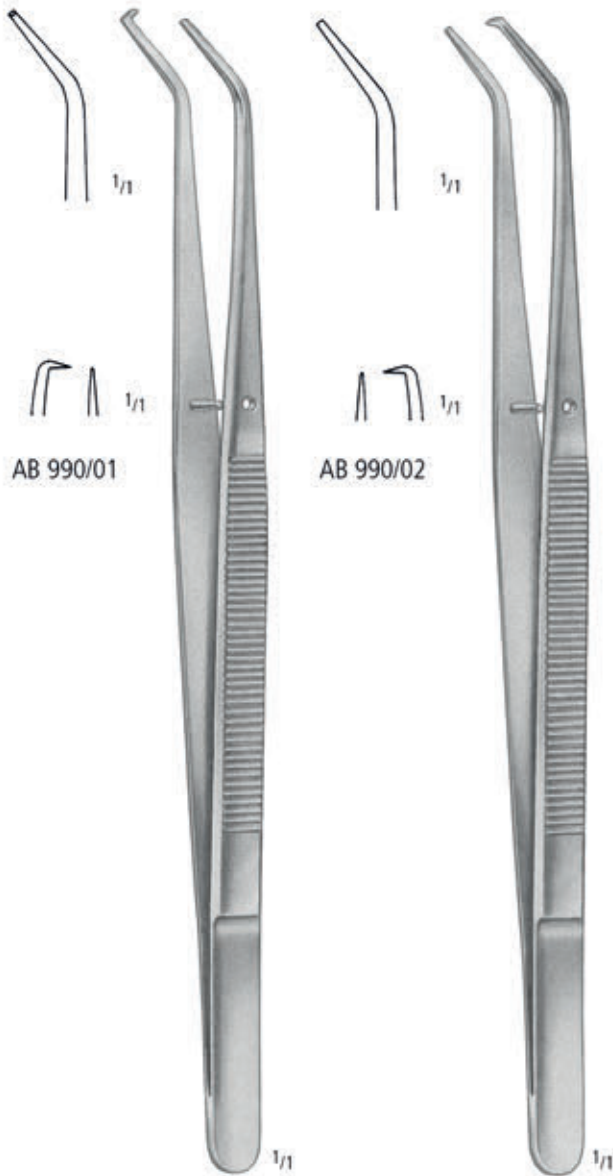

CRANE-KAPLAN

AB 990/01
15,0 cm/6"

AB 990/02
15,0 cm/6"

MILLER

15,0 cm/6"

SCHEREN
SCISSORS
TIJERAS
CISEAUX
FORBICI

AC

nopa[®] instruments



nopa® SC SUPER CUT



SUPER CUT

Verfügbare Modelle / Available Patterns

Im Katalog durch * markiert. / Marked in catalog with * .

AC 020/13 SC	STANDARD OPER.SCS.STR.SH/BL	13,0 CM SC
AC 020/14 SC	STANDARD OPER.SCS.STR.SH/BL	14,0 CM SC
AC 021/13 SC	STANDARD OPER.SCS.CVD.SH/BL	13,0 CM SC
AC 021/14 SC	STANDARD OPER.SCS.CVD.SH/BL	14,0 CM SC
AC 070/14 SC	MAYO OPER.SCS.STR.BL/BL	14,5 CM SC
AC 070/17 SC	MAYO OPER.SCS.STR.BL/BL	17,0 CM SC
AC 071/14 SC	MAYO OPER.SCS.CVD.BL/BL	14,5 CM SC
AC 071/17 SC	MAYO OPER.SCS.CVD.BL/BL	17,0 CM SC
AC 100/14 SC	METZENBAUM SCISSORS STR.BL/BL	14,0 CM SC
AC 101/14 SC	METZENBAUM SCISSORS CVD.BL/BL	14,0 CM SC
AC 110/18 SC	METZENBAUM-NELSON SCS.BL/BL	18,0 CM SC
AC 111/18 SC	METZENBAUM-NELSON SCS.CVD.	18,0 CM SC
AC 140/14 SC	METZENBAUM-DELICATE BL/BL STR.	14,5 CM SC
AC 141/14 SC	METZENBAUM-DELICATE BL/BL CVD.	14,5 CM SC
AC 142/14 SC	METZENBAUM-DELICATE SH/SH STR.	14,5 CM SC
AC 143/14 SC	METZENBAUM-DELICATE SH/SH CVD.	14,5 CM SC
AC 150/18 SC	METZENBAUM-DELICATE BL/BL STR.	18,0 CM SC
AC 151/18 SC	METZENBAUM-DELICATE BL/BL CVD.	18,0 CM SC
AC 152/18 SC	METZENBAUM-DELICATE SH/SH STR.	18,0 CM SC
AC 153/18 SC	METZENBAUM-DELICATE SH/SH CVD.	18,0 CM SC
AC 214/15 SC	REYNOLDS DISS.SCISSORS STR.SH	15,0 CM SC
AC 214/18 SC	REYNOLDS DISS.SCISSORS STR. SHARP	18,0 CM SC
AC 215/15 SC	REYNOLDS DISS.SCISSORS CVD. SHARP	15,0 CM SC
AC 215/18 SC	REYNOLDS DISS.SCS. CVD. SHARP	18,0 CM SC
AC 476/11 SC	STEVENS TENOTOM.SCS.STR. BLUNT	11,5 CM SC

Besonderheit:

nopa Super Cut Scheren haben eine rasierklingenscharfe Schneide, kombiniert mit einer mikrogezahnten Schneide.

>> Diese Scheren sind durch schwarze Ringe gekennzeichnet.

Features:

nopa Super Cut scissors have a razor-like edge combined with one micro serrated blade.

>> Black rings for easy identification.

Chirurgische Scheren
Operating Scissors
Tijeras para cirugía
Ciseaux à chirurgie
Forbici per chirurgia



Original 13,0 cm

STANDARD

Fig.1
gerade
straight
rectas
droits
rette

AC 010/10	10,5 cm/4 ¹ / ₄ "
AC 010/11	11,5 cm/4 ¹ / ₂ "
AC 010/13	13,0 cm/5"
AC 010/14	14,5 cm/5 ³ / ₄ "
AC 010/15	15,5 cm/6"
AC 010/16	16,5 cm/6 ¹ / ₂ "
AC 010/17	17,5 cm/7"
AC 010/18	18,5 cm/7 ¹ / ₃ "
AC 010/20	20,0 cm/8"

STANDARD Original 13,0 cm

Fig.1
gebogen
curved
curvas
courbes
curve



Original 14,5 cm

STANDARD

Fig.2
gerade
straight
rectas
droits
rette

AC 020/10	10,5 cm/4 ¹ / ₄ "
AC 020/11	11,5 cm/4 ¹ / ₂ "
AC 020/13*	13,0 cm/5"
AC 020/14*	14,5 cm/5 ³ / ₄ "
AC 020/15	15,5 cm/6"
AC 020/16	16,5 cm/6 ¹ / ₂ "
AC 020/17	17,5 cm/7"
AC 020/18	18,5 cm/7 ¹ / ₃ "
AC 020/20	20,0 cm/8"

STANDARD Original 14,5 cm

Fig.2
gebogen
curved
curvas
courbes
curve



Original 16,5 cm

STANDARD

Fig.3
gerade
straight
rectas
droits
rette

AC 030/10	10,5 cm/4 ¹ / ₄ "
AC 030/11	11,5 cm/4 ¹ / ₂ "
AC 030/13	13,0 cm/5"
AC 030/14	14,5 cm/5 ³ / ₄ "
AC 030/15	15,5 cm/6"
AC 030/16	16,5 cm/6 ¹ / ₂ "
AC 030/17	17,5 cm/7"
AC 030/18	18,5 cm/7 ¹ / ₃ "
AC 030/20	20,0 cm/8"

STANDARD

Fig.3
gebogen
curved
curvas
courbes
curve

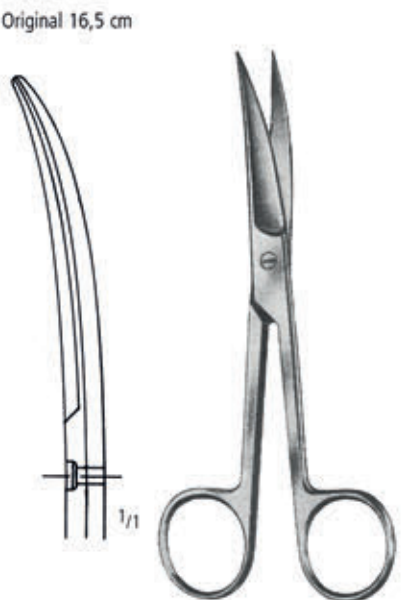

Original 16,5 cm

SCHEREN SCISSORS TIJERAS CISEAUX FORBICI

Chirurgische Scheren
Operating Scissors
Tijeras para cirugía
Ciseaux à chirurgie
Forbici per chirurgia



GRAZIL

Fig. 1
gerade
straight
rectas
droits
rette

AC 040/13
AC 040/14

13,0 cm/5"
14,5 cm/5³/₄"



GRAZIL

Fig. 1
gebogen
curved
curvas
courbes
curve

AC 041/13
AC 041/14



GRAZIL

Fig. 2
gerade
straight
rectas
droits
rette

AC 042/13
AC 042/14

13,0 cm/5"
14,5 cm/5³/₄"



GRAZIL

Fig. 2
gebogen
curved
curvas
courbes
curve

AC 043/13
AC 043/14



GRAZIL

Fig. 3
gerade
straight
rectas
droits
rette

AC 046/13
AC 046/14

13,0 cm/5"
14,5 cm/5³/₄"



GRAZIL

Fig. 3
gebogen
curved
curvas
courbes
curve

AC 047/13
AC 047/14

AA
AB
AC
AD
AE
AF
AK
AL
AO
AR
KA
KL
KU
PA
PB
PF
PI
PK
PL
PM
PP
PS
PT
PU
PV
KYE

Chirurgische Scheren
 Operating Scissors
 Tijeras para cirugía
 Ciseaux à chirurgie
 Forbici per chirurgia

Original 15,0 cm

Original 16,0 cm

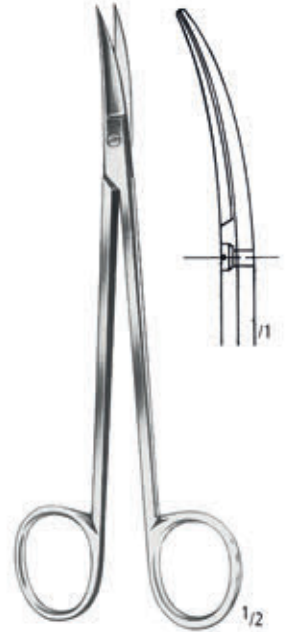
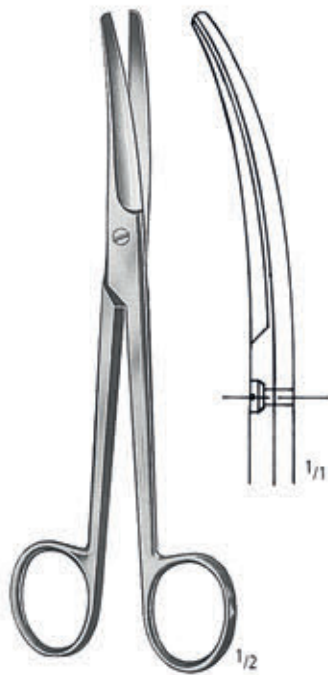

MAYO

AC 070/14* 14,5 cm/5³/₄"
 AC 070/17* 17,0 cm/6³/₄"

AC 071/14*
 AC 071/17*

KELLY

AC 086/16 16,0 cm/6¹/₄"
 AC 086/18 18,0 cm/7"

AC 087/16
 AC 087/18

SCHEREN SCISSORS TIJERAS CISEAUX FORBICI

Präparierscheren
Dissecting Scissors
Tijeras para preparaciones
Ciseaux à dissection
Forbici per preparazioni

AA
AB
AC
AD
AE
AF
AK
AL
AO
AR
KA
KL
KU
PA
PB
PF
PI
PK
PL
PM
PP
PS
PT
PU
PV
KYE



Fig. 1
gerade
straight
rectas
droits
rette



Fig. 1
gebogen
curved
curvas
courbes
curve

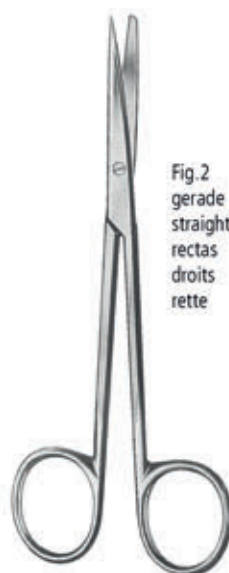

Fig. 2
gerade
straight
rectas
droits
rette

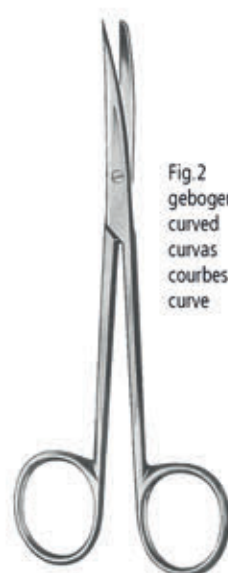

Fig. 2
gebogen
curved
curvas
courbes
curve



METZENBAUM

AC 100/14*
14,5 cm/5³/₄"

AC 101/14*
14,5 cm/5³/₄"

METZENBAUM

AC 102/14
14,5 cm/5³/₄"

AC 103/14
14,5 cm/5³/₄"



Fig. 3
gerade
straight
rectas
droits
rette

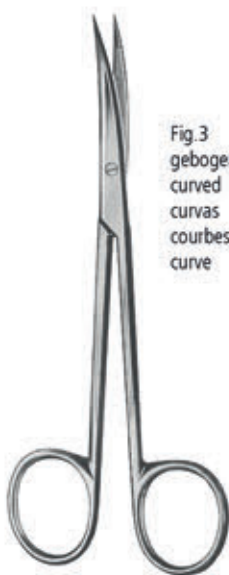
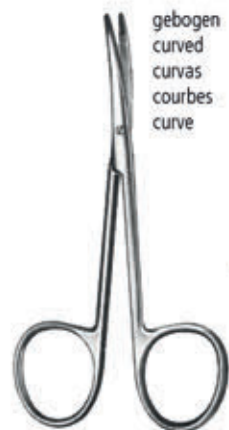

Fig. 3
gebogen
curved
curvas
courbes
curve



gerade
straight
rectas
droits
rette



gebogen
curved
curvas
courbes
curve



METZENBAUM

AC 104/14
14,5 cm/5³/₄"

AC 105/14
14,5 cm/5³/₄"

METZENBAUM-BABY

AC 108/11

AC 109/11

11,5 cm/4¹/₂"

Präparierscheren
 Dissecting Scissors
 Tijeras para preparaciones
 Ciseaux à dissection
 Forbici per preparazioni



METZENBAUM-NELSON



METZENBAUM-NELSON



Fig. 1



Fig. 2



Fig. 3

18,0 cm/7"

AC 110/18*

AC 111/18*

AC 120/18

AC 121/18

AC 130/18

AC 131/18

Präparierscheren, DELICATE
 Dissecting Scissors, DELICATE
 Tijeras para preparaciones, DELICATE
 Ciseaux à dissection, DELICATE
 Forbici per preparazioni, DELICATE

METZENBAUM-DELICATE



Fig. 1
 AC 140/14*
 14,5 cm/5³/₄"



Fig. 1
 AC 141/14*
 14,5 cm/5³/₄"



Fig. 3
 AC 142/14*
 14,5 cm/5³/₄"



Fig. 3
 AC 143/14*
 14,5 cm/5³/₄"

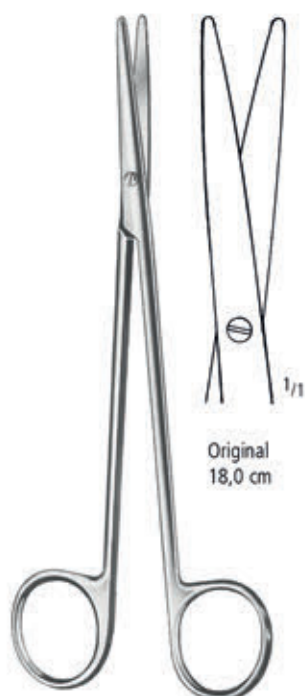

18,0 cm/7"
 Fig. 1
 AC 150/18*

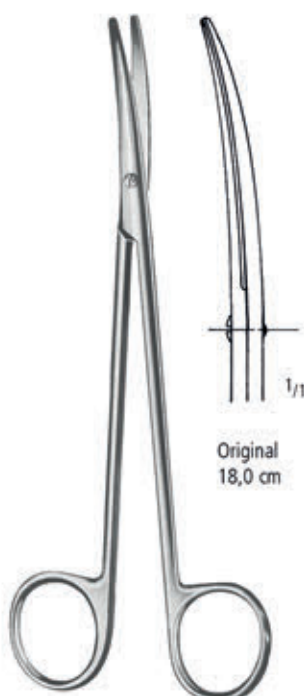

Fig. 1
 AC 151/18*

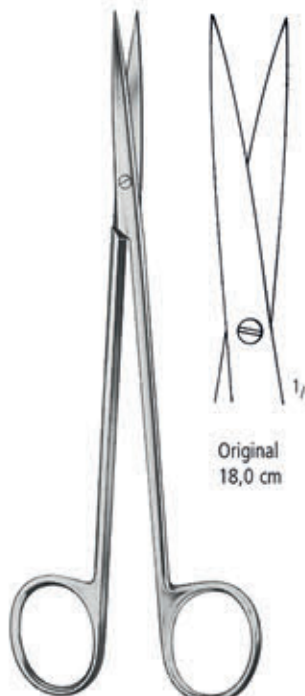

Fig. 3
 AC 152/18*

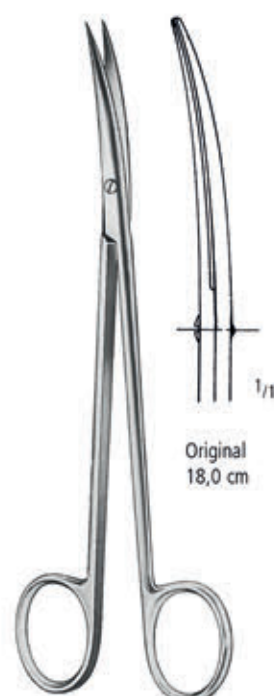
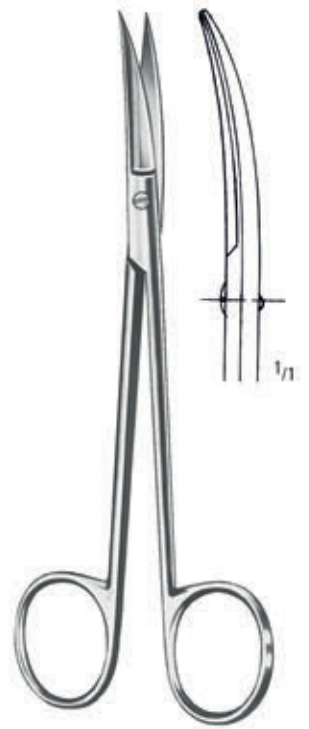
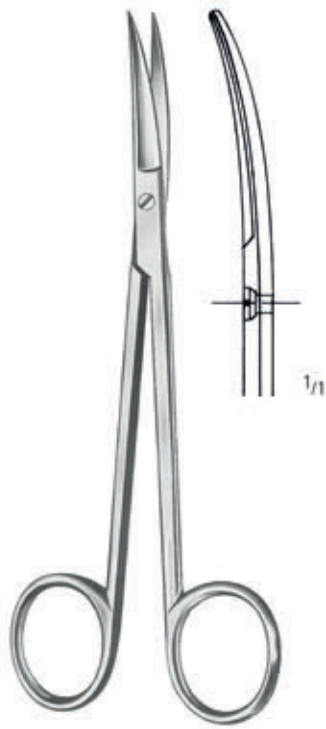

Fig. 3
 AC 153/18*

AC SCHEREN SCISSORS TIJERAS CISEAUX FORBICI

Präparierscheren
Dissecting Scissors
Tijeras para preparaciones
Ciseaux à dissection
Forbici per preparazioni



SANVENERO

AC 200/14
14,0 cm/5 1/2"

AC 201/14
14,0 cm/5 1/2"

JOSEPH

AC 204/14
14,0 cm/5 1/2"

AC 205/14
14,0 cm/5 1/2"

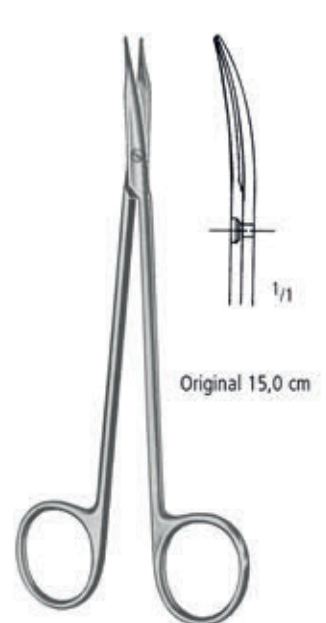
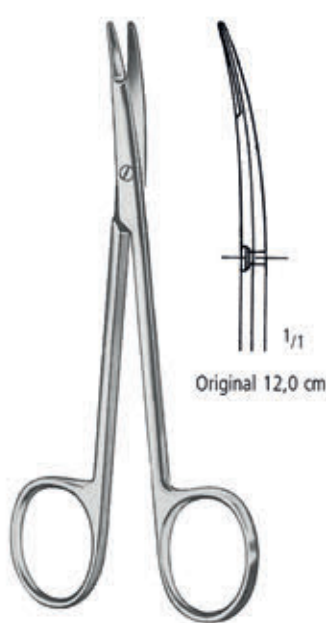

KILNER (RAGNELL)

AC 208/12	12,0 cm/4 3/4"	AC 210/12
AC 208/15	15,0 cm/6"	AC 210/15
AC 208/18	18,0 cm/7"	AC 210/18

REYNOLDS

AC 214/15*	15,0 cm/6"	AC 215/15*
AC 214/18*	18,0 cm/7"	AC 215/18*

SCHEREN SCISSORS TIJERAS CISEAUX FORBICI

Feine chirurgische Scheren
 Fine Operating Scissors
 Tijeras finas para cirugía
 Ciseaux fins à chirurgie
 Forbici fini per chirurgia



WAGNER
 12,0 cm/4³/₄"

gerade
 straight
 rectas
 droits
 rette



Fig. 1
 AC 404/01



Fig. 2
 AC 404/02



Fig. 3
 AC 404/03

gebogen
 curved
 curvas
 courbes
 curve



Fig. 1
 AC 405/01



Fig. 2
 AC 405/02



Fig. 3
 AC 405/03



AC 408/11
 11,0 cm/4¹/₃"



AC 409/11
 11,0 cm/4¹/₃"



BROPHY (SULLIVAN)
 AC 414/14
 14,5 cm/5³/₄"



AC 415/14
 14,5 cm/5³/₄"

AA
 AB
 AC
 AD
 AE
 AF
 AK
 AL
 AO
 AR
 KA
 KL
 KU
 PA
 PB
 PF
 PI
 PK
 PL
 PM
 PP
 PS
 PT
 PU
 PV
 KYE

AC SCHEREN SCISSORS TIJERAS CISEAUX FORBICI

Feine Scheren
 Fine Scissors
 Tijeras finas
 Ciseaux fins
 Forbici fini



11,5 cm/4 1/2"

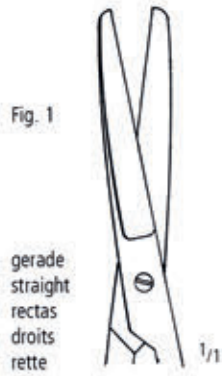

AC 446/01

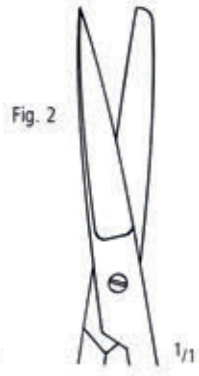

AC 446/02

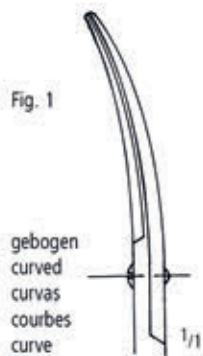

AC 447/01



AC 447/02



AC 448/11
 11,5 cm/4 1/2"



AC 449/11
 11,5 cm/4 1/2"



9,0 cm/3 1/2"
 10,5 cm/4 1/4"
 11,5 cm/4 1/2"

AC 450/09
 AC 450/10
 AC 450/11

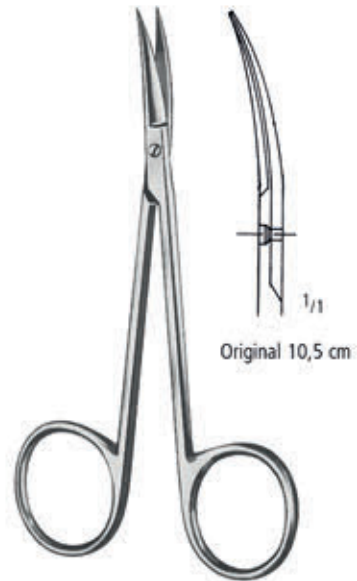

AC 451/09
 AC 451/10
 AC 451/11

SCHEREN SCISSORS TIJERAS CISEAUX FORBICI

Feine Scheren
Fine Scissors
Tijeras finas
Ciseaux fins
Forbici fini

mit großen Ringen
with large bows
con anillos grandes
avec grands anneaux
con anelli grandi

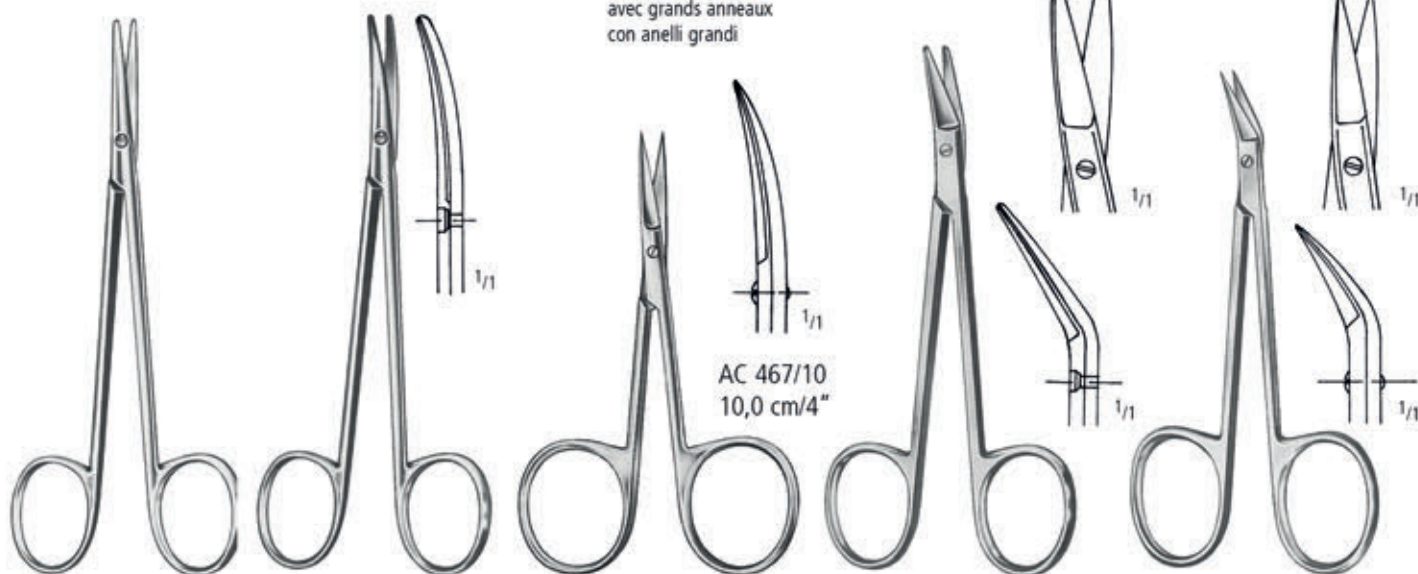

AC 460/11
11,5 cm/4 1/2"

AC 461/11
11,5 cm/4 1/2"

AC 466/10
10,0 cm/4"

AC 467/10
10,0 cm/4"

GRAEFE
AC 469/10
10,5 cm/4 1/4"

WILMER
AC 471/10
10,0 cm/4"



Original 11,5 cm

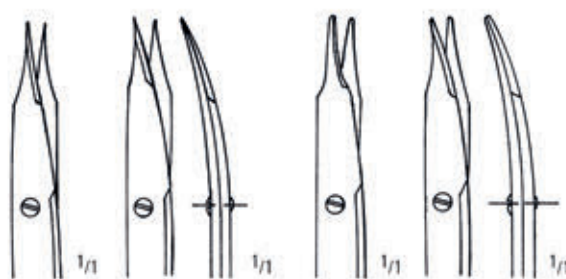

spitz
pointed
agudas
pointues
acuta

stumpf
blunt
romas
mousses
smussa

gerade
straight
rectas
droits
rette

gebogen
curved
curvas
courbes
curve

gerade
straight
rectas
droits
rette

gebogen
curved
curvas
courbes
curve

LA GRANGE
AC 472/11
11,5 cm/4 1/2"

CHADWICK
AC 473/11
11,0 cm/4 1/3"

STEVENS
10,5 cm/4 1/4"
11,5 cm/4 1/2"

AC 474/10
AC 474/11

AC 475/10
AC 475/11

AC 476/10
AC 476/11*

AC 477/10
AC 477/11

* Auch erhältlich als SC * Also available as SC

AA
AB
AC
AD
AE
AF
AK
AL
AO
AR
KA
KL
KU
PA
PB
PF
PI
PK
PL
PM
PP
PS
PT
PU
PV
KYE

AC SCHEREN SCISSORS TIJERAS CISEAUX FORBICI

Ligaturscheren
Ligature Scissors
Tijeras para ligaduras
Ciseaux à ligatures
Forbici per legatura



SPENCER

9,0 cm/3¹/₂" AC 500/09
10,5 cm/4¹/₄" AC 500/10
12,5 cm/5" AC 500/13



SPENCER-DELICATE

AC 501/11
11,0 cm/4¹/₃"



LITTAUER

AC 502/14
14,0 cm/5¹/₂"



AC 503/16
16,0 cm/6¹/₄"



EISELSBERG

AC 504/12
11,0 cm/4¹/₃"



SCHOEMAKER-LOTH

AC 505/12
12,5 cm/5"



AC 506/11
11,5 cm/4¹/₂"

SCHEREN SCISSORS TIJERAS CISEAUX FORBICI

Draht- und Kronenscheren
 Wire Cutting and Crown Scissors
 Cizallas para cortar alambre, Tijeras para coronas
 Cisailles pour fils, Ciseaux à couronnes
 Forbici per filo metallico e per corone

AA
AB
AC
AD
AE
AF
AK
AL
AO
AR
KA
KL
KU
PA
PB
PF
PI
PK
PL
PM
PP
PS
PT
PU
PV
KYE



HARVEY
 AC 520/12
 12,5 cm/5"



SCHUKNECHT
 AC 521/10
 10,0 cm/4"



AC 522/11
 11,0 cm/4 1/3"



UNIVERSAL
 AC 524/12
 12,0 cm/4 3/4"



SMITH
 AC 525/17
 17,5 cm/7"

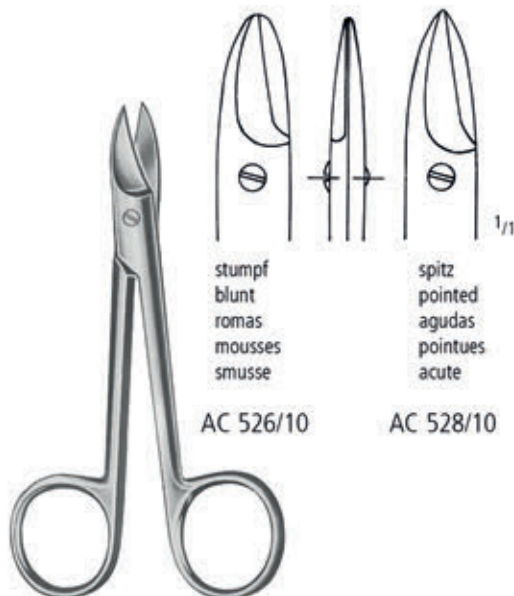

BEEBEE
 10,5 cm/4 1/4"
 gerade - straight - rectas - droits - rette

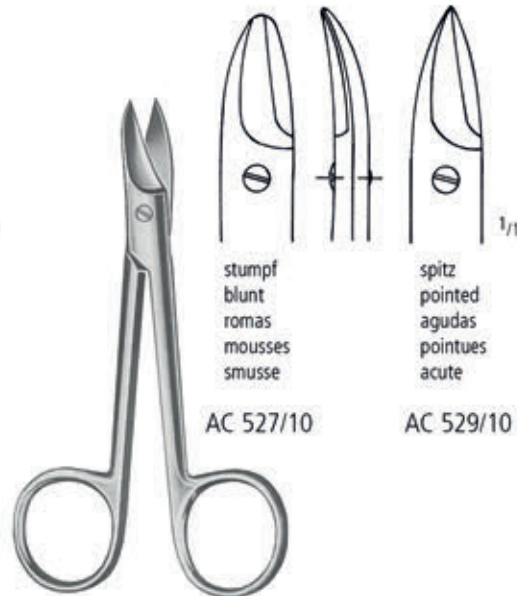

BEEBEE
 10,5 cm/4 1/4"
 gebogen - curved - curvas - courbes - curve

AC SCHEREN SCISSORS TIJERAS CISEAUX FORBICI

Kronenscheren
 Crown Scissors
 Tijeras para coronas
 Ciseaux à couronnes
 Forbici per corone

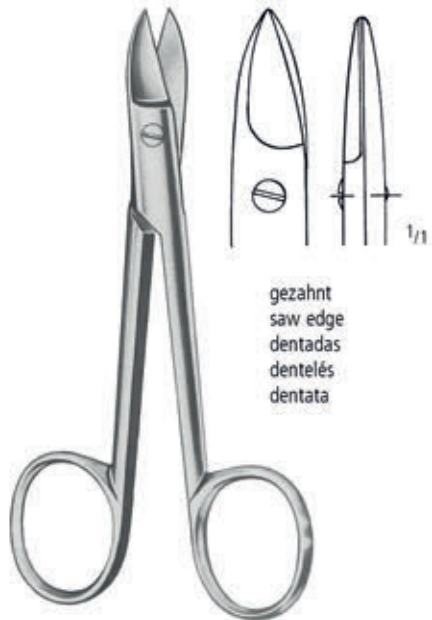

gezahnt
 saw edge
 dentadas
 dentelés
 dentata

BEEBEE
 AC 530/12
 12,0 cm/4³/₄"

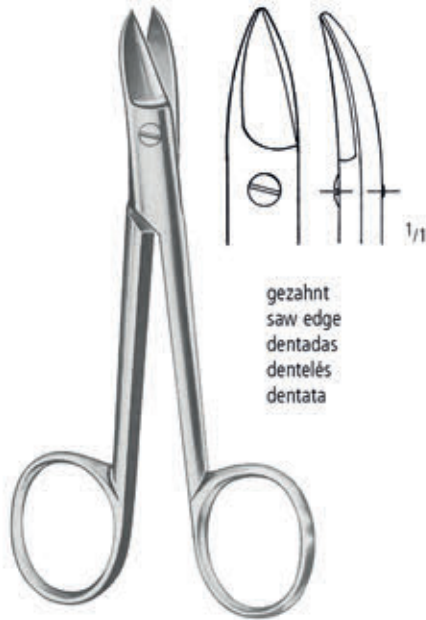

gezahnt
 saw edge
 dentadas
 dentelés
 dentata

BEEBEE
 AC 531/12
 12,0 cm/4³/₄"



AC 535/10
 10,5 cm/4¹/₄"



AC 536/09
 9,0 cm/3¹/₂"



AC 537/09
 9,0 cm/3¹/₂"



AC 538/11
 11,0 cm/4¹/₃"



AC 539/11
 11,0 cm/4¹/₃"

SCHEREN SCISSORS TIJERAS CISEAUX FORBICI

Zahnfleischscheren
Gum Scissors
Tijeras para encias
Ciseaux à gencives
Forbici per gengiva

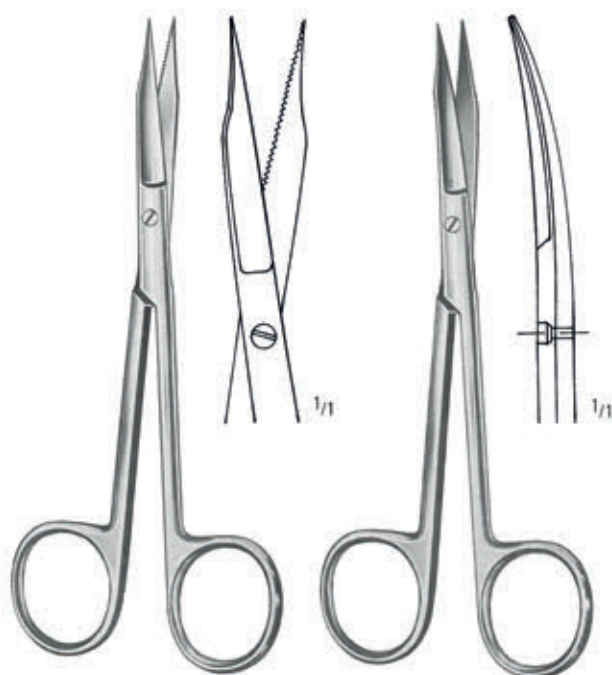

GOLDMAN-FOX

AC 630/13
13,0 cm/5"

AC 631/13
13,0 cm/5"

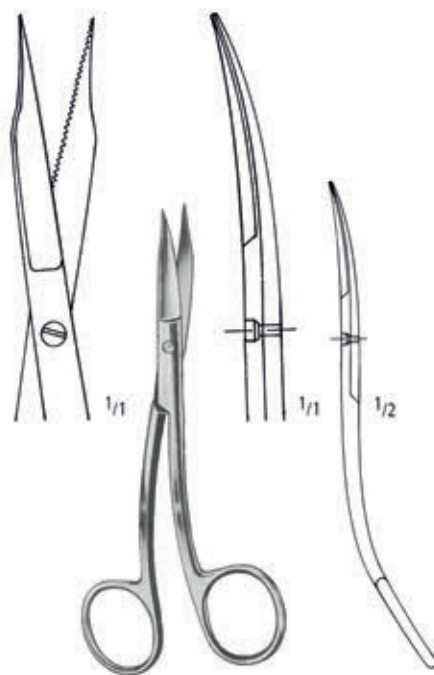

GOLDMAN-FOX (SPEZIAL)

AC 635/13
13,0 cm/5"



AC 637/11
11,5 cm/4 1/2"

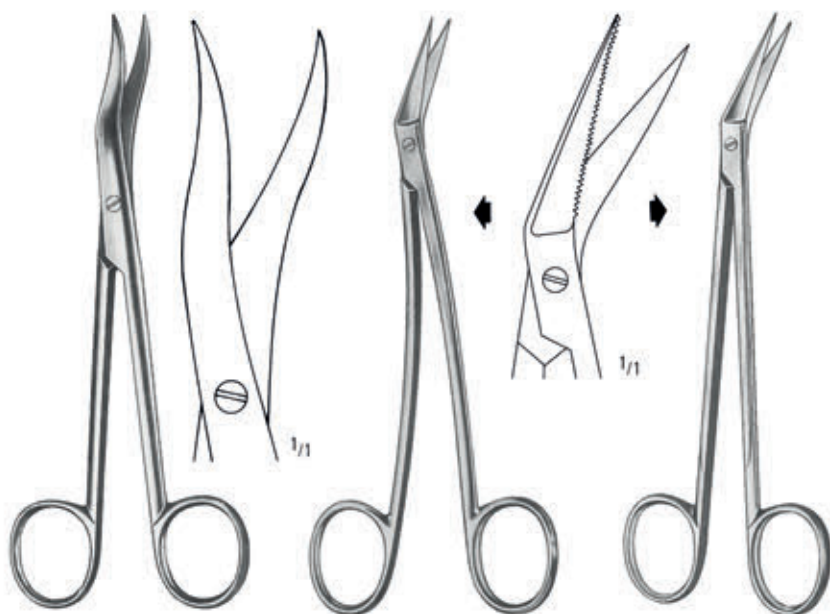

AC 639/16
16,0 cm/6 1/4"

LOCKLIN
AC 640/16
16,5 cm/6 1/2"

LOCKLIN
AC 641/16
16,5 cm/6 1/2"

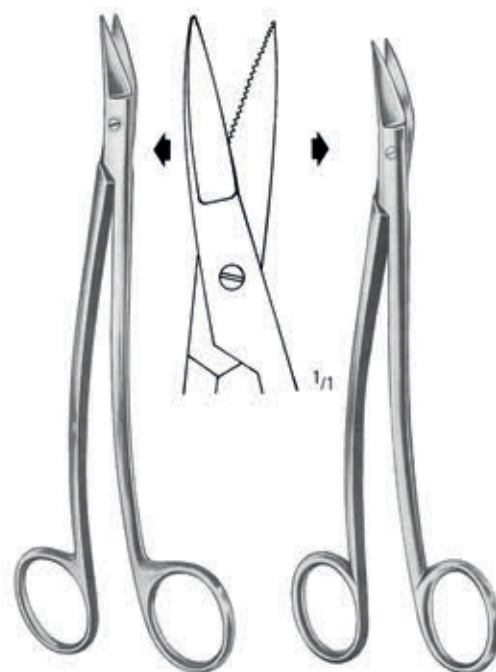

DEAN-DELICATE
AC 642/17
17,0 cm/6 3/4"

DEAN
AC 643/17
17,0 cm/6 3/4"

AA
AB
AC
AD
AE
AF
AK
AL
AO
AR
KA
KL
KU
PA
PB
PF
PI
PK
PL
PM
PP
PS
PT
PU
PV
KYE

AC SCHEREN SCISSORS TIJERAS CISEAUX FORBICI

Zahnfleissscheren
 Gum Scissors
 Tijeras para encias
 Ciseaux à gencives
 Forbici per gengiva



QUINBY

AC 646/12
 12,0 cm/4³/₄"

AC 647/12
 12,0 cm/4³/₄"



STANDARD

AC 648/11
 11,0 cm/4¹/₃"

AC 649/11
 11,0 cm/4¹/₃"

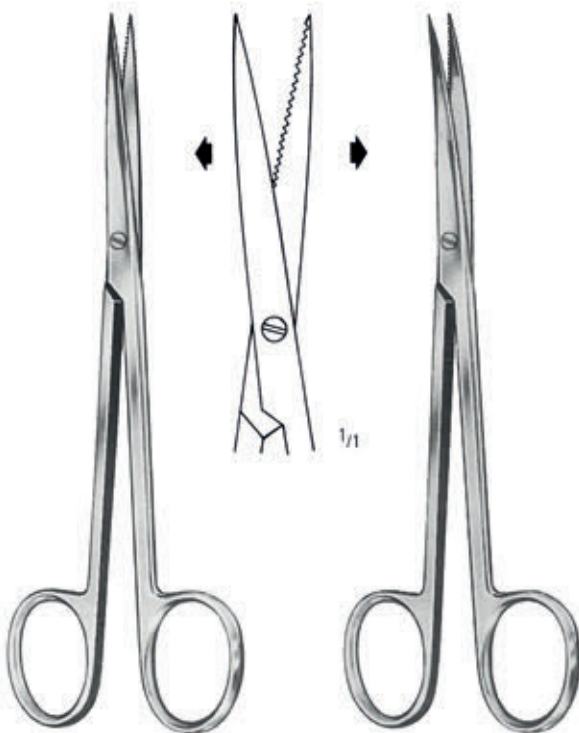

SULLIVAN

AC 650/14
 14,5 cm/5³/₄"

AC 651/14
 14,5 cm/5³/₄"



NEUMANN

AC 653/12
 12,5 cm/5"

SCHEREN SCISSORS TIJERAS CISEAUX FORBICI

Mikroschere
Micro Scissors
Micro Tijeras
Micro-ciseaux
Micro forbici



Fig. 1
Fig. 2
Fig. 3

NOYES

12,0 cm/4³/₄"



Fig. 1 AC 751/12
Fig. 2 AC 753/12
Fig. 3 AC 755/12



AC 760/11
AC 762/11
AC 764/11

WECKER

11,0 cm/4¹/₃"



AC 770/02



AC 770/03



AC 771/09



AC 772/09

CASTROVIEJO
AC 770/00
9,0 cm/3¹/₂"



AC 773/10
spitz
pointed
agudas
pointues
acute

CASTROVIEJO
10,0 cm/4"



AC 775/10
stumpf
blunt
romas
mousses
smusse

CASTROVIEJO
10,0 cm/4"

AA
AB
AC
AD
AE
AF
AK
AL
AO
AR
KA
KL
KU
PA
PB
PF
PI
PK
PL
PM
PP
PS
PT
PU
PV
KYE

Mikroscheren
 Micro Scissors
 Micro Tijeras
 Micro-ciseaux
 Micro forbici



WESTCOTT
 AC 780/11
 11,0 cm/4¹/₃"



WESTCOTT
 AC 782/11
 11,0 cm/4¹/₃"



WESTCOTT
 AC 797/01
 11,5 cm/4¹/₂"



WESTCOTT
 AC 797/02
 11,5 cm/4¹/₂"

nopa[®] TUC[®]

SC Super Cut

SUPER CUT TUC



SUPER CUT TUC

Verfügbare Modelle / Available Patterns

Im Katalog durch * markiert. / Marked in catalog with * .

AC	930/14	SC	METZENBAUM SCS.TUC STR.BL/BL	14,5 CM	SC
AC	931/14	SC	METZENBAUM SCS.TUC CVD.BL/BL	14,5 CM	SC
AC	940/18	SC	METZENBAUM SCS.TUC STR.BL/BL	18,0 CM	SC
AC	941/18	SC	METZENBAUM SCS.TUC CVD.BL/BL	18,0 CM	SC
AC	960/14	SC	METZENBAUM-DELIC. TUC STR.BL/BL	14,5 CM	SC
AC	961/14	SC	METZENBAUM-DELIC. TUC CVD.BL/BL	14,5 CM	SC
AC	970/18	SC	METZENBAUM-DELIC. SCS.TUC STR.BL/BL	18,0 CM	SC
AC	971/18	SC	METZENBAUM-DELIC. SCS.TUC CVD.BL/BL	18,0 CM	SC
AC	974/11	SC	STEVENS TENOTOM.SCS. TUC STR.SH/SH	11,5CM	SC
AC	975/11	SC	STEVENS TENOTOM.SCS. TUC CVD.SH/SH	11,5 CM	SC
AC	976/11	SC	STEVENS TENOTOM.SCS. TUC STR. BL/BL	11,5 CM	SC
AC	977/11	SC	TENOTOMY SCISSORS TUC CVD. BL/BL	11,5 CM	SC
AC	984/11	SC	IRIS SCS.TUC STR.SH/SH	11,5 CM	SC
AC	985/11	SC	IRIS SCS.TUC CVD.SH/SH	11,5 CM	SC

Besonderheit:

Nutzen Sie die Vorteile von Hartmetalleinsätzen.

nopa TUC Super Cut Scheren haben eine rasierklingscharfe Schneide, kombiniert mit einer mikrogezahnten Schneide.

>> Diese Scheren sind durch schwarz/goldene Ringe gekennzeichnet.

Features:

Use the advantages of Tungsten Carbide.

nopa TUC Super Cut scissors have a razor-like edge combined with one micro serrated blade.

>> Black/golden rings for easy identification.

Scheren mit Hartmetalleinlagen
 Scissors with Tungsten Carbide Inserts
 Tijeras con filos de carburo de tungsteno
 Ciseaux avec plaquettes en carbure de tungstène
 Forbici con taglio al carburo di tungsteno



AC 912/16

KELLY
 16,0 cm/6 1/4"

AC 913/16

SCHEREN SCISSORS TIJERAS CISEAUX FORBICI

Scheren mit Hartmetalleinlagen
 Scissors with Tungsten Carbide Inserts
 Tijeras con filos de carburo de tungsteno
 Ciseaux avec plaquettes en carbure de tungstène
 Forbici con taglio al carburo di tungsteno

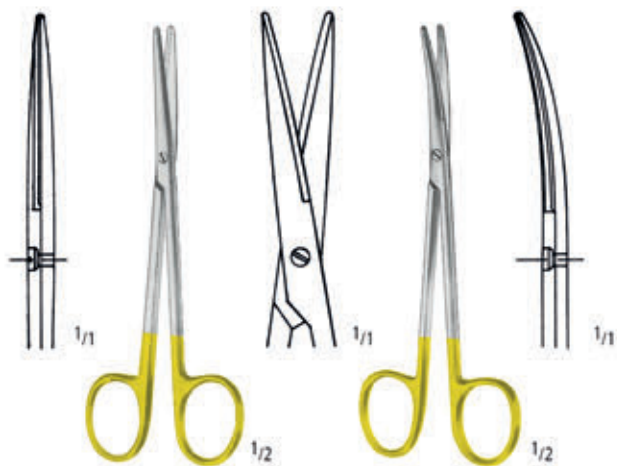

METZENBAUM

AC 922/11
 11,5 cm/4 1/2"

AC 923/11
 11,5 cm/4 1/2"



METZENBAUM

AC 930/14*
 14,5 cm/5 3/4"

AC 931/14*
 14,5 cm/5 3/4"

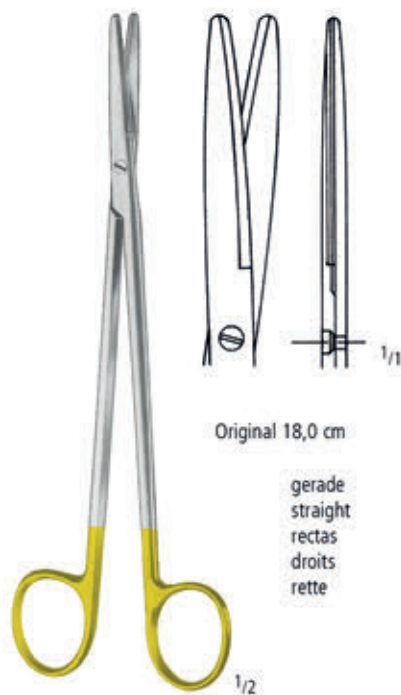

Original 18,0 cm

gerade
 straight
 rectas
 droits
 rette

METZENBAUM

AC 940/18*
 18,0 cm/7"

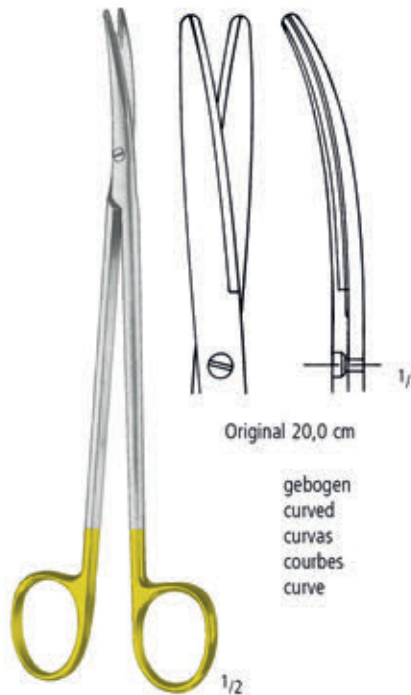

Original 20,0 cm

gebogen
 curved
 curvas
 courbes
 curve

METZENBAUM

AC 941/18*
 18,0 cm/7"

Scheren mit Hartmetalleinlagen
 Scissors with Tungsten Carbide Inserts
 Tijeras con fillos de carburo de tungsteno
 Ciseaux avec plaquettes en carbure de tungstène
 Forbici con taglio al carburo di tungsteno

METZENBAUM-DELICATE



AC 960/14*
 14,5 cm / 5³/₄"

AC 961/14*
 14,5 cm / 5³/₄"

METZENBAUM-DELICATE
 AC 962/14
 14,5 cm / 5³/₄"

AC 963/14
 14,5 cm / 5³/₄"



Original 18,0 cm

gerade
 straight
 rectas
 droits
 rette

METZENBAUM-DELICATE
 AC 970/18*
 18,0 cm / 7"



Original 20,0 cm

gebogen
 curved
 curvas
 courbes
 curve

METZENBAUM-DELICATE
 AC 971/18*
 18,0 cm / 7"

SCHEREN SCISSORS TIJERAS CISEAUX FORBICI

Scheren mit Hartmetalleinlagen
 Scissors with Tungsten Carbide Inserts
 Tijeras con filos de carburo de tungsteno
 Ciseaux avec plaquettes en carbure de tungstène
 Forbici con taglio al carburo di tungsteno

Original 11,5 cm

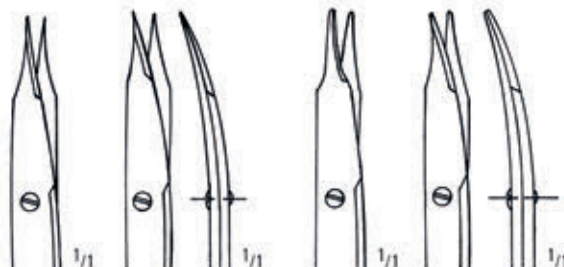

	spitz pointed agudas pointues acuta		stumpf blunt romas mousses smussa
gerade straight rectas droits rette	gebogen curved curvas courbes curve	gerade straight rectas droits rette	gebogen curved curvas courbes curve

STEVENS

10,5 cm/4¹/₄"
 11,5 cm/4¹/₂"

AC 974/10
 AC 974/11*

AC 975/10
 AC 975/11*

AC 976/10
 AC 976/11*

AC 977/10
 AC 977/11*

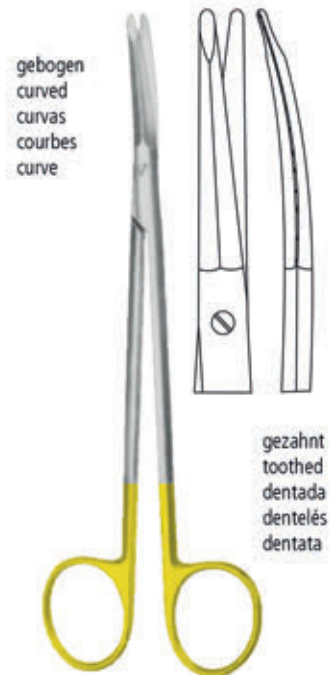

gebogen
curved
curvas
courbes
curve

gezahnt
toothed
dentada
dentelés
dentata

TOENNIS-ADSON-DELICATE

AC 977/17
 17,5 cm/7"

GOLDMAN-FOX

AC 980/13
 13,0 cm/5"

AC 981/13
 13,0 cm/5"

KAYE

AC 983/15
 15,0 cm/6"

* Auch erhältlich als SC * Also available as SC

AA AB AC AD AE AF AG AH AI AJ AK AL AM AN AO AP AQ AR AS AT AU AV AW AX AY AZ BA BB BC BD BE BF BG BH BI BJ BK BL BM BN BO BP BQ BR BS BT BU BV BW BX BY BZ CA CB CC CD CE CF CG CH CI CJ CK CL CM CN CO CP CQ CR CS CT CU CV CW CX CY CZ DA DB DC DE DF DG DH DI DJ DK DL DM DN DO DP DQ DR DS DT DU DV DW DX DY DZ EA EB EC ED EE EF EG EH EI EJ EK EL EM EN EO EP EQ ER ES ET EU EV EW EX EY EZ FA FB FC FD FE FF FG FH FI FJ FK FL FM FN FO FP FQ FR FS FT FU FV FW FX FY FZ GA GB GC GD GE GF GG GH GI GJ GK GL GM GN GO GP GQ GR GS GT GU GV GW GX GY GZ HA HB HC HD HE HF HG HH HI HJ HK HL HM HN HO HP HQ HR HS HT HU HV HW HX HY HZ IA IB IC ID IE IF IG IH II IJ IK IL IM IN IO IP IQ IR IS IT IU IV IW IX IY IZ JA JB JC JD JE JF JG JH JI JJ JK JL JM JN JO JP JQ JR JS JT JU JV JW JX JY JZ KA KB KC KD KE KF KG KH KI KJ KL KM KN KO KP KQ KR KS KT KU KV KW KX KY KZ LA LB LC LD LE LF LG LH LI LJ LK LL LM LN LO LP LQ LR LS LT LU LV LW LX LY LZ MA MB MC MD ME MF MG MH MI MJ MK ML MN MO MP MQ MR MS MT MU MV MW MX MY MZ NA NB NC ND NE NF NG NH NI NJ NK NL NO NP NQ NR NS NT NU NV NW NX NY NZ OA OB OC OD OE OF OG OH OI OJ OK OL OM ON OO OP OQ OR OS OT OU OV OW OX OY OZ PA PB PC PD PE PF PG PH PI PJ PK PL PM PN PO PP PQ PR PS PT PU PV PW PX PY PZ QA QB QC QD QE QF QG QH QI QJ QK QL QM QN QO QP QQ QR QS QT QU QV QW QX QY QZ RA RB RC RD RE RF RG RH RI RJ RK RL RM RN RO RP RQ RR RS RT RU RV RW RX RY RZ SA SB SC SD SE SF SG SH SI SJ SK SL SM SN SO SP SQ SR SS ST SU SV SW SX SY SZ TA TB TC TD TE TF TG TH TI TJ TK TL TM TN TO TP TQ TR TS TT TU TV TW TX TY TZ UA UB UC UD UE UF UG UH UI UJ UK UL UM UN UO UP UQ UR US UT UU UV UW UX UY UZ VA VB VC VD VE VF VG VH VI VJ VK VL VM VN VO VP VQ VR VS VT VU VW VX VY VZ WA WB WC WD WE WF WG WH WI WJ WK WL WM WN WO WP WQ WR WS WT WU WV WW WX WY WZ XA XB XC XD XE XF XG XH XI XJ XK XL XM XN XO XP XQ XR XS XT XU XV XW XX XY XZ YA YB YC YD YE YF YG YH YI YJ YK YL YM YN YO YP YQ YR YS YT YU YV YW YX YY YZ ZA ZB ZC ZD ZE ZF ZG ZH ZI ZJ ZK ZL ZM ZN ZO ZP ZQ ZR ZS ZT ZU ZV ZW ZX ZY ZZ

AC SCHEREN SCISSORS TIJERAS CISEAUX FORBICI

Scheren mit Hartmetalleinlagen
 Scissors with Tungsten Carbide Inserts
 Tijeras con filos de carburo de tungsteno
 Ciseaux avec plaquettes en carbure de tungstène
 Forbici con taglio al carburo di tungsteno



AC 984/11*
 11,5 cm/4 1/2"



AC 985/11*
 11,5 cm/4 1/2"

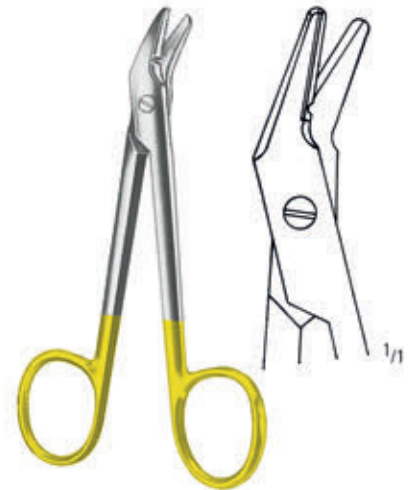

UNIVERSAL
 AC 987/12
 12,0 cm/4 3/4"

nopa
TUC[®]

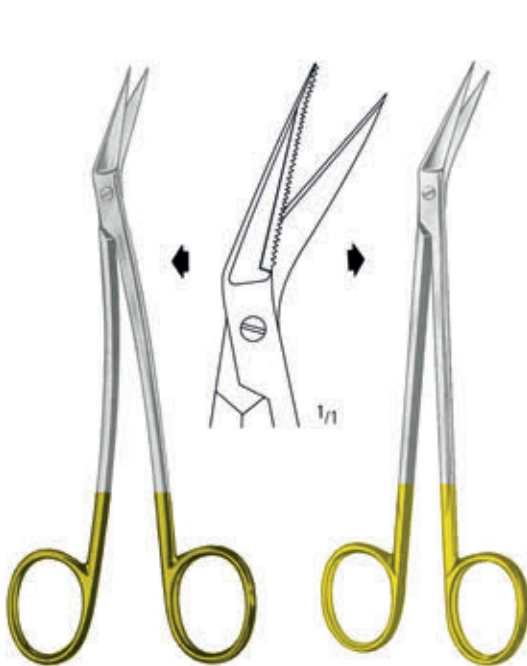

LOCKLIN
 AC 988/16
 16,5 cm/6 1/2"

LOCKLIN
 AC 989/16
 16,5 cm/6 1/2"

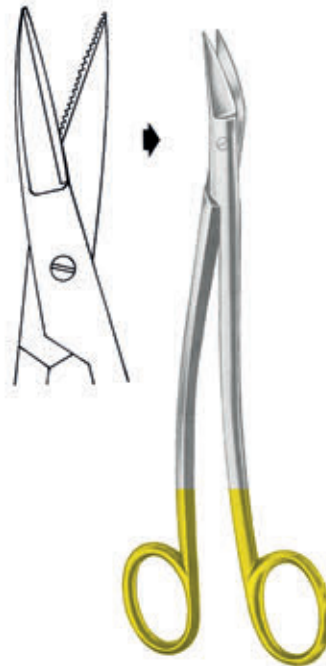

DEAN
 AC 990/17
 17,0 cm/6 3/4"



LISTER
 AC 999/18
 18,0 cm/7"

SKALPELLE
SCALPELS
BISTURIES
BISTOURIS
BISTURI

AD

nopa[®] instruments



SKALPELLE SCALPELS BISTURIES BISTOURIS BISTURI

Skalpellgriffe
 Scalpel Handles
 Mangos de bisturios
 Manches pour bistouris
 Manici per bisturi

für Skalpellklingen Größe 3
 for Scalpel Blades size 3
 para hojas de bisturios tamaño 3
 pour lames pour bistouris taille 3
 per lame per bisturi formato 3



AD 009/03
 No. 3



AD 010/03
 No. 3



AD 027/07
 No. 7K



AD 030/16



AD 031/16
 No. 3

AA
 AB
 AC
AD
 AE
 AF
 AK
 AL
 AO
 AR
 KA
 KL
 KU
 PA
 PB
 PF
 PI
 PK
 PL
 PM
 PP
 PS
 PT
 PU
 PV
 KYE

Skalpelli-griffe, Skalpelli-klingen
 Scalpel Handles, Scalpel Blades
 Mangos de bisturios, Hojas de bisturios
 Manches pour bistouris, Lames de bistouris
 Manici per bisturi, Lame per bisturi

MINI

Verpackungseinheit / packing unit = 10 St./pc.

steril
 sterile
 estériles
 stériles
 sterili



Fig. 61
AD 065/61

Fig. 62
AD 065/62

Fig. 62S
AD 065/63

Fig. 64
AD 065/64

Fig. 65
AD 065/65

Fig. 67
AD 065/67

Fig. 69
AD 065/69

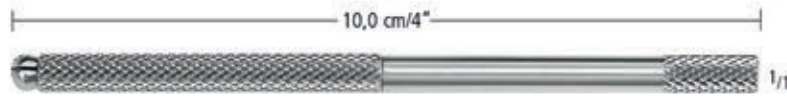

AD 065/10

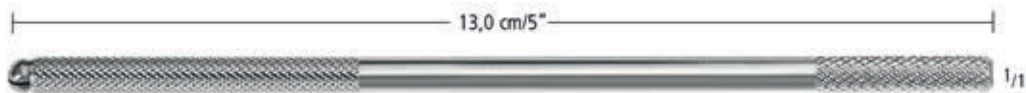

AD 065/13



AD 065/15

SKALPELLE SCALPELS BISTURIES BISTOURIS BISTURI

Skalpellinge
Scalpel Blades
Hojas de bisturias
Lames pour bistouris
Lame per bisturi

passend für die Griffe
for handles
para los mangos
pour les manches
per i manici

AD 009/03
AD 010/03
AD 027/07
AD 030/16
AD 031/16



Fig. 10
AD 075/10



Fig. 11
AD 075/11



Fig. 12d
AD 076/12



Fig. 15
AD 075/15



Fig. 15c
AD 076/15



steril
sterile
estériles
stériles
sterili

AA
AB
AC
AD
AE
AF
AG
AH
AI
AJ
AK
AL
AM
AN
AO
AP
AQ
AR
AS
AT
AU
AV
AW
AX
AY
AZ
BA
BB
BC
BD
BE
BF
BG
BH
BI
BJ
BK
BL
BM
BN
BO
BP
BQ
BR
BS
BT
BU
BV
BW
BX
BY
BZ
CA
CB
CC
CD
CE
CF
CG
CH
CI
CJ
CK
CL
CM
CN
CO
CP
CQ
CR
CS
CT
CU
CV
CW
CX
CY
KYE

Zahnfleischmesser
 Gum knives
 Bisturies para encias
 Couteaux à gencives
 Coltelli per gengive



AD 435/01
 No. 1



AD 435/02
 No. 2



AD 435/03
 No. 3

NAHT
SUTURE
SUTURA
SUTURE
SUTURA

AE

nopa[®] instruments



AE NAHT SUTURE SUTURA SUTURE SUTURA

Nadelhalter
Needle Holders
Porta-agujas
Porte-aiguilles
Portaghi



BOYNTON
AE 036/12
12,0 cm/4³/₄"

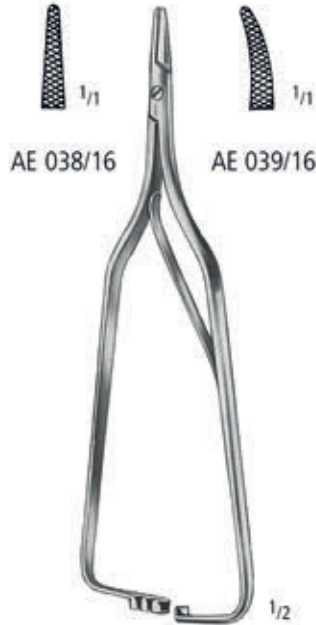

ARRUGA
16,0 cm/6¹/₄"



DERF
AE 050/12
12,0 cm/4³/₄"



DERF-CONVERSE
AE 052/12
12,5 cm/5"



COLLIER
AE 056/12
12,5 cm/5"



DOYEN
AE 058/12
12,5 cm/5"

NAHT SUTURE SUTURA SUTURE SUTURA

Nadelhalter
Needle Holders
Porta-agujas
Porte-aiguilles
Portaghi

AA
AB
AC
AD
AE
AF
AK
AL
AO
AR
KA
KL
KU
PA
PB
PF
PI
PK
PL
PM
PP
PS
PT
PU
PV
KYE

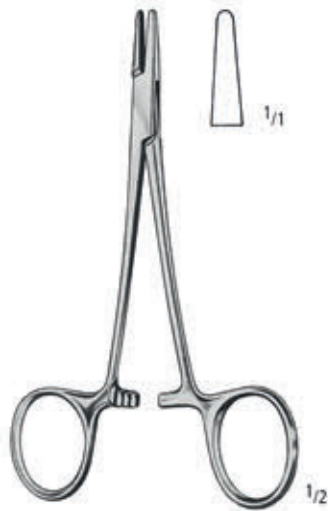

WEBSTER
AE 060/13
13,0 cm/5"

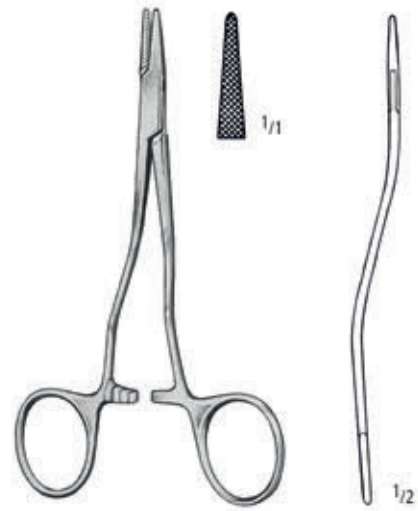

KILNER
AE 063/13
13,0 cm/5"



HALSEY
13,0 cm/5"



NEIVERT
AE 068/13
13,0 cm/5"

AE NAHT SUTURE SUTURA SUTURE SUTURA

Nadelhalter
Needle Holders
Porta-agujas
Porte-aiguilles
Portaghi



CRILE-WOOD
15,0 cm/6" AE 070/15
18,0 cm/7" AE 070/18



BABY-CRILE-WOOD
AE 072/15
15,0 cm/6"



CARROLL
AE 074/15
15,0 cm/6"



MAYO-HEGAR



AE 100/14
14,0 cm/5 1/2"



AE 100/16
16,0 cm/6 1/4"



AE 100/18
18,0 cm/7"



AE 100/20
20,0 cm/8"

MAYO-HEGAR-DELICATE



AE 110/16
16,0 cm/6 1/4"



AE 110/18
18,0 cm/7"



AE 110/20
20,0 cm/8"

NAHT SUTURE SUTURA SUTURE SUTURA

Nadelhalter
Needle Holders
Porta-agujas
Porte-aiguilles
Portaghi

AA
AB
AC
AD
AE
AF
AK
AL
AO
AR
KA
KL
KU
PA
PB
PF
PI
PK
PL
PM
PP
PS
PT
PU
PV
KYE

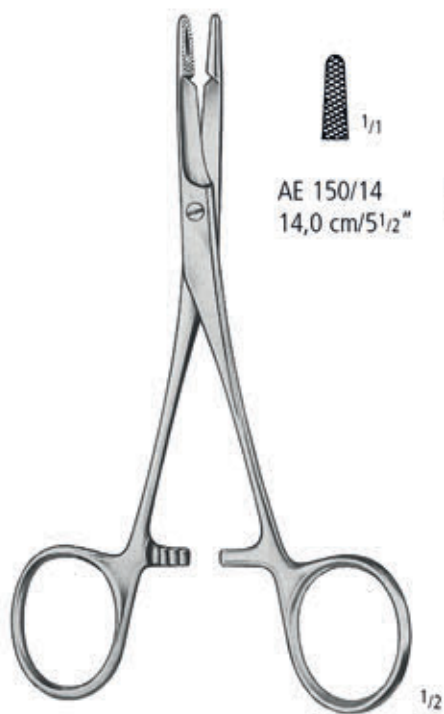

OLSEN-HEGAR

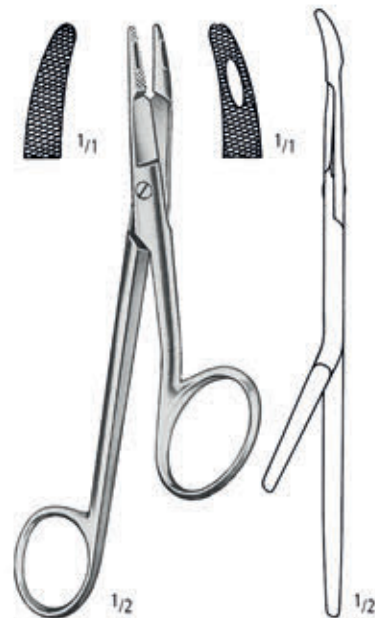

GILLIES
AE 155/16
16,0 cm/6 1/4"



MATHIEU

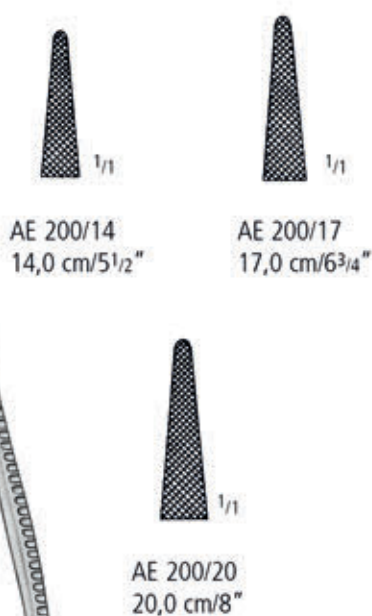

MATHIEU-DELICATE



MATHIEU



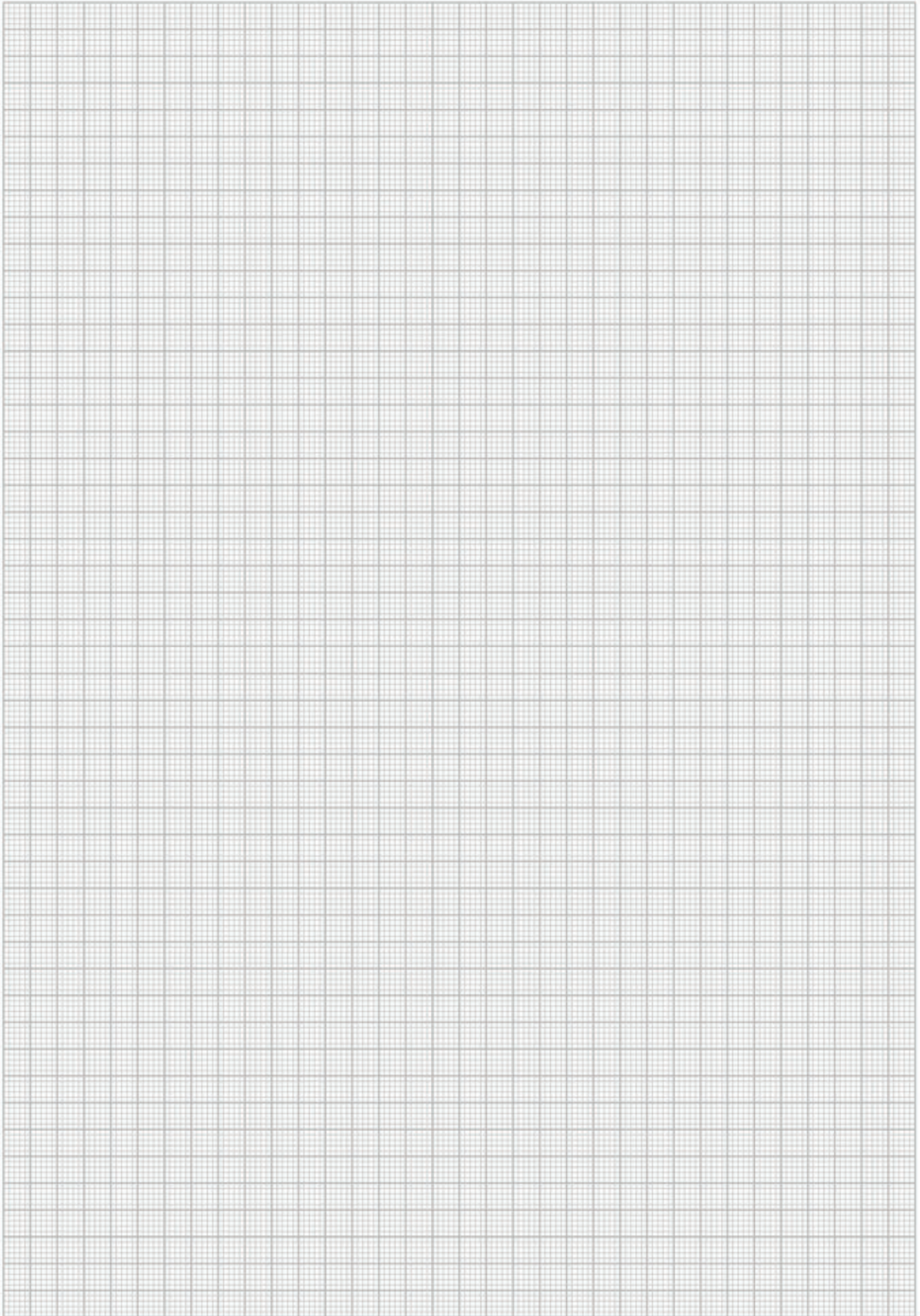

NAHT SUTURE SUTURA SUTURE SUTURA

Nadelhalter
Needle Holders
Porta-agujas
Porte-aiguilles
Portaghi

AA
AB
AC
AD
AE
AF
AK
AL
AO
AR
KA
KL
KU
PA
PB
PF
PI
PK
PL
PM
PP
PS
PT
PU
PV
KYE



TOENNIS
AE 226/18
18,0 cm/7"



LANGENBECK

AE 228/16
16,0 cm/6 1/4"

AE 228/18
18,0 cm/7"

AE 228/20
20,0 cm/8"

AE NAHT SUTURE SUTURA SUTURE SUTURA

Hartmetalleinsatzplättchen mit Pyramidenprofil
 Tungsten Carbide Tips with pyramidal profile
 Bocas de carburo de tungsteno con perfil de estructura piramidal
 Plaquettes en carbure de tungstène avec profil pyramidal
 Placche di carburo di tungsteno con profilo in forma piramidale

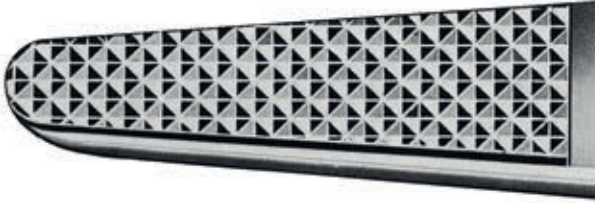

Teilung:	0,5 mm	Für Nahtmaterial 3/0 und größer
Serration:	0,5 mm	For suture sizes 3/0 and larger
Graduación:	0,5 mm	Para sutura 3/0 y más grande
Graduation:	0,5 mm	Pour suture 3/0 et plus grand
Graduazione:	0,5 mm	Per sutura 3/0 e più grande

"STANDARD"

(Mayo-Hegar, Mathieu, etc.)

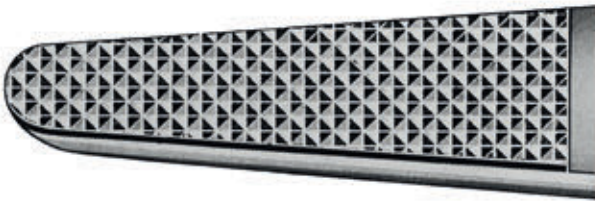

Teilung:	0,4 mm	Für Nahtmaterial zwischen 3/0 und 6/0
Serration:	0,4 mm	For sutures sizes between 3/0 and 6/0
Graduación:	0,4 mm	Para suturas entre 3/0 y 0/6
Graduation:	0,4 mm	Pour sutures entre 3/0 et 0/6
Graduazione:	0,4 mm	Per sutura tra 3/0 e 0/6

"FINE"

(Crile-Wood, Halsey, etc.)



Teilung:	0,2 mm	Für Nahtmaterial zwischen 7/0 und 10/0
Serration:	0,2 mm	For sutures sizes between 7/0 and 10/0
Graduación:	0,2 mm	Para suturas entre 7/0 y 10/0
Graduation:	0,2 mm	Pour sutures entre 7/0 et 10/0
Graduazione:	0,2 mm	Per sutura tra 7/0 e 10/0

"MICRO"

(Castroviejo)



glatt	Für extrem feines Nahtmaterial
smooth	For the smallest suture sizes available
lisa	Para suturas extremamente finas
lisses	Pour matériel de suture extrêmement fin
liscio	Per materiale di sutura finissima

"SMOOTH"

(Webster, Halsey, Reill, Castroviejo, Jacobson, etc.)

NAHT SUTURE SUTURA SUTURE SUTURA

Nadelhalter mit Hartmetalleinsätzen
 Needle Holders with Tungsten Carbide Inserts
 Porta-agujas con bocas de carburo de Tungsteno
 Porte-aiguilles à mors en carbure de tungstène
 Portaghi con placche di carburo di tungsteno



MAYO-HEGAR

AE 400/14
 14,0 cm/5½"



AE 400/16
 16,0 cm/6¼"



AE 400/18
 18,0 cm/7"



AE 400/20
 20,0 cm/8"

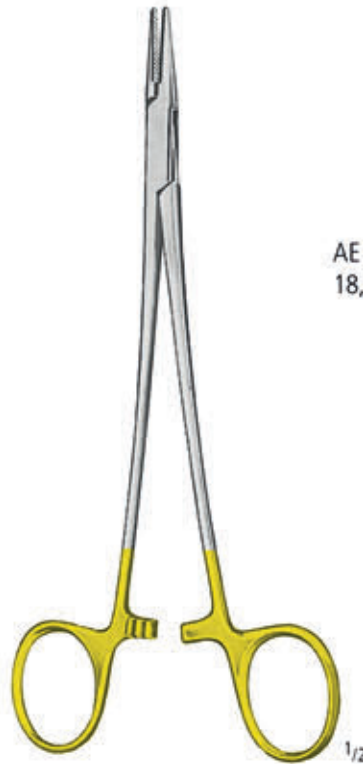

**DE BAKEY
 (MAYO-HEGAR-DELICATE)**

AE 420/18
 18,0 cm/7"



AE 420/20
 20,0 cm/8"



AA
 AB
 AC
 AD
AE
 AF
 AK
 AL
 AO
 AR
 KA
 KL
 KU
 PA
 PB
 PF
 PI
 PK
 PL
 PM
 PP
 PS
 PT
 PU
 PV
 KYE

AE NAHT SUTURE SUTURA SUTURE SUTURA

Nadelhalter mit Hartmetalleinsätzen
 Needle Holders with Tungsten Carbide Inserts
 Porta-agujas con bocas de carburo de Tungsteno
 Porte-aiguilles à mors en carbure de tungstène
 Portaghi con placche di carburo di tungsteno



DERF
 AE 450/12
 12,5 cm/5"



CONVERSE
 AE 452/12
 12,5 cm/5"



KILNER
 AE 455/13
 13,5 cm/5 1/4"



NEIVERT
 AE 456/13
 13,0 cm/5"

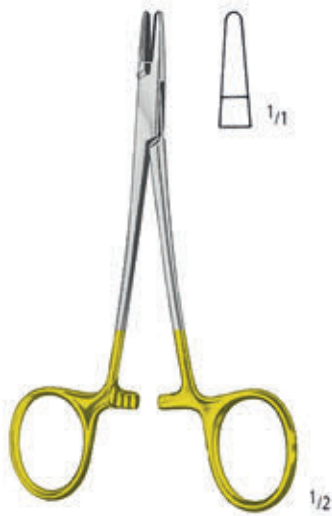

WEBSTER
 AE 460/13
 13,0 cm/5"



HALSEY
 13,0 cm/5"

NAHT SUTURE SUTURA SUTURE SUTURA

Nadelhalter mit Hartmetalleinsätzen
 Needle Holders with Tungsten Carbide Inserts
 Porta-agujas con bocas de carburo de Tungsteno
 Porte-aiguilles à mors en carbure de tungstène
 Portaghi con placche di carburo di tungsteno



BABY-CRILE-WOOD
 AE 468/15
 15,0 cm/6"



CRILE-WOOD
 AE 469/15
 15,0 cm/6"

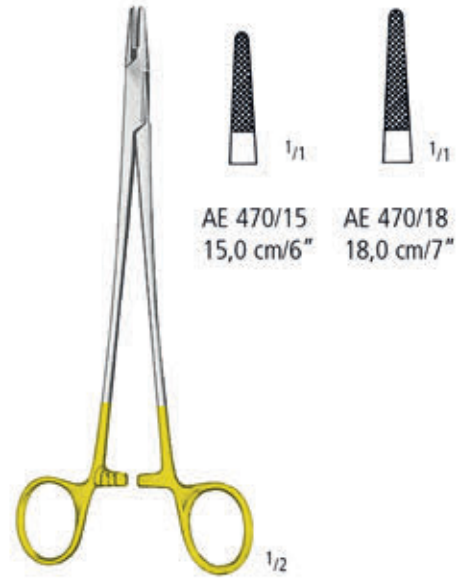

AE 470/15
 15,0 cm/6" AE 470/18
 18,0 cm/7"

CRILE-WOOD



OLSEN-HEGAR

AE 488/14
 14,0 cm/5 1/2" AE 488/17
 17,0 cm/6 3/4"



OLSEN-HEGAR-USA
 AE 489/16
 16,0 cm/6 1/4"

AA
 AB
 AC
 AD
AE
 AF
 AK
 AL
 AO
 AR
 KA
 KL
 KU
 PA
 PB
 PF
 PI
 PK
 PL
 PM
 PP
 PS
 PT
 PU
 PV
 KYE

AE NAHT SUTURE SUTURA SUTURE SUTURA

Nadelhalter mit Hartmetalleinsätzen
 Needle Holders with Tungsten Carbide Inserts
 Porta-agujas con bocas de carburo de Tungsteno
 Porte-aiguilles à mors en carbure de tungstène
 Portaghi con placche di carburo di tungsteno

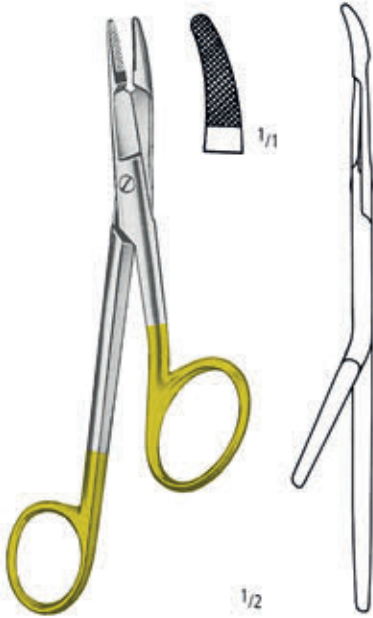

GILLIES
 AE 490/16
 16,0 cm/6¹/₄"



AE 500/14
 14,0 cm/5¹/₂"



AE 500/17
 17,0 cm/6³/₄"



AE 500/20
 20,0 cm/8"



MATHIEU
 AE 501/14
 14,0 cm/5¹/₂"



AE 502/17
 17,0 cm/6³/₄"



AE 502/20
 20,0 cm/8"

MATHIEU



AE 504/14
 14,0 cm/5¹/₂"



AE 504/17
 17,0 cm/6³/₄"



AE 504/20
 20,0 cm/8"

MATHIEU-DELICATE

NAHT SUTURE SUTURA SUTURE SUTURA

Nadelhalter mit Hartmetalleinsätzen
 Needle Holders with Tungsten Carbide Inserts
 Porta-agujas con bocas de carburo de Tungsteno
 Porte-aiguilles à mors en carbure de tungstène
 Portaghi con placche di carburo di tungsteno



METZENBAUM



AE 507/17
17,0 cm/6³/₄"



AE 507/19
19,5 cm/7³/₄"



AE 514/12



BOYNTON
12,0 cm/4³/₄"



AE 515/12

nopa
TUC®



AE 516/16



ARRUGA
16,0 cm/6¹/₄"



AE 517/16



TOENNIS
AE 522/18
18,0 cm/7"



LICHTENBERG
AE 524/20
20,0 cm/8"

AA
AB
AC
AD
AE
AF
AK
AL
AO
AR
KA
KL
KU
PA
PB
PF
PI
PK
PL
PM
PP
PS
PT
PU
PV
KYE

AE NAHT SUTURE SUTURA SUTURE SUTURA

Nadelhalter mit Hartmetalleinsätzen
 Needle Holders with Tungsten Carbide Inserts
 Porta-agujas con bocas de carburo de Tungsteno
 Porte-aiguilles à mors en carbure de tungstène
 Portaghi con placche di carburo di tungsteno



AE 540/16 16,0 cm/6 1/4"	AE 540/18 18,0 cm/7"	AE 540/20 20,0 cm/8"	LANGENBECK
AE 542/18 18,0 cm/7"	AE 542/20 20,0 cm/8"	AE 542/23 23,0 cm/9"	LANGENBECK-DELICATE
AE 544/18 18,0 cm/7"	AE 544/20 20,0 cm/8"	AE 544/23 23,0 cm/9"	LANGENBECK-RYDER

NAHT SUTURE SUTURA SUTURE SUTURA

Drahtzangen mit Hartmetalleinsätzen
 Wire Twisting Forceps with Tungsten Carbide Inserts
 Pinzas para torcer hilos con bocas de carburo de Tungsteno
 Pincès à torsader le fil à mors en carbure de tungstène
 Pinze per ritorcere fili con placche di carburo di tungsteno

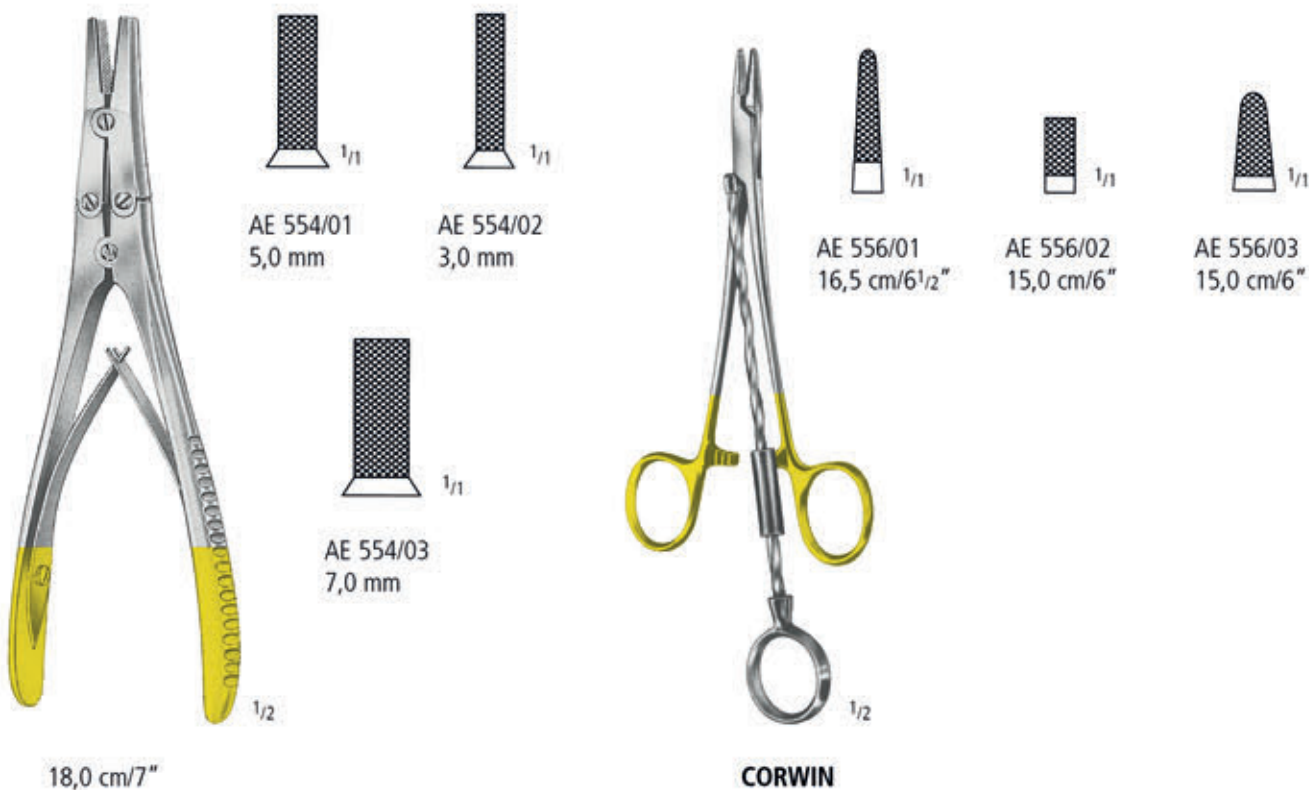
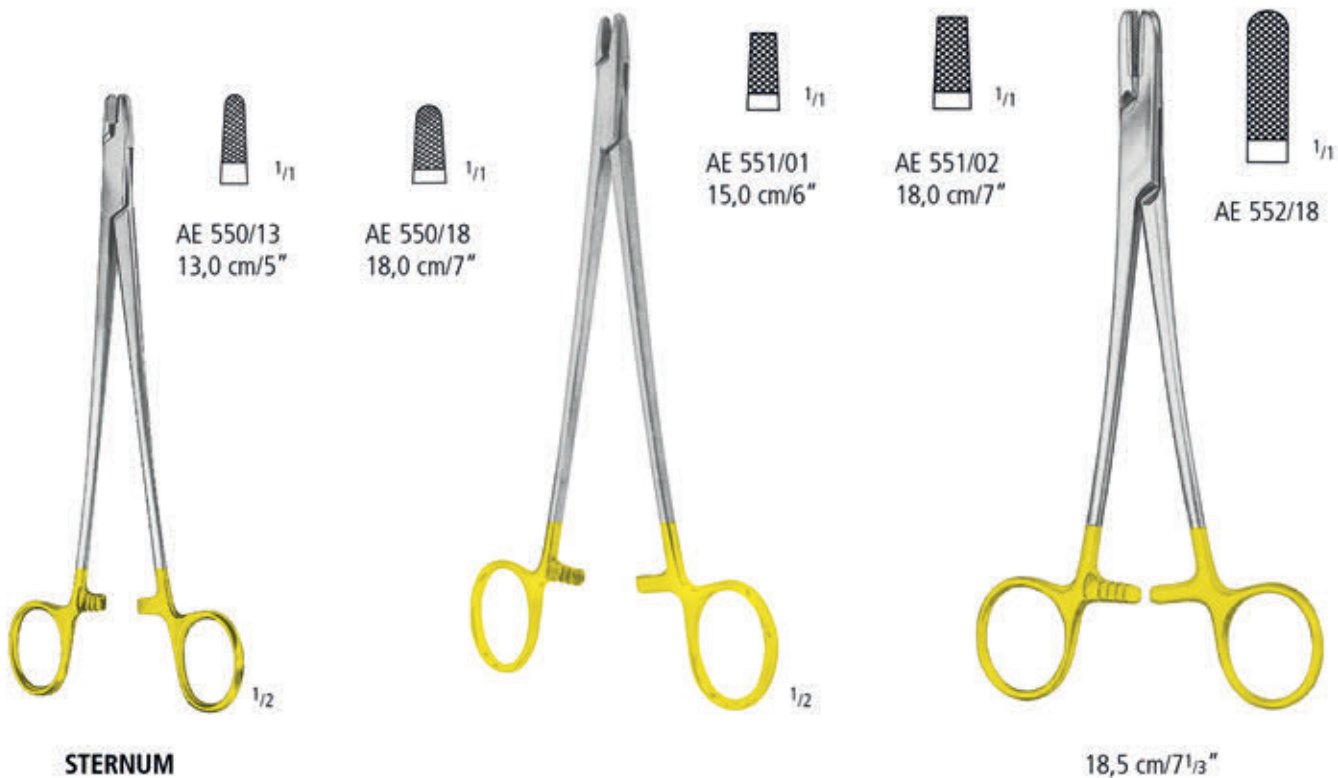

AA
AB
AC
AD
AE
AF
AK
AL
AO
AR
KA
KL
KU
PA
PB
PF
PI
PK
PL
PM
PP
PS
PT
PU
PV
KYE

AE NAHT SUTURE SUTURA SUTURE SUTURA

Mikro-Nadelhalter mit Hartmetalleinsätzen
 Micro-Needle Holders with Tungsten Carbide Inserts
 Micro-Porta-agujas con bocas de carburo de Tungsteno
 Micro-Porte-aiguilles à mors en carbure de tungstène
 Micro-Portaghi con placche di carburo di tungsteno

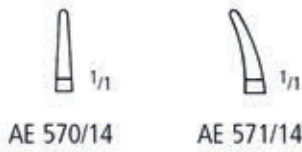

CASTROVIEJO
 14,0 cm/5 1/2"

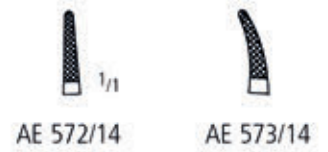

CASTROVIEJO
 14,0 cm/5 1/2"

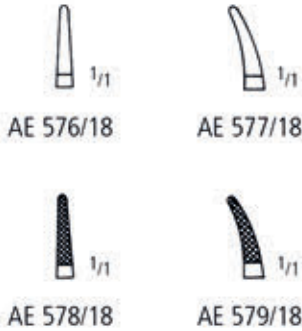

18,0 cm/7"

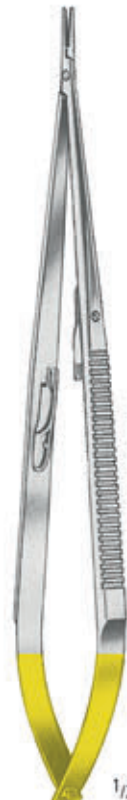

JACOBSON
 21,0 cm/8 1/4"

NAHT SUTURE SUTURA SUTURE SUTURA

Mikro-Nadelhalter mit Rundgriff
 Micro-Needle Holders with Pen-Type Handle
 Micro-Porta-agujas con mango redondo
 Micro-Porte-aiguilles à manches rondes
 Micro-Portaghi con manici rotondi

AA
 AB
 AC
 AD
 AE
 AF
 AK
 AL
 AO
 AR
 KA
 KL
 KU
 PA
 PB
 PF
 PI
 PK
 PL
 PM
 PP
 PS
 PT
 PU
 PV
 KYE



 1/1
 AE 610/15

 1/1
 AE 611/15

REILL
 15,0 cm/6"



 1/1
 AE 612/15

 1/1
 AE 613/15

REILL
 15,0 cm/6"

Mikro-Nadelhalter mit Rundgriff
 Micro-Needle Holders with Pen-Type Handle
 Micro-Porta-agujas con mango redondo
 Micro-Porte-aiguilles à manches rondes
 Micro-Portaghi con manici rotondi



18,0 cm/7"



18,0 cm/7"

NAHT SUTURE SUTURA SUTURE SUTURA

Mikro-Nadelhalter
Micro-Needle Holders
Micro-Porta-agujas
Micro-Porte-aiguilles
Micro-Portaghi

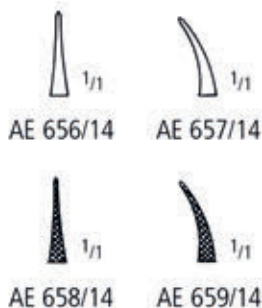

CASTROVIEJO
14,0 cm/5 1/2"

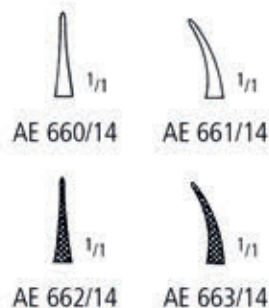

CASTROVIEJO
14,0 cm/5 1/2"



breiter Griff
wide handle
mango ancho
manche large
manico largo

CASTROVIEJO
14,0 cm/5 1/2"

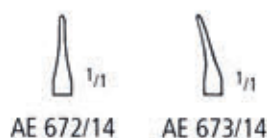

CASTROVIEJO
14,0 cm/5 1/2"



JACOBSON

AA
AB
AC
AD
AE
AF
AK
AL
AO
AR
KA
KL
KU
PA
PB
PF
PI
PK
PL
PM
PP
PS
PT
PU
PV
KYE

TUPFERZANGEN
SPONGE FORCEPS
PINZAS PARA POLIPOS
PINCES A PANSEMENTS
PINZE PER POLIPI

AF

nopa[®] instruments



Schwammzangen, Korn- und Tupferzangen
 Sponge Holding Forceps, Polypus and Dressing Forceps
 Pinzas para esponjas, pinzas para pólipos
 Pincas à éponges, pincas à pansements
 Pinze per spugne, pinze per polipi



AF 050/16

LISTER

- 13,0 cm/5" AF 050/13
- 16,0 cm/6¹/₄" AF 050/16
- 18,0 cm/7" AF 050/18



GROSS-MAIER

- AF 100/20
- AF 100/22

- 20,0 cm/8"
- 22,0 cm/8³/₄"

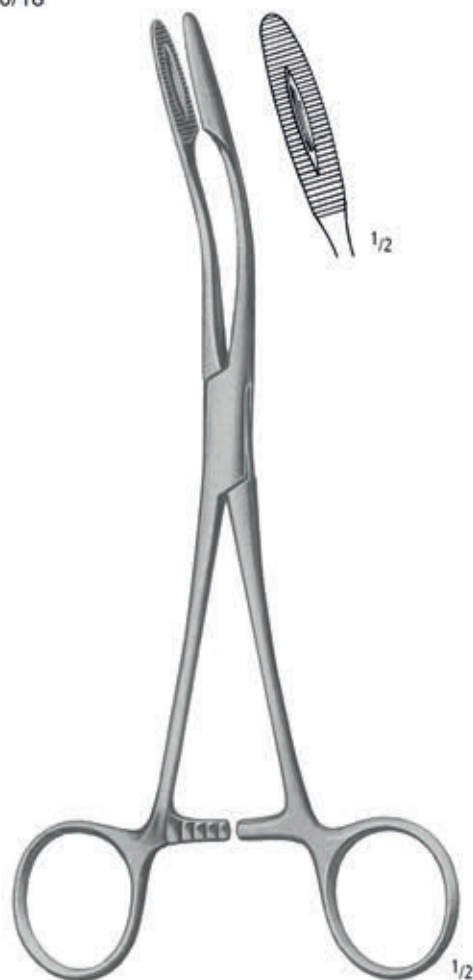

GROSS-MAIER

- AF 101/20
- AF 101/22

Korn- und Tupferzangen
 Polypus and Dressing Forceps
 Pinzas para pólipos
 Pincas à pansements
 Pinze per polipi



AF 226/17

WALTON
 17,0 cm/6³/₄"



AF 227/17

WUNDHAKEN
RETRACTORS
SEPARADORES
ECARTEURS
DIVARICATORI

AK

nopa[®] instruments



AK WUNDHAKEN RETRACTORS SEPARADORES ECARTEURS DIVARICATORI

Feine Wundhaken
Delicate Hooks
Ganchos
Crochets très fins
Divaricatori sottili

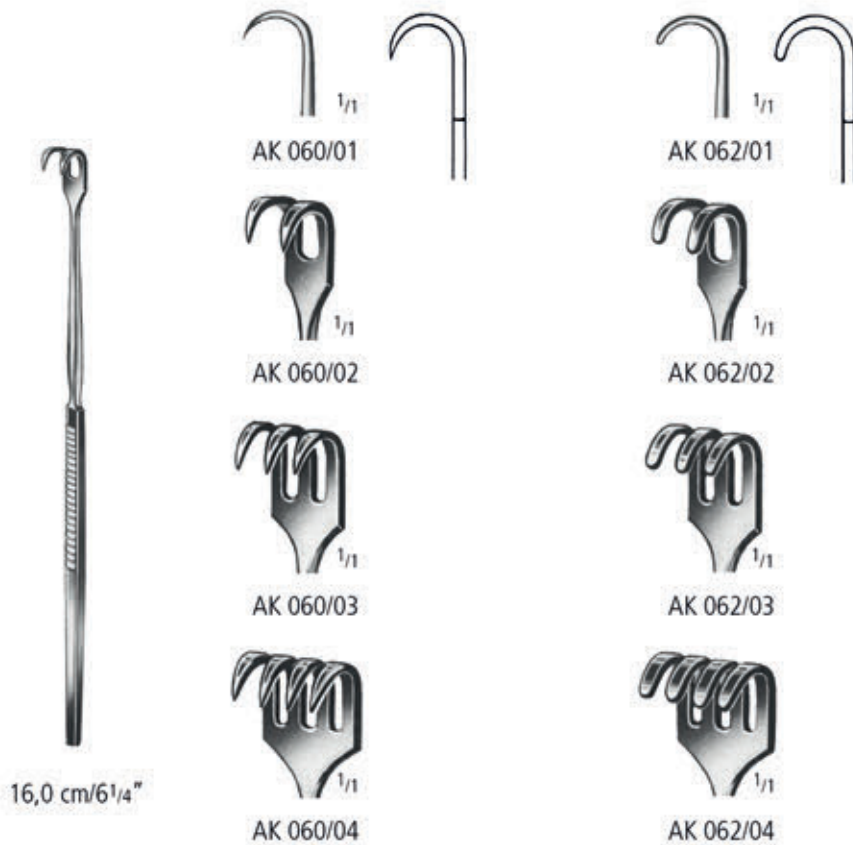
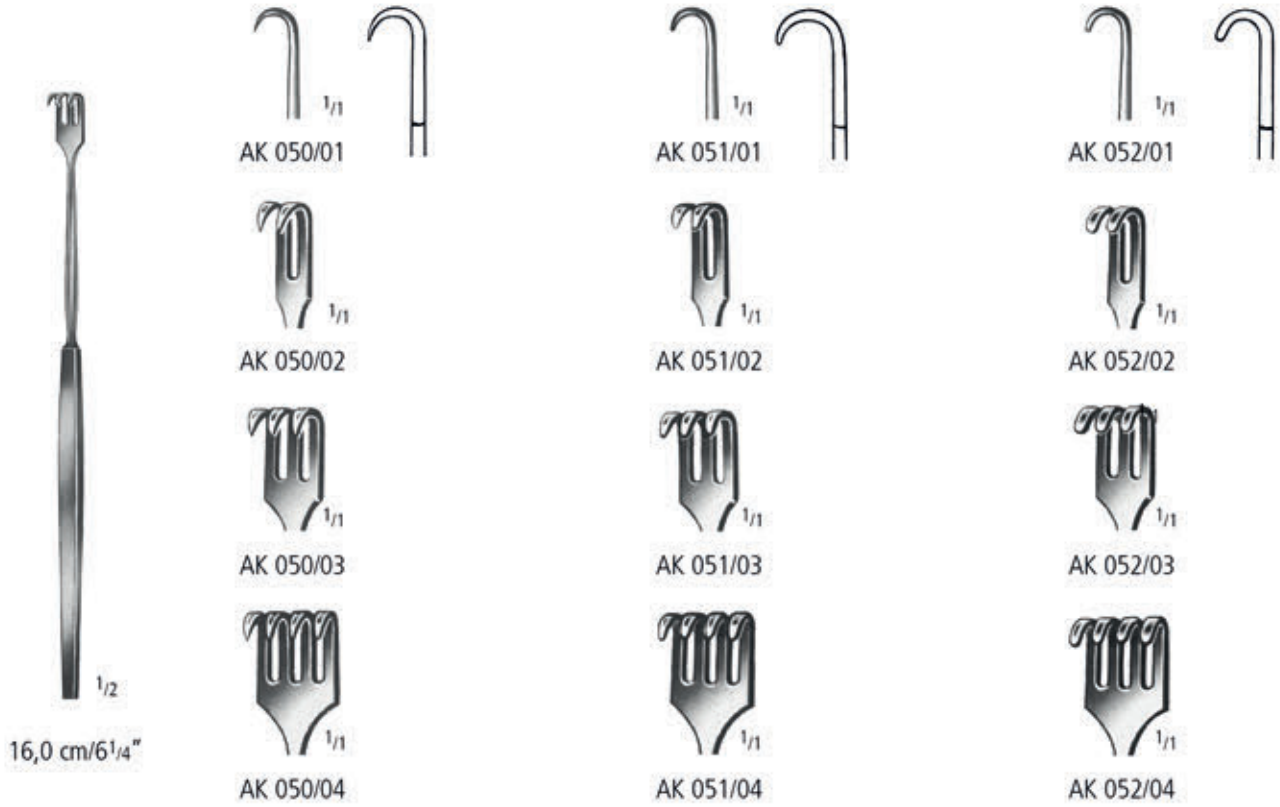

WUNDHAKEN RETRACTORS SEPARADORES ECARTEURS DIVARICATORI

Feine Wundhaken
Delicate Hooks
Ganchos
Crochets très fins
Divaricatori sottili

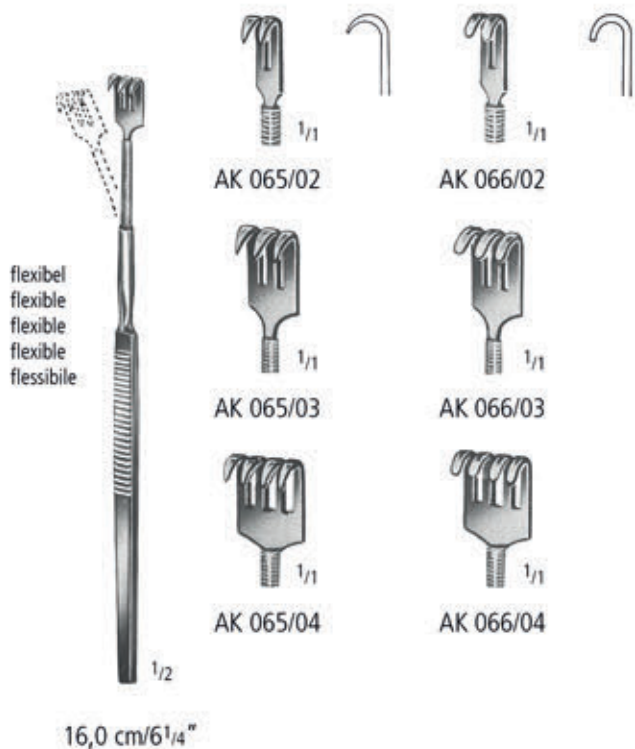

16,0 cm/6 1/4"

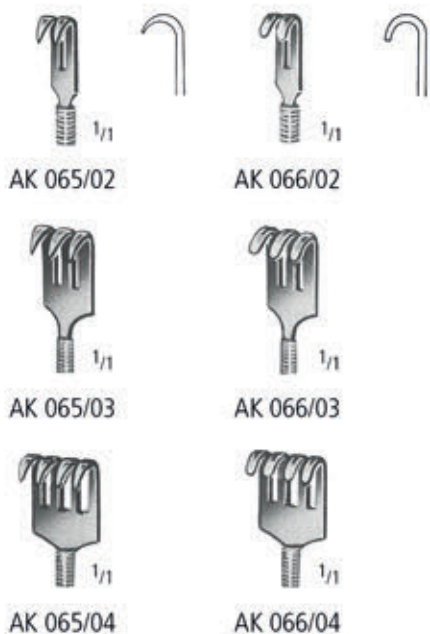

JOSEPH

AK 070/16
16,0 cm/6 1/4"

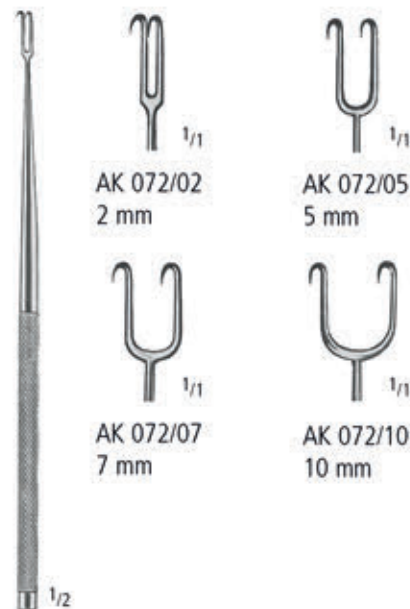

JOSEPH

16,0 cm/6 1/4"

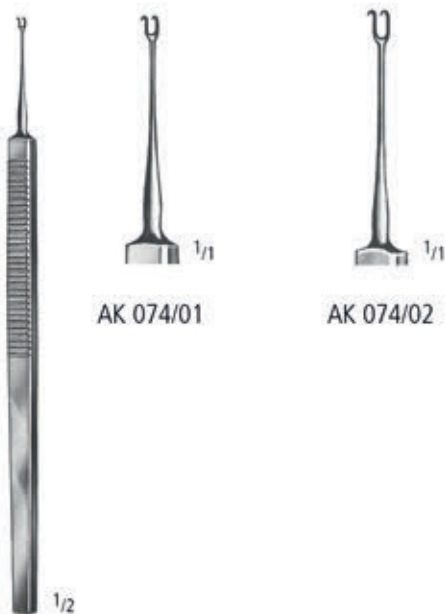

GUTHRIE

16,0 cm/6 1/4"



ROLLET

AK 076/13
13,0 cm/5"

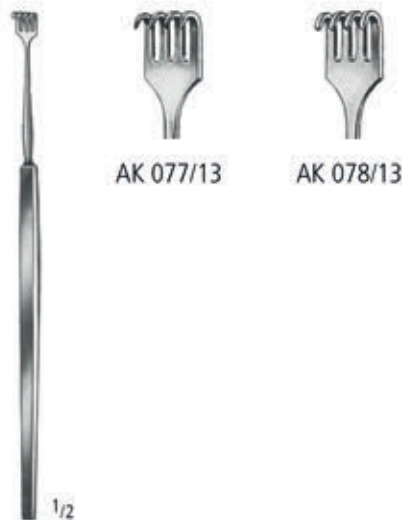

KNAPP

13,0 cm/5"

AA
AB
AC
AD
AE
AF
AK
AL
AO
AR
KA
KL
KU
PA
PB
PF
PI
PK
PL
PM
PP
PS
PT
PU
PV
KYE

AK WUNDHAKEN RETRACTORS SEPARADORES ECARTEURS DIVARICATORI

Feine Wundhaken
Delicate Hooks
Ganchos
Crochets très fins
Divaricatori sottili



MEYERDING
18,0 cm/7"

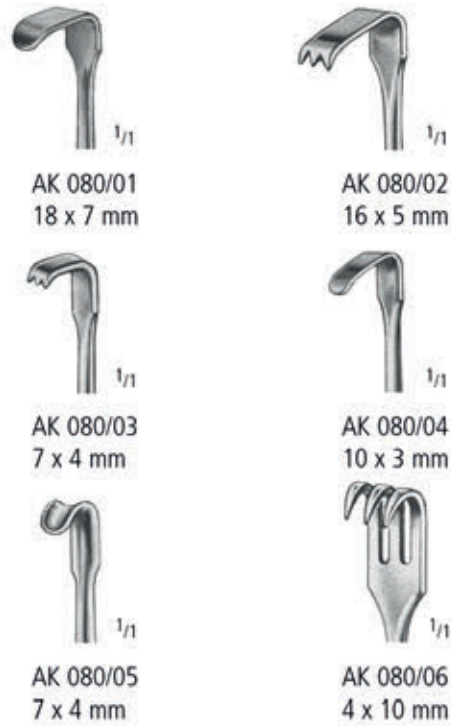

SENN-GREEN
15,0 cm/6"



MINI-LANGENBECK
16,0 cm/6 1/4"

WUNDHAKEN RETRACTORS SEPARADORES ECARTEURS DIVARICATORI

Feine Wundhaken
Delicate Hooks
Ganchos
Crochets très fins
Divaricatori sottili



DESMARRES
13,0 cm/5"

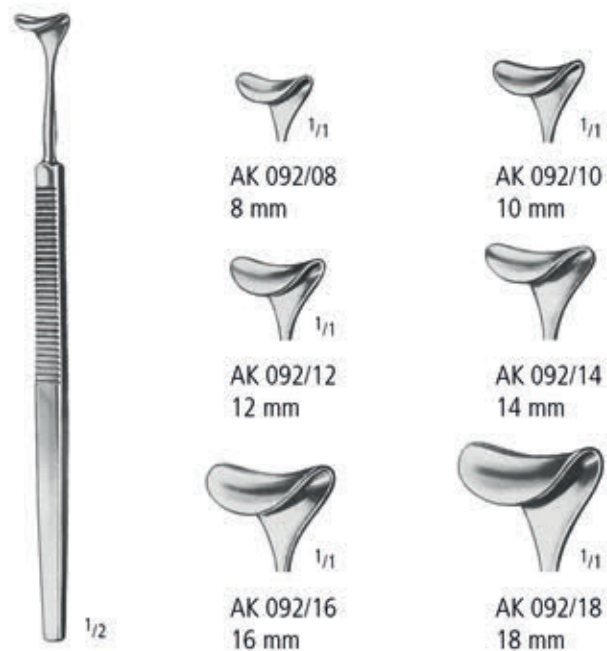

DESMARRES
16,0 cm/6 1/4"

AA
AB
AC
AD
AE
AF
AK
AL
AO
AR
KA
KL
KU
PA
PB
PF
PI
PK
PL
PM
PP
PS
PT
PU
PV
KYE

Weichteilhaken
Soft tissue retractors
Separadores para partes blandas
Ecarteurs pour parties molles
Divaricatori per tessuti molli



OBWEGESER
24,0 cm/9 1/2"



AK 222/01
10 x 35 mm



AK 222/02
10 x 42 mm



AK 222/03
12 x 55 mm



AK 222/04
14 x 70 mm



AK 222/05
16 x 80 mm

WUNDHAKEN RETRACTORS SEPARADORES ECARTEURS DIVARICATORI

Weichteilhaken
Soft tissue retractors
Separadores para partes blandas
Ecarteurs pour parties molles
Divaricatori per tessuti molli



OBWEGESER
24,0 cm/9 1/2"



AK 223/01
5 x 16 mm



AK 223/02
7 x 25 mm



AK 223/03
10 x 35 mm



AK 223/04
10 x 42 mm



AK 223/05
12 x 55 mm



AK 223/06
14 x 70 mm



AK 223/07
16 x 80 mm

AA
AB
AC
AD
AE
AF
AK
AL
AO
AR
KA
KL
KU
PA
PB
PF
PI
PK
PL
PM
PP
PS
PT
PU
PV
KYE

Ramushaken
Ramus retractors
Separadores para el ramo
Ecarteurs pour ramus
Separatore per ramo

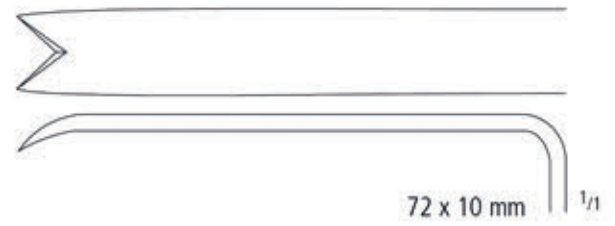
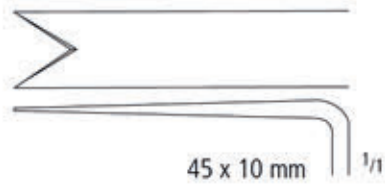

OBWEGESER
AK 225/01
22,0 cm/8³/₄"



OBWEGESER
AK 225/02
24,0 cm/9¹/₂"



LANGENBECK
AK 230/01-05
22,0 cm/8³/₄"



AK 230/01
AK 231/01
30 x 11 mm



AK 230/02
AK 231/02
30 x 14 mm



AK 230/03
AK 231/03
30 x 16 mm



AK 230/04
AK 231/04
40 x 11 mm



AK 230/05
AK 231/05
50 x 11 mm



LANGENBECK
AK 231/01-05
22,0 cm/8³/₄"



1/2

KOCHER-LANGENBECK
21,5 cm/8 1/2"



1/1

AK 233/01
25 x 6 mm



1/1

AK 233/02
35 x 8 mm



1/1

AK 233/03
35 x 11 mm



1/1

AK 233/04
35 x 15 mm



1/1

AK 233/05
40 x 11 mm



1/1

AK 233/06
55 x 11 mm



1/1

AK 233/07
70 x 14 mm



1/1

AK 233/08
80 x 12 mm



1/1

AK 233/09
80 x 16 mm

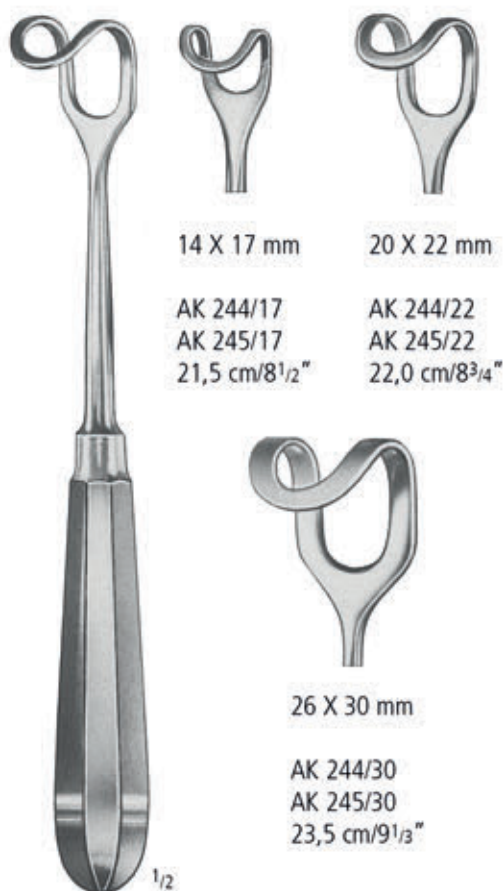

14 X 17 mm

AK 244/17
AK 245/17
21,5 cm/8¹/₂"

20 X 22 mm

AK 244/22
AK 245/22
22,0 cm/8³/₄"

26 X 30 mm

AK 244/30
AK 245/30
23,5 cm/9¹/₃"

MIDDELDORPF
AK 244/17-30



MIDDELDORPF
AK 245/17-30

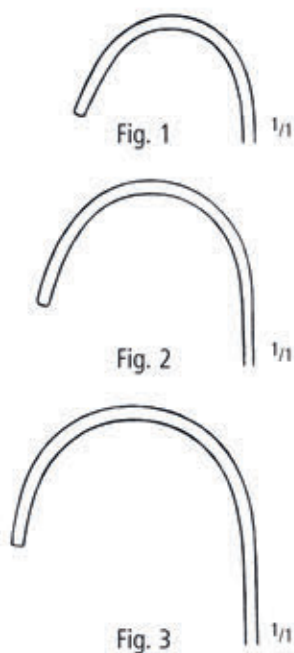

ROUX
16,5 cm/6¹/₂"
Fig. 1+2+3 AK 350/00
Fig. 1 AK 350/01
Fig. 2 AK 350/02
Fig. 3 AK 350/03



Fig. 1 AK 352/01
Fig. 2 AK 352/02

FARABEUF
AK 352/00 Fig. 1+2
12,0 cm/4³/₄"



Fig. 1 AK 354/01
Fig. 2 AK 354/02

FARABEUF
AK 354/00 Fig. 1+2
15,0 cm/6"



Fig. 1 AK 373/01
Fig. 2 AK 373/02

PARKER
AK 373/00 Fig. 1+2
13,5 cm/5¹/₄"

SONDEN, TROKARE, SAUGROHRE
PROBES, TROCARS, SUCTION TUBES
SONDAS, TROCARES,
TUBOS DE ASPIRACION
SONDES, TROCARTS,
CANULES D'ASPIRATION
SONDE, TREQUARTI,
CANNULE PER ASPIRAZIONE

AL + AO

nopa[®] instruments



Sonden
Probes
Sondas
Sondes
Sonde



Silber
silver
de plata
en argent
d'argento



	1,0 mm	2,0 mm
11,5 cm/4 1/2"	AL 001/11	AL 002/11
13,0 cm/5"	AL 001/13	AL 002/13
14,5 cm/5 3/4"	AL 001/14	AL 002/14
16,0 cm/6 1/4"	AL 001/16	AL 002/16
18,0 cm/7"	AL 001/18	AL 002/18
20,0 cm/8"	AL 001/20	AL 002/20
25,0 cm/10"	AL 001/25	AL 002/25

AL 003/11
AL 003/13
AL 003/14
AL 003/16
AL 003/18
AL 003/20
AL 003/25

MYRTLE LEAF

AL 007/14
AL 007/16
AL 007/18
AL 007/20

STACKE

AL 013/10
10,5 cm/4 1/4"
Ø 1,0 mm



11,5 cm/4 1/2"	AL 015/11
13,0 cm/5"	AL 015/13
14,5 cm/5 3/4"	AL 015/14
16,0 cm/6 1/4"	AL 015/16
18,0 cm/7"	AL 015/18
20,0 cm/8"	AL 015/20

DOYEN

AL 017/14

AL 020/11
AL 020/13
AL 020/14
AL 020/16
AL 020/18

NELATON

AL 022/16

AA
AB
AC
AD
AE
AF
AK
AL
AO
AR
KA
KL
KU
PA
PB
PF
PI
PK
PL
PM
PP
PS
PT
PU
PV
KYE

Sonden und Watteträger
 Probes and Cotton Applicators
 Sondas y Porta-algodones
 Sondes et Porte-coton
 Sonde e Portacotone

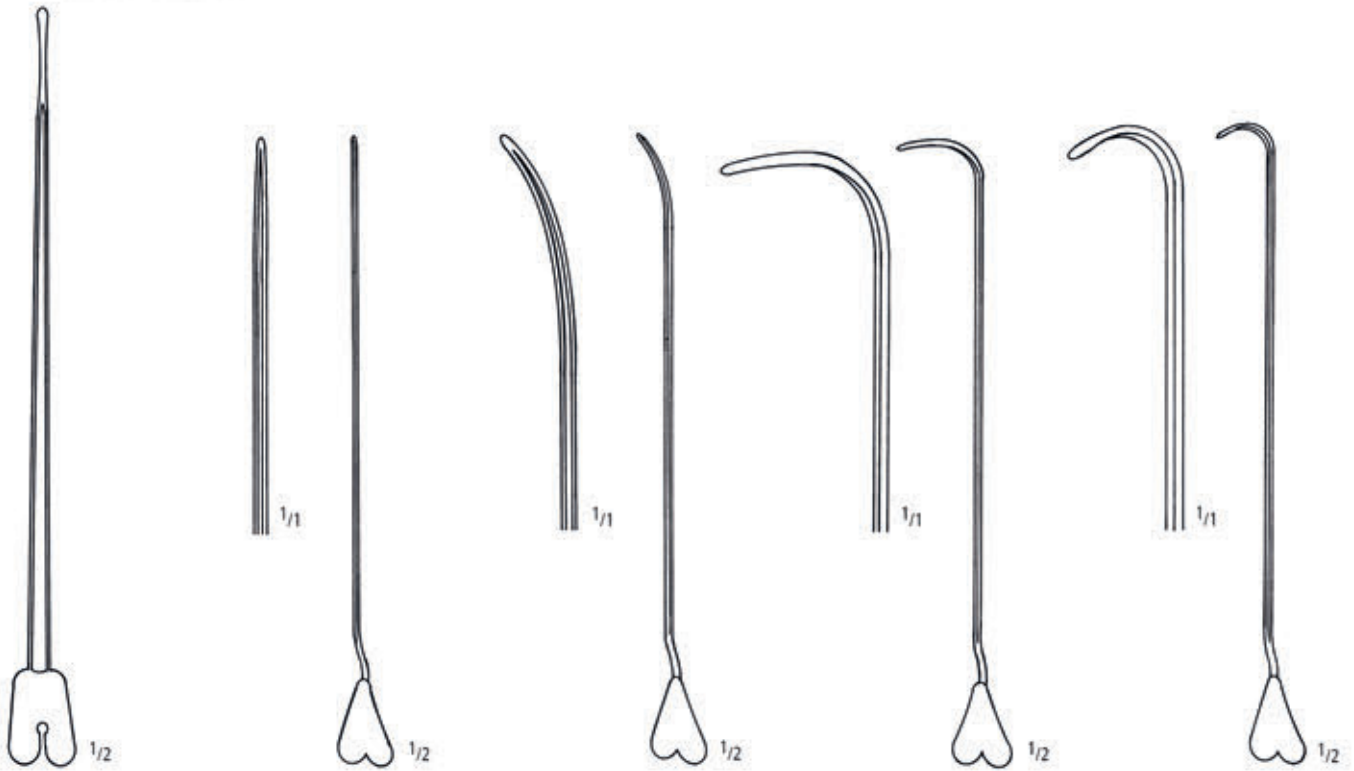

BRODIE

AL 026/20
 20,0 cm/8"

LOCKHART-MUMMERY

Fig. 1
 AL 030/01

Fig. 2
 AL 030/02

LOCKHART-MUMMERY

Fig. 3
 AL 030/03

Fig. 4
 AL 030/04

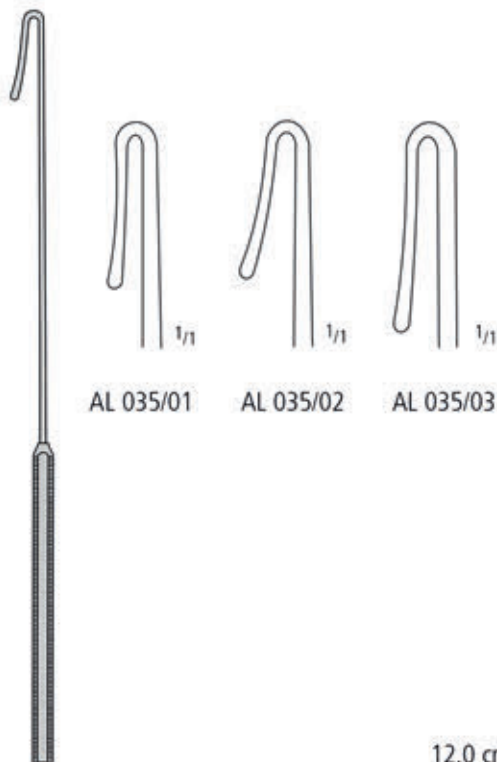

PRATT

21,0 cm/8¹/₄"

12,0 cm/4³/₄"
 14,0 cm/5¹/₂"
 16,5 cm/6¹/₂"
 18,0 cm/7"

FARRELL

0,9 mm
 AL 100/12
 AL 100/14

1,1 mm
 AL 100/16

1,2 mm
 AL 100/18

FARRELL

0,9 mm
 AL 120/12
 AL 120/14

1,1 mm
 AL 120/16

1,2 mm
 AL 120/18

Trokare
Trocars
Trocars
Trocarts
Trequarti

AA
AB
AC
AD
AE
AF
AK
AL
AO
AR
KA
KL
KU
PA
PB
PF
PI
PK
PL
PM
PP
PS
PT
PU
PV
KYE



LICHTWITZ
AO 180/00
1,8 mm



LICHTWITZ
AO 182/00
1,6 mm



DOUGLAS
AO 185/00
3,0 mm



PIERCE
AO 190/30
AO 190/40
AO 190/50

Ø 3,0 mm
Ø 4,0 mm
Ø 5,0 mm
Ø 5,5 mm



KRAUSE
AO 194/30
AO 194/40
AO 194/50
AO 194/55

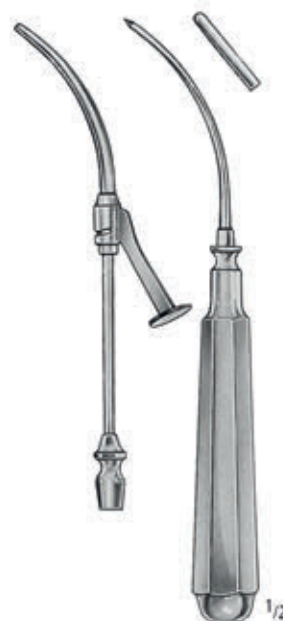

COAKLEY
AO 200/16
2,25 mm

Saugrohre
Suction Tubes
Tubos de aspiración
Canules d'aspiration
Cannule per aspirazione



COUPLAND
AO 410/00



BYRD
1,5 mm AO 412/15
2,5 mm AO 412/25
3,5 mm AO 412/35



FRAZIER
6 Charr. AO 430/06
8 Charr. AO 430/08
10 Charr. AO 430/10
12 Charr. AO 430/12

Saugrohre
Suction Tubes
Tubos de aspiración
Canules d'aspiration
Cannule per aspirazione

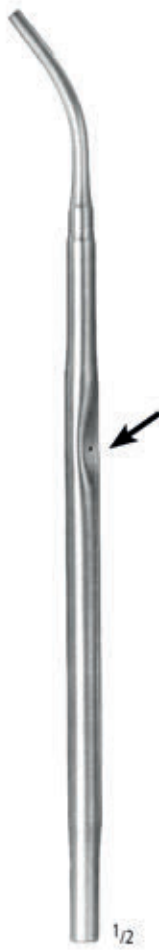

COGSWELL
AO 460/20
24,5 cm/9³/₄"
2,0 mm Ø



LUER
L = 110 mm



AO 461/30
Ø 3,0 mm



AO 461/35
Ø 3,5 mm

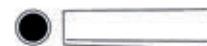

AO 461/45
Ø 4,5 mm

AA
AB
AC
AD
AE
AF
AG
AH
AI
AJ
AK
AL
AM
AN
AO
AP
AQ
AR
AS
AT
AU
AV
AW
AX
AY
AZ
BA
BB
BC
BD
BE
BF
BG
BH
BI
BJ
BK
BL
BM
BN
BO
BP
BQ
BR
BS
BT
BU
BV
BW
BX
BY
BZ
CA
CB
CC
CD
CE
CF
CG
CH
CI
CJ
CK
CL
CM
CN
CO
CP
CQ
CR
CS
CT
CU
CV
CW
CX
CY
CZ
DA
DB
DC
DD
DE
DF
DG
DH
DI
DJ
DK
DL
DM
DN
DO
DP
DQ
DR
DS
DT
DU
DV
DW
DX
DY
DZ
EA
EB
EC
ED
EE
EF
EG
EH
EI
EJ
EK
EL
EM
EN
EO
EP
EQ
ER
ES
ET
EU
EV
EW
EX
EY
EZ
FA
FB
FC
FD
FE
FF
FG
FH
FI
FJ
FK
FL
FM
FN
FO
FP
FQ
FR
FS
FT
FU
FV
FW
FX
FY
FZ
GA
GB
GC
GD
GE
GF
GG
GH
GI
GJ
GK
GL
GM
GN
GO
GP
GQ
GR
GS
GT
GU
GV
GW
GX
GY
GZ
HA
HB
HC
HD
HE
HF
HG
HH
HI
HJ
HK
HL
HM
HN
HO
HP
HQ
HR
HS
HT
HU
HV
HW
HX
HY
HZ
IA
IB
IC
ID
IE
IF
IG
IH
II
IJ
IK
IL
IM
IN
IO
IP
IQ
IR
IS
IT
IU
IV
IW
IX
IY
IZ
JA
JB
JC
JD
JE
JF
JG
JH
JI
JJ
JK
JL
JM
JN
JO
JP
JQ
JR
JS
JT
JU
JV
JW
JX
JY
JZ
KA
KB
KC
KD
KE
KF
KG
KH
KI
KJ
KK
KL
KM
KN
KO
KP
KQ
KR
KS
KT
KU
KV
KW
KX
KY
KZ
LA
LB
LC
LD
LE
LF
LG
LH
LI
LJ
LK
LL
LM
LN
LO
LP
LQ
LR
LS
LT
LU
LV
LW
LX
LY
LZ
MA
MB
MC
MD
ME
MF
MG
MH
MI
MJ
MK
ML
MM
MN
MO
MP
MQ
MR
MS
MT
MU
MV
MW
MX
MY
MZ
NA
NB
NC
ND
NE
NF
NG
NH
NI
NJ
NK
NL
NM
NN
NO
NP
NQ
NR
NS
NT
NU
NV
NW
NX
NY
NZ
OA
OB
OC
OD
OE
OF
OG
OH
OI
OJ
OK
OL
OM
ON
OO
OP
OQ
OR
OS
OT
OU
OV
OW
OX
OY
OZ
PA
PB
PC
PD
PE
PF
PG
PH
PI
PJ
PK
PL
PM
PN
PO
PP
PQ
PR
PS
PT
PU
PV
PW
PX
PY
PZ
QA
QB
QC
QD
QE
QF
QG
QH
QI
QJ
QK
QL
QM
QN
QO
QP
QQ
QR
QS
QT
QU
QV
QW
QX
QY
QZ
RA
RB
RC
RD
RE
RF
RG
RH
RI
RJ
RK
RL
RM
RN
RO
RP
RQ
RR
RS
RT
RU
RV
RW
RX
RY
RZ
SA
SB
SC
SD
SE
SF
SG
SH
SI
SJ
SK
SL
SM
SN
SO
SP
SQ
SR
SS
ST
SU
SV
SW
SX
SY
SZ
TA
TB
TC
TD
TE
TF
TG
TH
TI
TJ
TK
TL
TM
TN
TO
TP
TQ
TR
TS
TT
TU
TV
TW
TX
TY
TZ
UA
UB
UC
UD
UE
UF
UG
UH
UI
UJ
UK
UL
UM
UN
UO
UP
UQ
UR
US
UT
UU
UV
UW
UX
UY
UZ
VA
VB
VC
VD
VE
VF
VG
VH
VI
VJ
VK
VL
VM
VN
VO
VP
VQ
VR
VS
VT
VU
VV
VW
VX
VY
VZ
WA
WB
WC
WD
WE
WF
WG
WH
WI
WJ
WK
WL
WM
WN
WO
WP
WQ
WR
WS
WT
WU
WV
WW
WX
WY
WZ
XA
XB
XC
XD
XE
XF
XG
XH
XI
XJ
XK
XL
XM
XN
XO
XP
XQ
XR
XS
XT
XU
XV
XW
XX
XY
XZ
YA
YB
YC
YD
YE
YF
YG
YH
YI
YJ
YK
YL
YM
YN
YO
YP
YQ
YR
YS
YT
YU
YV
YW
YX
YY
YZ
ZA
ZB
ZC
ZD
ZE
ZF
ZG
ZH
ZI
ZJ
ZK
ZL
ZM
ZN
ZO
ZP
ZQ
ZR
ZS
ZT
ZU
ZV
ZW
ZX
ZY
ZZ

Saugrohre
Suction Tubes
Tubos de aspiración
Canules d'aspiration
Cannule per aspirazione



Länge/length	A=Ø 3,0 mm	A=Ø 4,0 mm	A=Ø 6,0 mm
14,0 cm	AO 463/03	AO 463/04	AO 463/06
18,0 cm	AO 464/03	AO 464/04	AO 464/06

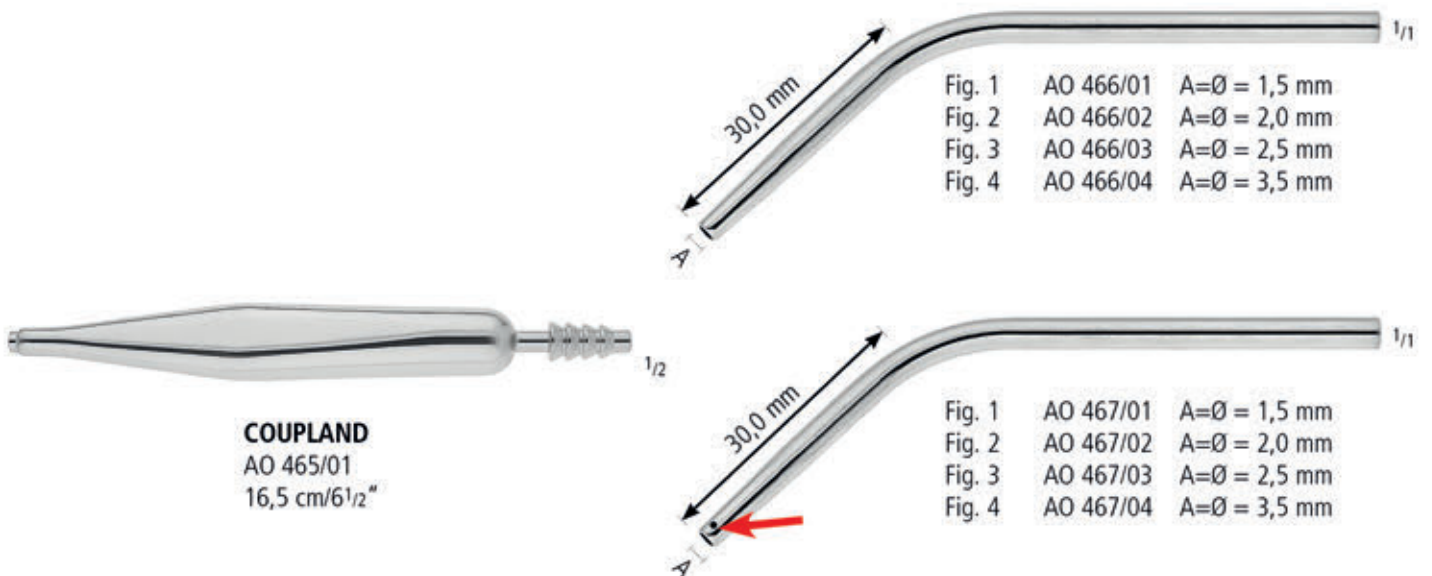

COUPLAND
AO 465/01
16,5 cm/6 1/2"

Ampullenspritzen
Cartridge Syringes
Jeringas para cartucho ampollas
Seringues à ampoule
Siringhe fiali



mit Aspiration
with aspiration
con aspiración
avec aspiration
con aspirazione

AO 861/18
1,8 ml



ohne Aspiration
without aspiration
sin aspiración
sans aspiration
senza aspirazione

AO 862/18
1,8 ml

stainless



mit Aspiration
with aspiration
con aspiración
avec aspiration
con aspirazione

AO 865/18
1,8 ml



AO 866/18
1,8 ml

AA
AB
AC
AD
AE
AF
AK
AL
AO
AR
KA
KL
KU
PA
PB
PF
PI
PK
PL
PM
PP
PS
PT
PU
PV
KYE

MESSINSTRUMENTE
MEASURING INSTRUMENTS
INSTRUMENTOS PARA MEDIDAS
INSTRUMENTS POUR MESURER
STRUMENTI PER MISURARE

AR

nopa[®] instruments





15,0 cm/6" AR 250/15
20,0 cm/8" AR 250/20



AR 251/01
0-80 mm

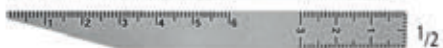

AR 251/02
0-60 mm

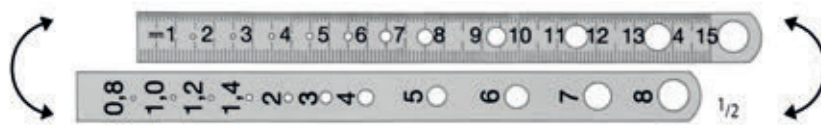

AR 255/15
150 mm

Messbereich und Lochlehre
measuring range and hole gauge
alcance de medición y calibre de agujeros
pour mesurer et calibre avec trous
per misurare fino e calibre forato

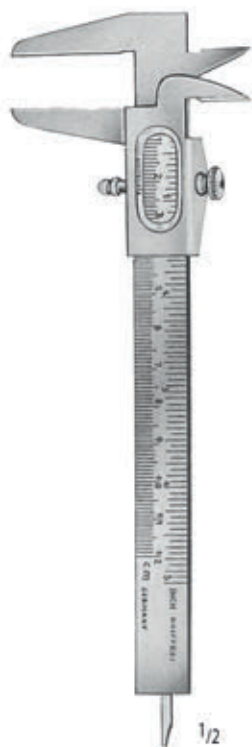

VERNIER
AR 260/12
0 - 120 mm



AR 260/18
0 - 200 mm / 0 - 8 inch



JAMESON
AR 261/08
0-80 mm / 0-3 inch



TOWNLEY
AR 262/12
0-80 mm



AR 263/11
0-100 mm



AR 263/12
0-80 mm



AR 263/13
0-80 mm



VERNIER
AR 265/20
0-200 mm



BOLEY
AR 264/11
0-100 mm



BOLEY
AR 264/12
0-100 mm

AA AB AC AD AE AF AG AH AI AJ AK AL AM AN AO AP AQ AR AS AT AU AV AW AX AY AZ BA BB BC BD BE BF BG BH BI BJ BK BL BM BN BO BP BQ BR BS BT BU BV BW BX BY BZ CA CB CC CD CE CF CG CH CI CJ CK CL CM CN CO CP CQ CR CS CT CU CV CW CX CY CZ DA DB DC DD DE DF DG DH DI DJ DK DL DM DN DO DP DQ DR DS DT DU DV DW DX DY DZ EA EB EC ED EE EF EG EH EI EJ EK EL EM EN EO EP EQ ER ES ET EU EV EW EX EY EZ FA FB FC FD FE FF FG FH FI FJ FK FL FM FN FO FP FQ FR FS FT FU FV FW FX FY FZ GA GB GC GD GE GF GG GH GI GJ GK GL GM GN GO GP GQ GR GS GT GU GV GW GX GY GZ HA HB HC HD HE HF HG HH HI HJ HK HL HM HN HO HP HQ HR HS HT HU HV HW HX HY HZ IA IB IC ID IE IF IG IH II IJ IK IL IM IN IO IP IQ IR IS IT IU IV IW IX IY IZ JA JB JC JD JE JF JG JH JI JJ JK JL JM JN JO JP JQ JR JS JT JU JV JW JX JY JZ KA KB KC KD KE KF KG KH KI KJ KL KM KN KO KP KQ KR KS KT KU KV KW KX KY KZ LA LB LC LD LE LF LG LH LI LJ LK LL LM LN LO LP LQ LR LS LT LU LV LW LX LY LZ MA MB MC MD ME MF MG MH MI MJ MK ML MN MO MP MQ MR MS MT MU MV MW MX MY MZ NA NB NC ND NE NF NG NH NI NJ NK NL NM NO NP NQ NR NS NT NU NV NW NX NY NZ OA OB OC OD OE OF OG OH OI OJ OK OL OM ON OO OP OQ OR OS OT OU OV OW OX OY OZ PA PB PC PD PE PF PG PH PI PJ PK PL PM PN PO PP PQ PR PS PT PU PV PW PX PY PZ QA QB QC QD QE QF QG QH QI QJ QK QL QM QN QO QP QQ QR QS QT QU QV QW QX QY QZ RA RB RC RD RE RF RG RH RI RJ RK RL RM RN RO RP RQ RR RS RT RU RV RW RX RY RZ SA SB SC SD SE SF SG SH SI SJ SK SL SM SN SO SP SQ SR SS ST SU SV SW SX SY SZ TA TB TC TD TE TF TG TH TI TJ TK TL TM TN TO TP TQ TR TS TT TU TV TW TX TY TZ UA UB UC UD UE UF UG UH UI UJ UK UL UM UN UO UP UQ UR US UT UU UV UW UX UY UZ VA VB VC VD VE VF VG VH VI VJ VK VL VM VN VO VP VQ VR VS VT VU VV VW VX VY VZ WA WB WC WD WE WF WG WH WI WJ WK WL WM WN WO WP WQ WR WS WT WU WV WW WX WY WZ XA XB XC XD XE XF XG XH XI XJ XK XL XM XN XO XP XQ XR XS XT XU XV XW XX XY XZ YA YB YC YD YE YF YG YH YI YJ YK YL YM YN YO YP YQ YR YS YT YU YV YW YX YY YZ ZA ZB ZC ZD ZE ZF ZG ZH ZI ZJ ZK ZL ZM ZN ZO ZP ZQ ZR ZS ZT ZU ZV ZW ZX ZY ZZ



IWANSON
AR 281/00
12,0 cm/4³/₄"
für Kronen
for crowns



IWANSON
AR 282/00
12,0 cm/4³/₄"
mit Tropfenspitzen für Wachs
with drop tips for wax



1/1

CASTROVIEJO
AR 282/15
8,0 cm/ 3"
0-15 mm



1/1

CASTROVIEJO
AR 282/20
8,0 cm/ 3"
0-20 mm



1/1

CASTROVIEJO
AR 283/20
8,0 cm/ 3"
0-20 mm

**CASTROVIEJO-EPKER**

AR 284/09
9,0 cm/ 3¹/₂"
0-40 mm

**CASTROVIEJO-EPKER**

AR 284/18
18,0 cm/ 7"
0-40 mm

KNOCHENINSTRUMENTE
BONE INSTRUMENTS
INSTRUMENTOS PARA HUESO
INSTRUMENTS A L'OS
STRUMENTI PER OSSO

KA

nopa[®] instruments



Meißel und Osteotome
 Chisels, Gouges and Osteotomes
 Cinceles y Gubias
 Ciseaux-Burins et Ostéotomes
 Scalpelli, Osteotomi, Sgorbie

AA
AB
AC
AD
AE
AF
AK
AL
AO
AR
KA
KL
KU
PA
PB
PF
PI
PK
PL
PM
PP
PS
PT
PU
PV
KYE



	HOKE
mm	14,0 cm/5 1/2"
3	KA 404/03
5	KA 404/05
6	KA 404/06
8	KA 404/08
9	KA 404/09



	LUCAS
mm	16,0 cm/6 1/4"
4	KA 406/04
6	KA 406/06



	LUCAS
mm	16,0 cm/6 1/4"
3	KA 407/03
5	KA 407/05

Meißel und Osteotome
 Chisels, Gouges and Osteotomes
 Cinceles y Gubias
 Ciseaux-Burins et Ostéotomes
 Scalpelli, Osteotomi, Sgorbie



ALEXANDER
 18,0 cm/7"

mm	
4	KA 418/04
6	KA 418/06
8	KA 418/08
10	KA 418/10
12	KA 418/12
14	KA 418/14



ALEXANDER
 18,0 cm/7"

mm	
4	KA 419/04
6	KA 419/06
8	KA 419/08
10	KA 419/10
12	KA 419/12
14	KA 419/14

Meißel und Osteotome
 Chisels, Gouges and Osteotomes
 Cinceles y Gubias
 Ciseaux-Burins et Ostéotomes
 Scalpelli, Osteotomi, Sgorbie

AA
AB
AC
AD
AE
AF
AK
AL
AO
AR
KA
KL
KU
PA
PB
PF
PI
PK
PL
PM
PP
PS
PT
PU
PV
KYE



1/2



1/2

PARTSCH

13,5 cm/5 1/4"

17,0 cm/6 3/4"

mm

13,5 cm/5 1/4"

17,0 cm/6 3/4"

KA 433/02
 KA 433/03
 KA 433/04
 KA 433/05
 KA 433/06
 KA 433/07
 KA 433/08

KA 437/02
 KA 437/03
 KA 437/04
 KA 437/05
 KA 437/06
 KA 437/07
 KA 437/08

2
 3
 4
 5
 6
 7
 8

KA 443/02
 KA 443/03
 KA 443/04
 KA 443/05
 KA 443/06
 KA 443/07
 KA 443/08

KA 447/02
 KA 447/03
 KA 447/04
 KA 447/05
 KA 447/06
 KA 447/07
 KA 447/08

Meißel und Osteotome
 Chisels, Gouges and Osteotomes
 Cinceles y Gubias
 Ciseaux-Burins et Ostéotomes
 Scalpelli, Osteotomi, Sgorbie



MINI-LEXER
 18,0 cm/7"

mm	
4	KA 470/04
6	KA 470/06
8	KA 470/08
10	KA 470/10
12	KA 470/12
15	KA 470/15
20	KA 470/20



MINI-LEXER
 18,0 cm/7"

	KA 471/04
	KA 471/06
	KA 471/08
	KA 471/10
	KA 471/12
	KA 471/15
	KA 471/20

Ferrozellgriff
 Hartpress-Handle
 Mango en "Ferrozell"
 Manche en "Ferrozell"
 Manico in "Ferrozell"

Hämmer
Mallets
Martillos
Marteaux
Martelli



COLLIN
KA 532/22
20,0 cm/8"

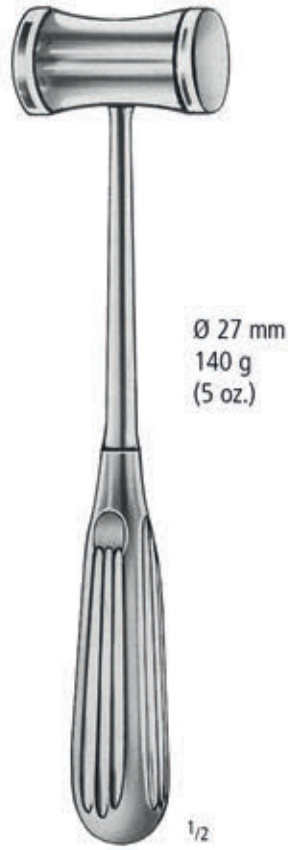

HAJEK
KA 533/14
22,0 cm/8 3/4"

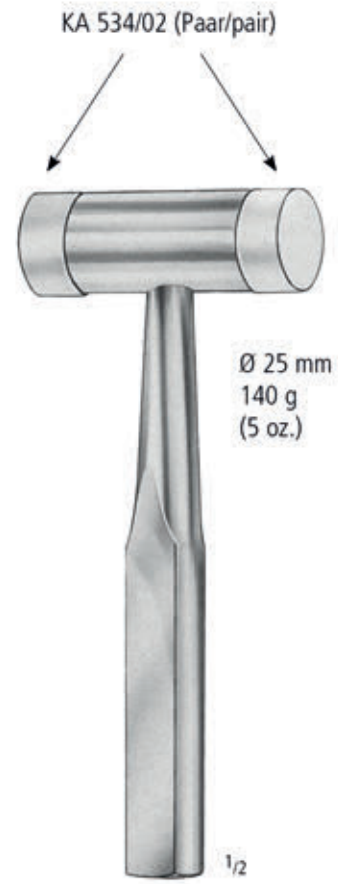

KA 534/14
18,0 cm/7"

AA
AB
AC
AD
AE
AF
AK
AL
AO
AR
KA
KL
KU
PA
PB
PF
PI
PK
PL
PM
PP
PS
PT
PU
PV
KYE

Hämmer
Mallets
Martillos
Marteaux
Martelli

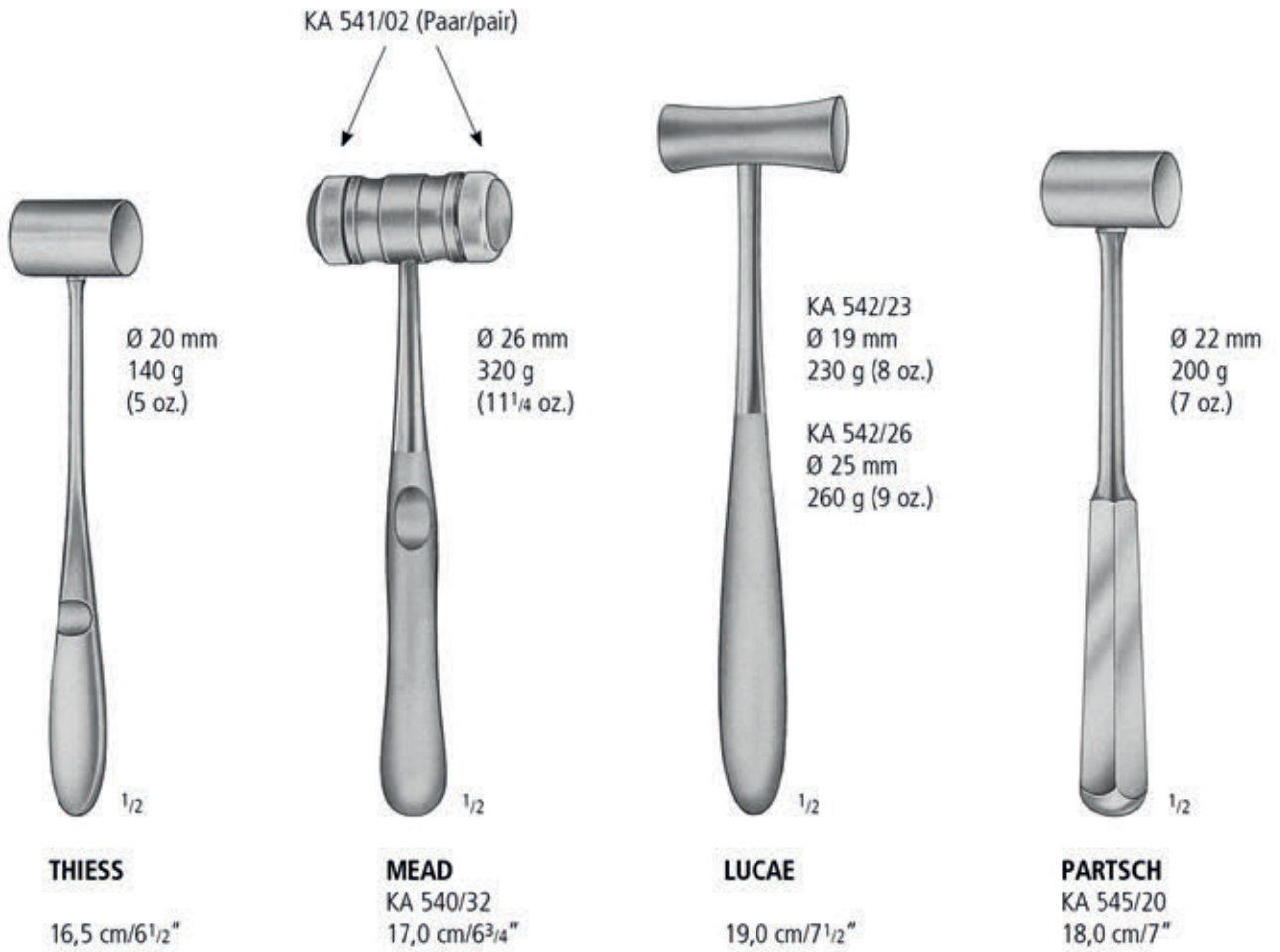

KA 535/16

KA 536/16

bleigefüllt
lead filled
relleno de plomo
garni de plomb
guarnito di piombo

Messing, massiv
brass, solid
latón, macizo
laiton, solide
ottone, solido

Scharfe Löffel
 Bone Curettes
 Cucharillas cortantes
 Curettes tranchantes
 Curette taglienti



VOLKMANN
 17,0 cm/6³/₄"

- Fig. 0000
KA 600/00
- Fig. 000
KA 601/00
- Fig. 00
KA 602/00
- Fig. 0
KA 603/00
- Fig. 1
KA 603/01



BRUNS
 17,0 cm/6³/₄"

- Fig. 000
KA 610/00
- Fig. 00
KA 611/00
- Fig. 0
KA 612/00



SPRATT
 17,0 cm/6³/₄"

- Fig. 000
KA 615/00
- Fig. 00
KA 616/00
- Fig. 0
KA 617/00



SCHEDE
 17,0 cm/6³/₄"

- Fig. 000
KA 620/00
- Fig. 00
KA 621/00
- Fig. 0
KA 622/00

AA
 AB
 AC
 AD
 AE
 AF
 AK
 AL
 AO
 AR
KA
 KL
 KU
 PA
 PB
 PF
 PI
 PK
 PL
 PM
 PP
 PS
 PT
 PU
 PV
 KYE

Scharfe Löffel
 Bone Currettes
 Cucharillas cortantes
 Currettes tranchantes
 Curette taglienti

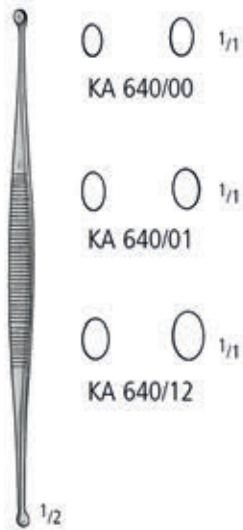

WILLIGER
 13,5 cm/5 1/4"

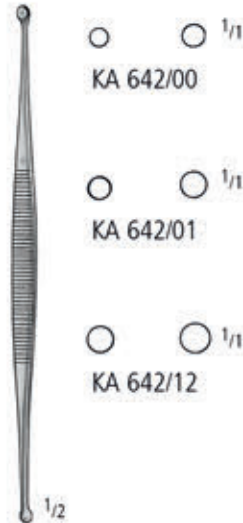

MARTINI
 13,5 cm/5 1/4"



JANSEN
 KA 644/16
 16,0 cm/6 1/4"



JANSEN
 KA 645/15
 15,0 cm/6"

Scharfe Löffel
 Bone Curettes
 Cucharillas cortantes
 Curettes tranchantes
 Curette taglienti



HEMINGWAY
 19,0 cm/7 1/2"

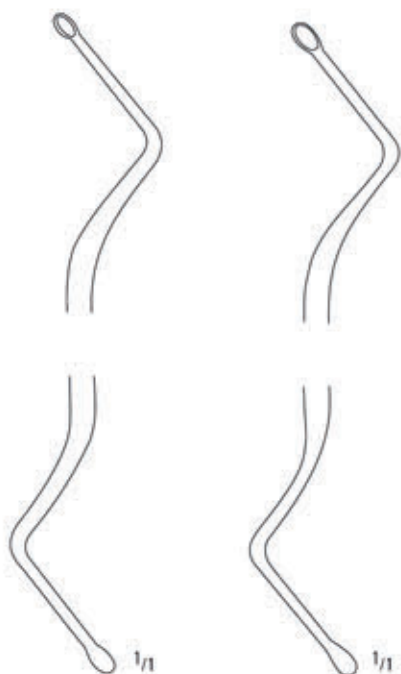

KA 654/11
 19,0 cm/7 1/2"

KA 654/22
 19,0 cm/7 1/2"



KA 654/33
 19,0 cm/7 1/2"



LUCAS
 17,0 cm/6 3/4"

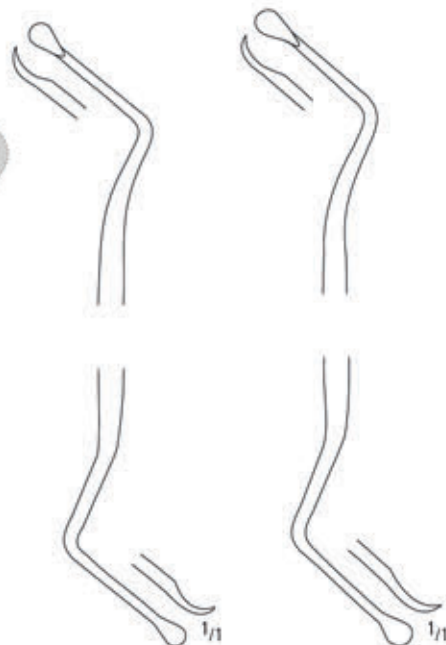

KA 654/85
 17,0 cm/6 3/4"

KA 654/86
 17,0 cm/6 3/4"

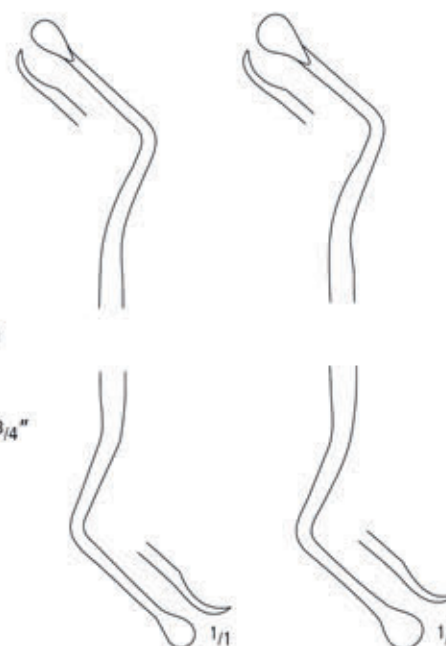

KA 654/87
 17,0 cm/6 3/4"

KA 654/88
 17,0 cm/6 3/4"

AA
 AB
 AC
 AD
 AE
 AF
 AG
 AH
 AI
 AJ
 AK
 AL
 AM
 AN
 AO
 AP
 AQ
 AR
 AS
 AT
 AU
 AV
 AW
 AX
 AY
 AZ
 BA
 BB
 BC
 BD
 BE
 BF
 BG
 BH
 BI
 BJ
 BK
 BL
 BM
 BN
 BO
 BP
 BQ
 BR
 BS
 BT
 BU
 BV
 BW
 BX
 BY
 BZ
 CA
 CB
 CC
 CD
 CE
 CF
 CG
 CH
 CI
 CJ
 CK
 CL
 CM
 CN
 CO
 CP
 CQ
 CR
 CS
 CT
 CU
 CV
 CW
 CX
 CY
 CZ
 DA
 DB
 DC
 DD
 DE
 DF
 DG
 DH
 DI
 DJ
 DK
 DL
 DM
 DN
 DO
 DP
 DQ
 DR
 DS
 DT
 DU
 DV
 DW
 DX
 DY
 DZ
 EA
 EB
 EC
 ED
 EE
 EF
 EG
 EH
 EI
 EJ
 EK
 EL
 EM
 EN
 EO
 EP
 EQ
 ER
 ES
 ET
 EU
 EV
 EW
 EX
 EY
 EZ
 FA
 FB
 FC
 FD
 FE
 FF
 FG
 FH
 FI
 FJ
 FK
 FL
 FM
 FN
 FO
 FP
 FQ
 FR
 FS
 FT
 FU
 FV
 FW
 FX
 FY
 FZ
 GA
 GB
 GC
 GD
 GE
 GF
 GG
 GH
 GI
 GJ
 GK
 GL
 GM
 GN
 GO
 GP
 GQ
 GR
 GS
 GT
 GU
 GV
 GW
 GX
 GY
 GZ
 HA
 HB
 HC
 HD
 HE
 HF
 HG
 HH
 HI
 HJ
 HK
 HL
 HM
 HN
 HO
 HP
 HQ
 HR
 HS
 HT
 HU
 HV
 HW
 HX
 HY
 HZ
 IA
 IB
 IC
 ID
 IE
 IF
 IG
 IH
 II
 IJ
 IK
 IL
 IM
 IN
 IO
 IP
 IQ
 IR
 IS
 IT
 IU
 IV
 IW
 IX
 IY
 IZ
 JA
 JB
 JC
 JD
 JE
 JF
 JG
 JH
 JI
 JJ
 JK
 JL
 JM
 JN
 JO
 JP
 JQ
 JR
 JS
 JT
 JU
 JV
 JW
 JX
 JY
 JZ
 KA
 KB
 KC
 KD
 KE
 KF
 KG
 KH
 KI
 KJ
 KK
 KL
 KM
 KN
 KO
 KP
 KQ
 KR
 KS
 KT
 KU
 KV
 KW
 KX
 KY
 KZ
 LA
 LB
 LC
 LD
 LE
 LF
 LG
 LH
 LI
 LJ
 LK
 LL
 LM
 LN
 LO
 LP
 LQ
 LR
 LS
 LT
 LU
 LV
 LW
 LX
 LY
 LZ
 MA
 MB
 MC
 MD
 ME
 MF
 MG
 MH
 MI
 MJ
 MK
 ML
 MM
 MN
 MO
 MP
 MQ
 MR
 MS
 MT
 MU
 MV
 MW
 MX
 MY
 MZ
 NA
 NB
 NC
 ND
 NE
 NF
 NG
 NH
 NI
 NJ
 NK
 NL
 NM
 NN
 NO
 NP
 NQ
 NR
 NS
 NT
 NU
 NV
 NW
 NX
 NY
 NZ
 OA
 OB
 OC
 OD
 OE
 OF
 OG
 OH
 OI
 OJ
 OK
 OL
 OM
 ON
 OO
 OP
 OQ
 OR
 OS
 OT
 OU
 OV
 OW
 OX
 OY
 OZ
 PA
 PB
 PC
 PD
 PE
 PF
 PG
 PH
 PI
 PJ
 PK
 PL
 PM
 PN
 PO
 PP
 PQ
 PR
 PS
 PT
 PU
 PV
 PW
 PX
 PY
 PZ
 QA
 QB
 QC
 QD
 QE
 QF
 QG
 QH
 QI
 QJ
 QK
 QL
 QM
 QN
 QO
 QP
 QQ
 QR
 QS
 QT
 QU
 QV
 QW
 QX
 QY
 QZ
 RA
 RB
 RC
 RD
 RE
 RF
 RG
 RH
 RI
 RJ
 RK
 RL
 RM
 RN
 RO
 RP
 RQ
 RR
 RS
 RT
 RU
 RV
 RW
 RX
 RY
 RZ
 SA
 SB
 SC
 SD
 SE
 SF
 SG
 SH
 SI
 SJ
 SK
 SL
 SM
 SN
 SO
 SP
 SQ
 SR
 SS
 ST
 SU
 SV
 SW
 SX
 SY
 SZ
 TA
 TB
 TC
 TD
 TE
 TF
 TG
 TH
 TI
 TJ
 TK
 TL
 TM
 TN
 TO
 TP
 TQ
 TR
 TS
 TT
 TU
 TV
 TW
 TX
 TY
 TZ
 UA
 UB
 UC
 UD
 UE
 UF
 UG
 UH
 UI
 UJ
 UK
 UL
 UM
 UN
 UO
 UP
 UQ
 UR
 US
 UT
 UU
 UV
 UW
 UX
 UY
 UZ
 VA
 VB
 VC
 VD
 VE
 VF
 VG
 VH
 VI
 VJ
 VK
 VL
 VM
 VN
 VO
 VP
 VQ
 VR
 VS
 VT
 VU
 VV
 VW
 VX
 VY
 VZ
 WA
 WB
 WC
 WD
 WE
 WF
 WG
 WH
 WI
 WJ
 WK
 WL
 WM
 WN
 WO
 WP
 WQ
 WR
 WS
 WT
 WU
 WV
 WW
 WX
 WY
 WZ
 XA
 XB
 XC
 XD
 XE
 XF
 XG
 XH
 XI
 XJ
 XK
 XL
 XM
 XN
 XO
 XP
 XQ
 XR
 XS
 XT
 XU
 XV
 XW
 XX
 XY
 XZ
 YA
 YB
 YC
 YD
 YE
 YF
 YG
 YH
 YI
 YJ
 YK
 YL
 YM
 YN
 YO
 YP
 YQ
 YR
 YS
 YT
 YU
 YV
 YW
 YX
 YZ
 ZA
 ZB
 ZC
 ZD
 ZE
 ZF
 ZG
 ZH
 ZI
 ZJ
 ZK
 ZL
 ZM
 ZN
 ZO
 ZP
 ZQ
 ZR
 ZS
 ZT
 ZU
 ZV
 ZW
 ZX
 ZY
 ZZ

Raspatorien
 Raspatories
 Raspadores
 Rugines-Raspatoires
 Periostotomi



WILLIGER
 KA 680/13
 13,0 cm/5"



WILLIGER
 KA 680/16
 16,0 cm/6 1/4"

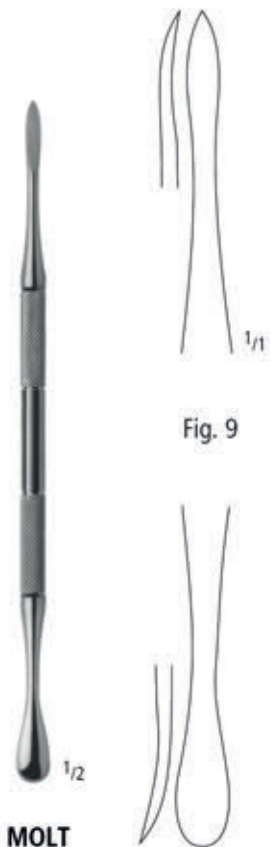
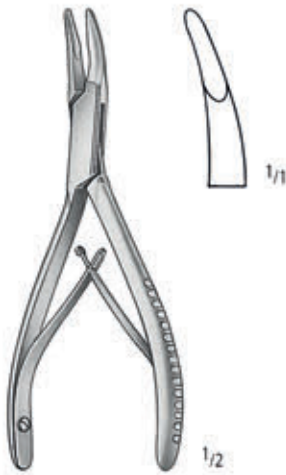

Fig. 9

MOLT
 KA 682/09
 18,0 cm/7"

Hohlmeißelzangen
 Bone Rongeurs
 Pinzas-gubias
 Pincès-gouges
 Pinze-sgorbie



MINI-FRIEDMAN
 KA 800/12
 12,0 cm/4³/₄"



FRIEDMAN
 KA 800/14
 14,0 cm/5¹/₂"

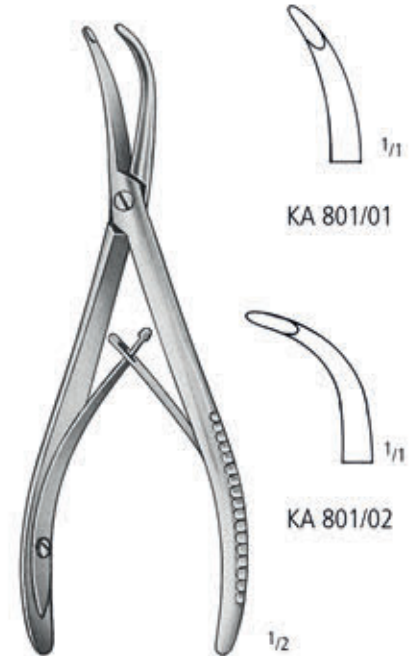

STELLBRINK
 17,0 cm/6³/₄"

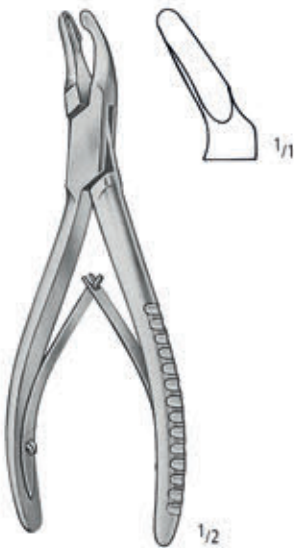

CLEVELAND
 KA 802/14
 14,0 cm/5¹/₂"

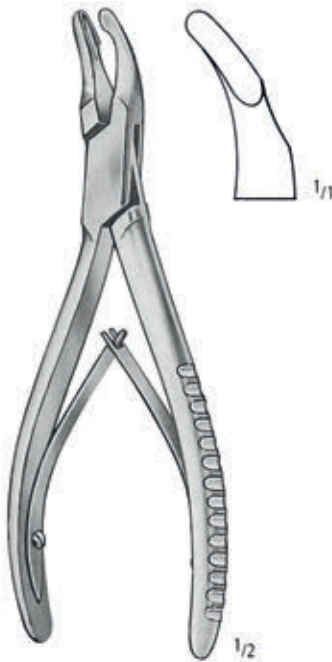

CLEVELAND
 KA 802/17
 17,0 cm/6³/₄"

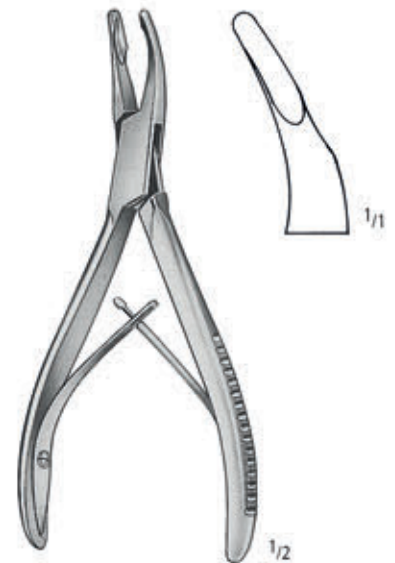

UNIVERSAL
 KA 803/13
 13,5 cm/5¹/₄"

AA
 AB
 AC
 AD
 AE
 AF
 AK
 AL
 AO
 AR
KA
 KL
 KU
 PA
 PB
 PF
 PI
 PK
 PL
 PM
 PP
 PS
 PT
 PU
 PV
 KYE

Hohlmeißelzangen
 Bone Rongeurs
 Pinzas-gubias
 Pincès-gouges
 Pinze-sgorbie

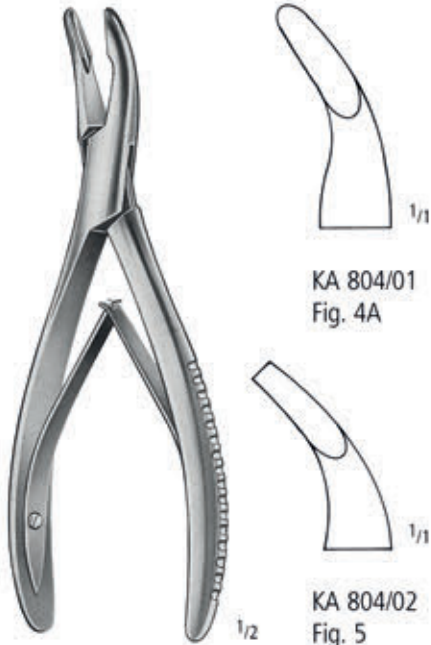

MEAD
16,5 cm/6 1/2"

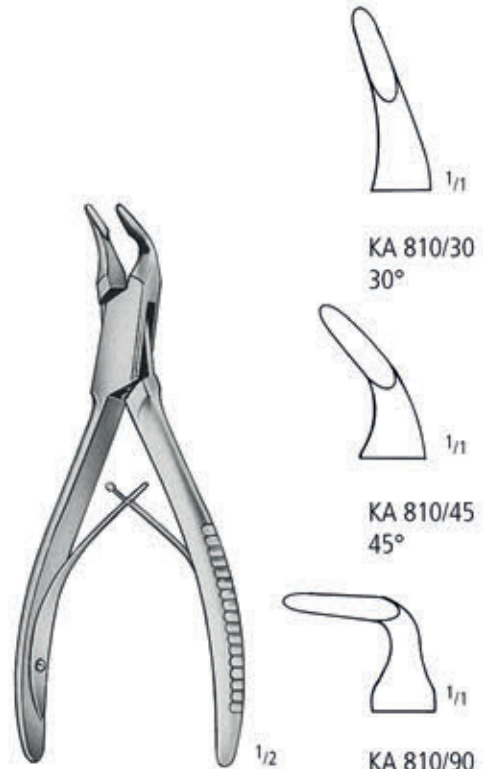

BLUMENTHAL
15,5 cm/6"

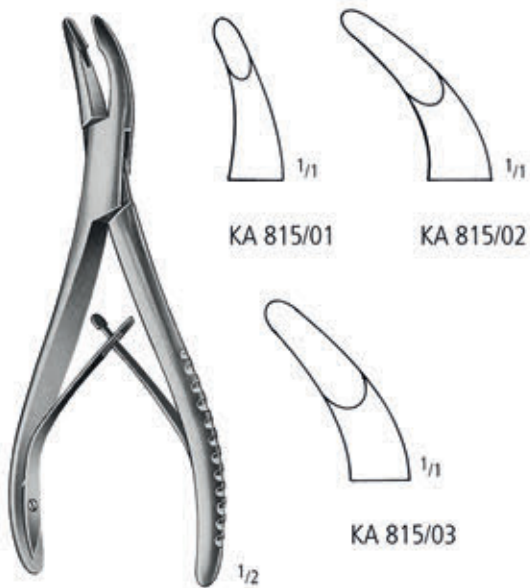

LUER
15,0 cm/6"



MAYFIELD
KA 823/17
17,0 cm/6 3/4"

Hohlmeißelzangen
 Bone Rongeurs
 Pinzas-gubias
 Pincès-gouges
 Pinze-sgorbie

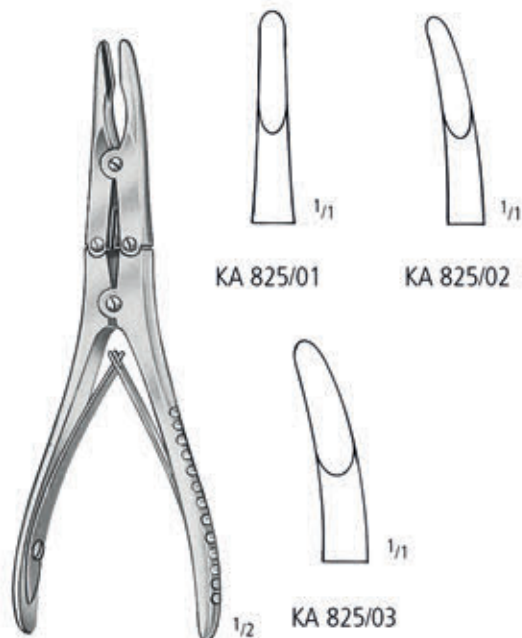

BÖHLER
 15,0 cm/6"

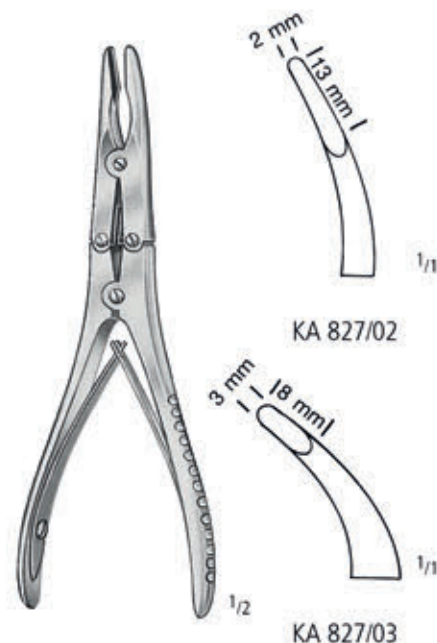

KLEINERT-KUTZ
 15,0 cm/6"



RUSKIN-MINI
 KA 829/15
 15,0 cm/6"



BEYER
 KA 830/18
 18,0 cm/7"

AA
 AB
 AC
 AD
 AE
 AF
 AG
 AH
 AI
 AJ
 AK
 AL
 AM
 AN
 AO
 AP
 AQ
 AR
 AS
 AT
 AU
 AV
 AW
 AX
 AY
 AZ
 BA
 BB
 BC
 BD
 BE
 BF
 BG
 BH
 BI
 BJ
 BK
 BL
 BM
 BN
 BO
 BP
 BQ
 BR
 BS
 BT
 BU
 BV
 BW
 BX
 BY
 CA
 CB
 CC
 CD
 CE
 CF
 CG
 CH
 CI
 CJ
 CK
 CL
 CM
 CN
 CO
 CP
 CQ
 CR
 CS
 CT
 CU
 CV
 CW
 CX
 CY
 DA
 DB
 DC
 DD
 DE
 DF
 DG
 DH
 DI
 DJ
 DK
 DL
 DM
 DN
 DO
 DP
 DQ
 DR
 DS
 DT
 DU
 DV
 DW
 DX
 EY
 FZ
 GA
 GB
 GC
 GD
 GE
 GF
 GG
 GH
 GI
 GJ
 GK
 GL
 GM
 GN
 GO
 GP
 GQ
 GR
 GS
 GT
 GU
 GV
 GW
 GX
 GY
 HA
 HB
 HC
 HD
 HE
 HF
 HG
 HH
 HI
 HJ
 HK
 HL
 HM
 HN
 HO
 HP
 HQ
 HR
 HS
 HT
 HU
 HV
 HW
 HX
 HY
 IA
 IB
 IC
 ID
 IE
 IF
 IG
 IH
 II
 IJ
 IK
 IL
 IM
 IN
 IO
 IP
 IQ
 IR
 IS
 IT
 IU
 IV
 IW
 IX
 IY
 JA
 JB
 JC
 JD
 JE
 JF
 JG
 JH
 JI
 JJ
 JK
 JL
 JM
 JN
 JO
 JP
 JQ
 JR
 JS
 JT
 JU
 JV
 JW
 JX
 JY
 KA
 KB
 KC
 KD
 KE
 KF
 KG
 KH
 KI
 KJ
 KK
 KL
 KM
 KN
 KO
 KP
 KQ
 KR
 KS
 KT
 KU
 KV
 KW
 KX
 KY
 LA
 LB
 LC
 LD
 LE
 LF
 LG
 LH
 LI
 LJ
 LK
 LL
 LM
 LN
 LO
 LP
 LQ
 LR
 LS
 LT
 LU
 LV
 LW
 LX
 LY
 MA
 MB
 MC
 MD
 ME
 MF
 MG
 MH
 MI
 MJ
 MK
 ML
 MM
 MN
 MO
 MP
 MQ
 MR
 MS
 MT
 MU
 MV
 MW
 MX
 MY
 NA
 NB
 NC
 ND
 NE
 NF
 NG
 NH
 NI
 NJ
 NK
 NL
 NM
 NN
 NO
 NP
 NQ
 NR
 NS
 NT
 NU
 NV
 NW
 NX
 NY
 OA
 OB
 OC
 OD
 OE
 OF
 OG
 OH
 OI
 OJ
 OK
 OL
 OM
 ON
 OO
 OP
 OQ
 OR
 OS
 OT
 OU
 OV
 OW
 OX
 OY
 PA
 PB
 PC
 PD
 PE
 PF
 PG
 PH
 PI
 PJ
 PK
 PL
 PM
 PN
 PO
 PP
 PQ
 PR
 PS
 PT
 PU
 PV
 PW
 PX
 PY
 QA
 QB
 QC
 QD
 QE
 QF
 QG
 QH
 QI
 QJ
 QK
 QL
 QM
 QN
 QO
 QP
 QQ
 QR
 QS
 QT
 QU
 QV
 QW
 QX
 QY
 RA
 RB
 RC
 RD
 RE
 RF
 RG
 RH
 RI
 RJ
 RK
 RL
 RM
 RN
 RO
 RP
 RQ
 RR
 RS
 RT
 RU
 RV
 RW
 RX
 RY
 SA
 SB
 SC
 SD
 SE
 SF
 SG
 SH
 SI
 SJ
 SK
 SL
 SM
 SN
 SO
 SP
 SQ
 SR
 SS
 ST
 SU
 SV
 SW
 SX
 SY
 TA
 TB
 TC
 TD
 TE
 TF
 TG
 TH
 TI
 TJ
 TK
 TL
 TM
 TN
 TO
 TP
 TQ
 TR
 TS
 TT
 TU
 TV
 TW
 TX
 TY
 UA
 UB
 UC
 UD
 UE
 UF
 UG
 UH
 UI
 UJ
 UK
 UL
 UM
 UN
 UO
 UP
 UQ
 UR
 US
 UT
 UY
 VA
 VB
 VC
 VD
 VE
 VF
 VG
 VH
 VI
 VJ
 VK
 VL
 VM
 VN
 VO
 VP
 VQ
 VR
 VS
 VT
 VY
 WA
 WB
 WC
 WD
 WE
 WF
 WG
 WH
 WI
 WJ
 WK
 WL
 WM
 WN
 WO
 WP
 WQ
 WR
 WS
 WT
 WY
 XA
 XB
 XC
 XD
 XE
 XF
 XG
 XH
 XI
 XJ
 XK
 XL
 XM
 XN
 XO
 XP
 XQ
 XR
 XS
 XT
 XY
 YA
 YB
 YC
 YD
 YE
 YF
 YG
 YH
 YI
 YJ
 YK
 YL
 YM
 YN
 YO
 YP
 YQ
 YR
 YS
 YT
 YU
 YV
 YW
 YX
 YZ
 ZA
 ZB
 ZC
 ZD
 ZE
 ZF
 ZG
 ZH
 ZI
 ZJ
 ZK
 ZL
 ZM
 ZN
 ZO
 ZP
 ZQ
 ZR
 ZS
 ZT
 ZU
 ZV
 ZW
 ZX
 ZY

Hohlmeißelzangen
 Bone Rongeurs
 Pinzas-gubias
 Pincès-gouges
 Pinze-sgorbie



ZAUFAL-JANSEN
 KA 835/18
 18,0 cm/7"

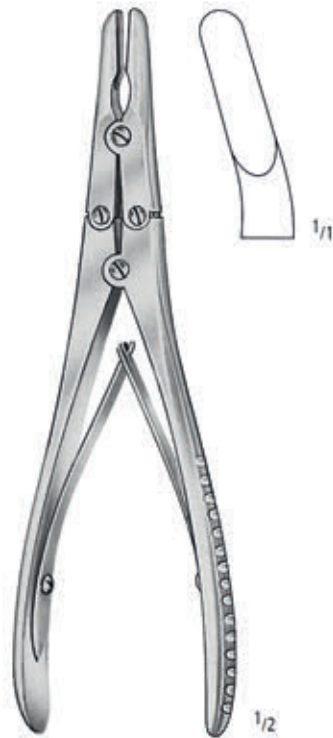

RUSKIN
 KA 836/18
 18,0 cm/7"



RUSKIN
 KA 862/23
 23,0 cm/9"

Hohlmeißelzangen
 Bone Rongeurs
 Pinzas-gubias
 Pincers-gouges
 Pinze-sgorbie

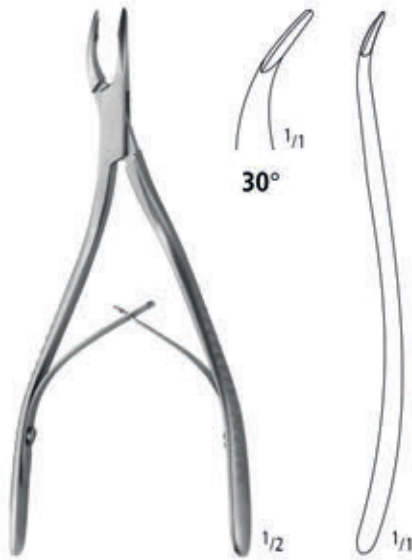

MICRO-FRIEDMAN
 KA 865/14
 14,5 cm/5³/₄"

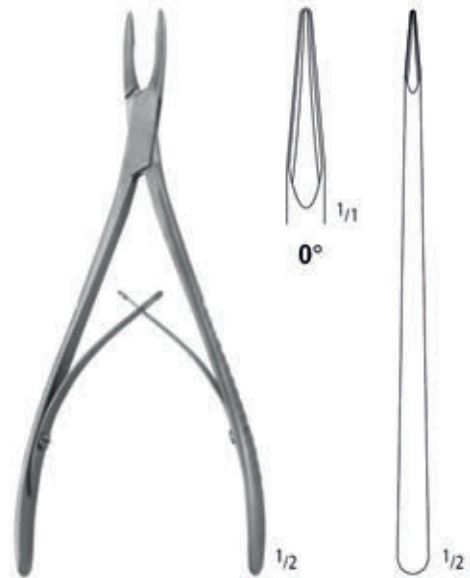

MICRO-FRIEDMAN
 KA 866/15
 15,0 cm/6"

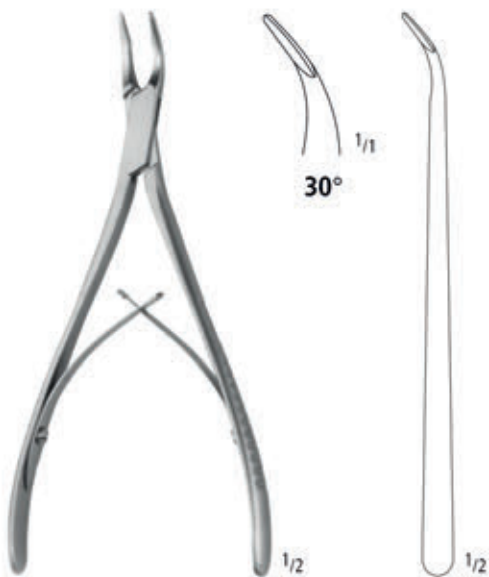

MICRO-FRIEDMAN
 KA 867/15
 15,0 cm/6"

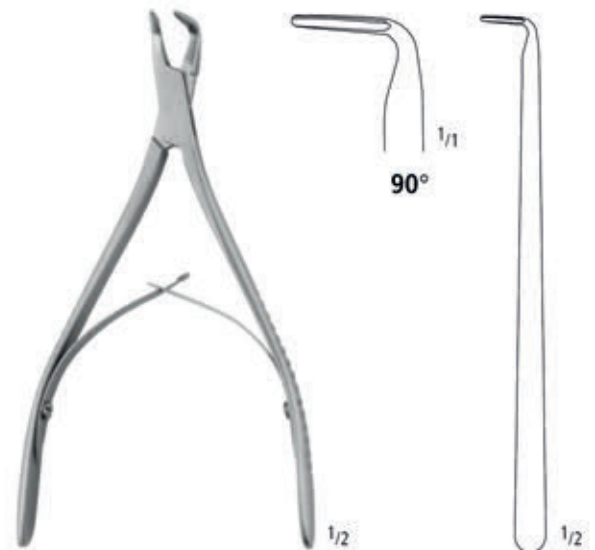

MICRO-FRIEDMAN
 KA 868/15
 14,5 cm/5³/₄"

AA
 AB
 AC
 AD
 AE
 AF
 AG
 AH
 AI
 AJ
 AK
 AL
 AM
 AN
 AO
 AP
 AQ
 AR
 AS
 AT
 AU
 AV
 AW
 AX
 AY
 AZ
 BA
 BB
 BC
 BD
 BE
 BF
 BG
 BH
 BI
 BJ
 BK
 BL
 BM
 BN
 BO
 BP
 BQ
 BR
 BS
 BT
 BU
 BV
 BW
 BX
 BY
 BZ
 CA
 CB
 CC
 CD
 CE
 CF
 CG
 CH
 CI
 CJ
 CK
 CL
 CM
 CN
 CO
 CP
 CQ
 CR
 CS
 CT
 CU
 CV
 CW
 CX
 CY
 CZ
 DA
 DB
 DC
 DD
 DE
 DF
 DG
 DH
 DI
 DJ
 DK
 DL
 DM
 DN
 DO
 DP
 DQ
 DR
 DS
 DT
 DU
 DV
 DW
 DX
 DY
 DZ
 EA
 EB
 EC
 ED
 EE
 EF
 EG
 EH
 EI
 EJ
 EK
 EL
 EM
 EN
 EO
 EP
 EQ
 ER
 ES
 ET
 EU
 EV
 EW
 EX
 EY
 EZ
 FA
 FB
 FC
 FD
 FE
 FF
 FG
 FH
 FI
 FJ
 FK
 FL
 FM
 FN
 FO
 FP
 FQ
 FR
 FS
 FT
 FU
 FV
 FW
 FX
 FY
 FZ
 GA
 GB
 GC
 GD
 GE
 GF
 GG
 GH
 GI
 GJ
 GK
 GL
 GM
 GN
 GO
 GP
 GQ
 GR
 GS
 GT
 GU
 GV
 GW
 GX
 GY
 GZ
 HA
 HB
 HC
 HD
 HE
 HF
 HG
 HH
 HI
 HJ
 HK
 HL
 HM
 HN
 HO
 HP
 HQ
 HR
 HS
 HT
 HU
 HV
 HW
 HX
 HY
 HZ
 IA
 IB
 IC
 ID
 IE
 IF
 IG
 IH
 II
 IJ
 IK
 IL
 IM
 IN
 IO
 IP
 IQ
 IR
 IS
 IT
 IU
 IV
 IW
 IX
 IY
 IZ
 JA
 JB
 JC
 JD
 JE
 JF
 JG
 JH
 JI
 JJ
 JK
 JL
 JM
 JN
 JO
 JP
 JQ
 JR
 JS
 JT
 JU
 JV
 JW
 JX
 JY
 JZ
 KA
 KB
 KC
 KD
 KE
 KF
 KG
 KH
 KI
 KJ
 KK
 KL
 KM
 KN
 KO
 KP
 KQ
 KR
 KS
 KT
 KU
 KV
 KW
 KX
 KY
 KZ
 LA
 LB
 LC
 LD
 LE
 LF
 LG
 LH
 LI
 LJ
 LK
 LL
 LM
 LN
 LO
 LP
 LQ
 LR
 LS
 LT
 LU
 LV
 LW
 LX
 LY
 LZ
 MA
 MB
 MC
 MD
 ME
 MF
 MG
 MH
 MI
 MJ
 MK
 ML
 MM
 MN
 MO
 MP
 MQ
 MR
 MS
 MT
 MU
 MV
 MW
 MX
 MY
 MZ
 NA
 NB
 NC
 ND
 NE
 NF
 NG
 NH
 NI
 NJ
 NK
 NL
 NM
 NN
 NO
 NP
 NQ
 NR
 NS
 NT
 NU
 NV
 NW
 NX
 NY
 NZ
 OA
 OB
 OC
 OD
 OE
 OF
 OG
 OH
 OI
 OJ
 OK
 OL
 OM
 ON
 OO
 OP
 OQ
 OR
 OS
 OT
 OU
 OV
 OW
 OX
 OY
 OZ
 PA
 PB
 PC
 PD
 PE
 PF
 PG
 PH
 PI
 PJ
 PK
 PL
 PM
 PN
 PO
 PP
 PQ
 PR
 PS
 PT
 PU
 PV
 PW
 PX
 PY
 PZ
 QA
 QB
 QC
 QD
 QE
 QF
 QG
 QH
 QI
 QJ
 QK
 QL
 QM
 QN
 QO
 QP
 QQ
 QR
 QS
 QT
 QU
 QV
 QW
 QX
 QY
 QZ
 RA
 RB
 RC
 RD
 RE
 RF
 RG
 RH
 RI
 RJ
 RK
 RL
 RM
 RN
 RO
 RP
 RQ
 RR
 RS
 RT
 RU
 RV
 RW
 RX
 RY
 RZ
 SA
 SB
 SC
 SD
 SE
 SF
 SG
 SH
 SI
 SJ
 SK
 SL
 SM
 SN
 SO
 SP
 SQ
 SR
 SS
 ST
 SU
 SV
 SW
 SX
 SY
 SZ
 TA
 TB
 TC
 TD
 TE
 TF
 TG
 TH
 TI
 TJ
 TK
 TL
 TM
 TN
 TO
 TP
 TQ
 TR
 TS
 TT
 TU
 TV
 TW
 TX
 TY
 TZ
 UA
 UB
 UC
 UD
 UE
 UF
 UG
 UH
 UI
 UJ
 UK
 UL
 UM
 UN
 UO
 UP
 UQ
 UR
 US
 UT
 UU
 UV
 UW
 UX
 UY
 UZ
 VA
 VB
 VC
 VD
 VE
 VF
 VG
 VH
 VI
 VJ
 VK
 VL
 VM
 VN
 VO
 VP
 VQ
 VR
 VS
 VT
 VU
 VV
 VW
 VX
 VY
 VZ
 WA
 WB
 WC
 WD
 WE
 WF
 WG
 WH
 WI
 WJ
 WK
 WL
 WM
 WN
 WO
 WP
 WQ
 WR
 WS
 WT
 WU
 WV
 WW
 WX
 WY
 WZ
 XA
 XB
 XC
 XD
 XE
 XF
 XG
 XH
 XI
 XJ
 XK
 XL
 XM
 XN
 XO
 XP
 XQ
 XR
 XS
 XT
 XU
 XV
 XW
 XX
 XY
 XZ
 YA
 YB
 YC
 YD
 YE
 YF
 YG
 YH
 YI
 YJ
 YK
 YL
 YM
 YN
 YO
 YP
 YQ
 YR
 YS
 YT
 YU
 YV
 YW
 YX
 YZ
 ZA
 ZB
 ZC
 ZD
 ZE
 ZF
 ZG
 ZH
 ZI
 ZJ
 ZK
 ZL
 ZM
 ZN
 ZO
 ZP
 ZQ
 ZR
 ZS
 ZT
 ZU
 ZV
 ZW
 ZX
 ZY
 ZZ

Knochensplitterzangen
 Bone Cutting Forceps
 Pinzas cortantes para huesos
 Pincès coupantes à os
 Cesioie per ossa



CLEVELAND-GARDENER
 KA 872/16
 18,0 cm/7"



LITTAUER-LISTON
 KA 882/15
 15,0 cm/6"

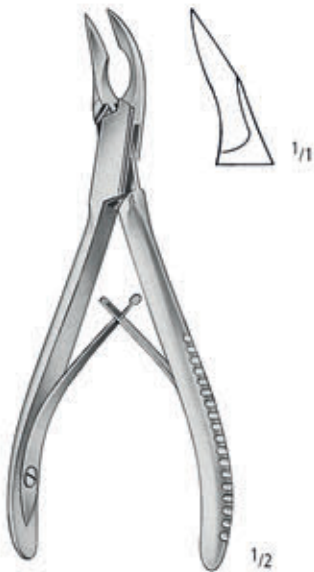

CLEVELAND
 KA 884/15
 15,0 cm/6"
 Fig. 5S



CLEVELAND
 KA 884/17
 17,0 cm/6³/₄"
 Fig. 5



KA 885/12
 12,0 cm/4³/₄"

Keilbeinstanzen
Sphenoid Punches
Pinzas para seno esfenoidal
Pinces pour sinus sphénoïdal
Pinze per seno sfenoidale

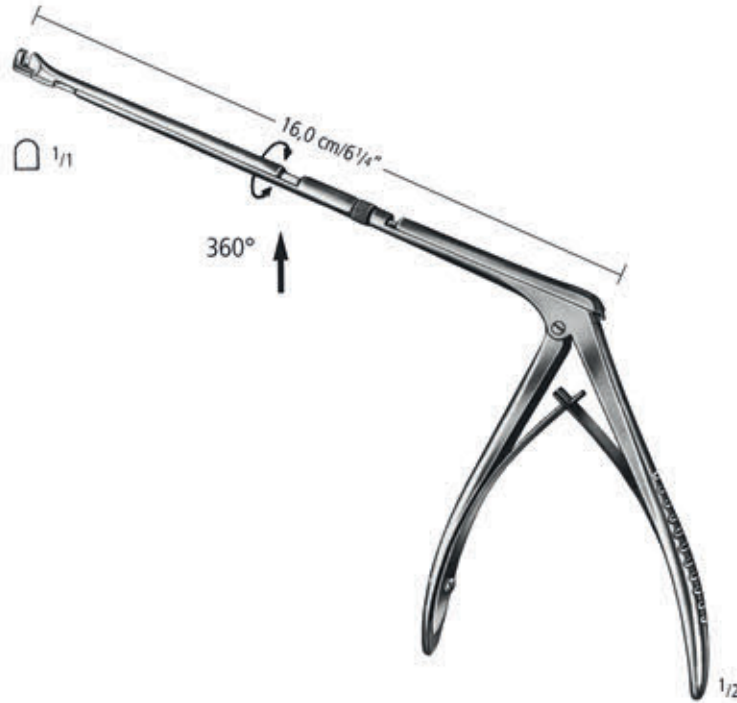

HAJEK-KOFFLER
KO 274/16



KERRISON

AA
AB
AC
AD
AE
AF
AK
AL
AO
AR
KA
KL
KU
PA
PB
PF
PI
PK
PL
PM
PP
PS
PT
PU
PV
KYE

Weisheitszahnhook
 Third molar hook
 Ganchito retractor de la muela del juicio
 Crochet à dent de sagesse
 Uncino per dente del giudizio



1/2

HENAHAN
 20,0 cm/8"



1/1

Fig. 1-1
 KA 897/01



1/1

Fig. 1-2
 KA 897/02



1/1

Fig. 1-3
 KA 897/03



MUND / ZUNGE
MOUTH / TONGUE
BOCA / LENGUA
BOUCHE / LANGUE
BOCCA / LINGUA

KL

nopa[®] instruments



KL MUND MOUTH BOCA BOUCHE BOCCA

Fingerschützer, Mundkeile, Mundsperrer
 Finger Protectors, Oral Wedges, Mouth Gags
 Dedales, Garrotes, Abre-bocas
 Doigtiers, Baillons, Ouvre-bouches
 Ditali, Apribocca



LANGENBECK

KL 015/01 KL 015/02 KL 015/03
 Ø 22,0 mm Ø 24,5 mm Ø 26,5 mm

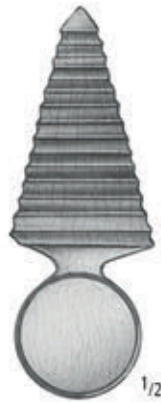

MAUNDER
 KL 018/00



PITHA
 KL 020/00



HEISTER
 KL 030/13
 13,0 cm/5"



MOLT
 KL 040/11
 11,0 cm/4 1/2"



MOLT
 KL 040/14
 14,0 cm/5 1/2"

MUND MOUTH BOCA BOUCHE BOCCA

Mundsperrer
Mouth Gags
Abre-bocas
Ouvre-bouches
Apribocca



DENHART
KL 042/12
12,0 cm/4³/₄"



ROSER-KÖNIG
16,0 cm/6¹/₄" KL 044/16
19,0 cm/7¹/₂" KL 044/19



JENNINGS
KL 046/09 9,0 cm/3¹/₂"
KL 046/11 11,0 cm/4¹/₂"
KL 046/13 13,0 cm/5"
KL 046/15 15,0 cm/6"



SEEMANN-SEIFFERT
KL 047/09
KL 047/11
KL 047/13
KL 047/15

AA AB AC AD AE AF AG AH AI AJ AK AL AM AN AO AP AQ AR AS AT AU AV AW AX AY AZ
BA BB BC BD BE BF BG BH BI BJ BK BL BM BN BO BP BQ BR BS BT BU BV BW BX BY BZ
CA CB CC CD CE CF CG CH CI CJ CK CL CM CN CO CP CQ CR CS CT CU CV CW CX CY CZ
DA DB DC DD DE DF DG DH DI DJ DK DL DM DN DO DP DQ DR DS DT DU DV DW DX DY DZ
EA EB EC ED EE EF EG EH EI EJ EK EL EM EN EO EP EQ ER ES ET EU EV EW EX EY EZ
FA FB FC FD FE FF FG FH FI FJ FK FL FM FN FO FP FQ FR FS FT FU FV FW FX FY FZ
GA GB GC GD GE GF GG GH GI GJ GK GL GM GN GO GP GQ GR GS GT GU GV GW GX GY GZ
HA HB HC HD HE HF HG HH HI HJ HK HL HM HN HO HP HQ HR HS HT HU HV HW HX HY HZ
IA IB IC ID IE IF IG IH II IJ IK IL IM IN IO IP IQ IR IS IT IU IV IW IX IY IZ
JA JB JC JD JE JF JG JH JI JJ JK JL JM JN JO JP JQ JR JS JT JU JV JW JX JY JZ
KA KB KC KD KE KF KG KH KI KJ KL KM KN KO KP KQ KR KS KT KU KV KW KX KY KZ
LA LB LC LD LE LF LG LH LI LJ LK LL LM LN LO LP LQ LR LS LT LU LV LW LX LY LZ
MA MB MC MD ME MF MG MH MI MJ MK ML MN MO MP MQ MR MS MT MU MV MW MX MY MZ
NA NB NC ND NE NF NG NH NI NJ NK NL NN NO NP NQ NR NS NT NU NV NW NX NY NZ
OA OB OC OD OE OF OG OH OI OJ OK OL OM ON OO OP OQ OR OS OT OU OV OW OX OY OZ
PA PB PC PD PE PF PG PH PI PJ PK PL PM PN PO PP PQ PR PS PT PU PV PW PX PY PZ
QA QB QC QD QE QF QG QH QI QJ QK QL QM QN QO QP QQ QR QS QT QU QV QW QX QY QZ
RA RB RC RD RE RF RG RH RI RJ RK RL RM RN RO RP RQ RR RS RT RU RV RW RX RY RZ
SA SB SC SD SE SF SG SH SI SJ SK SL SM SN SO SP SQ SR SS ST SU SV SW SX SY SZ
TA TB TC TD TE TF TG TH TI TJ TK TL TM TN TO TP TQ TR TS TT TU TV TW TX TY TZ
UA UB UC UD UE UF UG UH UI UJ UK UL UM UN UO UP UQ UR US UT UU UV UW UX UY UZ
VA VB VC VD VE VF VG VH VI VJ VK VL VM VN VO VP VQ VR VS VT VU VV VW VX VY VZ
WA WB WC WD WE WF WG WH WI WJ WK WL WM WN WO WP WQ WR WS WT WU WV WW WX WY WZ
XA XB XC XD XE XF XG XH XI XJ XK XL XM XN XO XP XQ XR XS XT XU XV XW XX XY XZ
YA YB YC YD YE YF YG YH YI YJ YK YL YM YN YO YP YQ YR YS YT YU YV YW YX YY YZ
ZA ZB ZC ZD ZE ZF ZG ZH ZI ZJ ZK ZL ZM ZN ZO ZP ZQ ZR ZS ZT ZU ZV ZW ZX ZY ZZ

KL

KL MUND MOUTH BOCA BOUCHE BOCCA

Mundsperrer
 Mouth Gags
 Abre-bocas
 Ouvre-bouches
 Apribocca

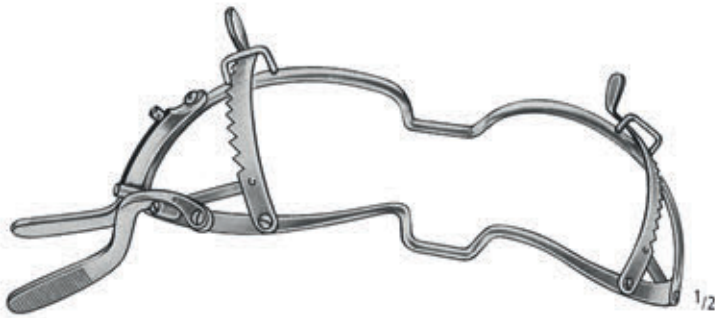

WHITEHEAD

KL 048/11
 KL 048/13
 KL 048/15

11,0 cm/4¹/₃"
 13,0 cm/5"
 15,0 cm/6"

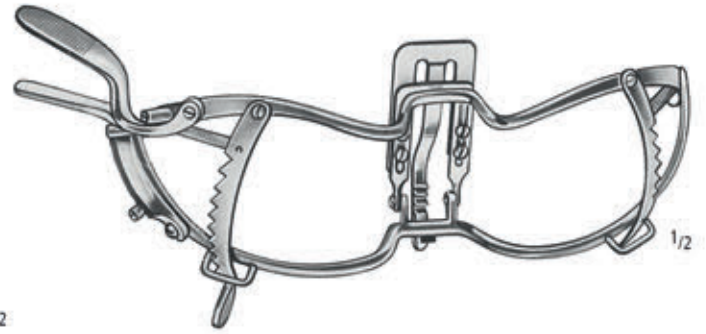

WHITEHEAD

KL 049/11
 KL 049/13
 KL 049/15



KILNER-DOUGHTY

KL 060/00

komplett
 complete
 completo
 complet
 completo

KL 060/04
 Sperrer alleine
 Gag only
 Abre-boca suelto
 Ouvre-bouche seul
 Apribocca solo



Fig. 1
 KL 060/01
 65x28 mm



Fig. 2
 KL 060/02
 75x32 mm



Fig. 3
 KL 060/03
 80x37 mm



KL 060/08

MUND MOUTH BOCA BOUCHE BOCCA

Mundsperr
Mouth Gags
Abre-bocas
Ouvre-bouches
Apribocca



Fig. 1
KL 061/01
55x25 mm



Fig. 2
KL 061/02
60x27 mm



Fig. 3
KL 061/03
70x30 mm

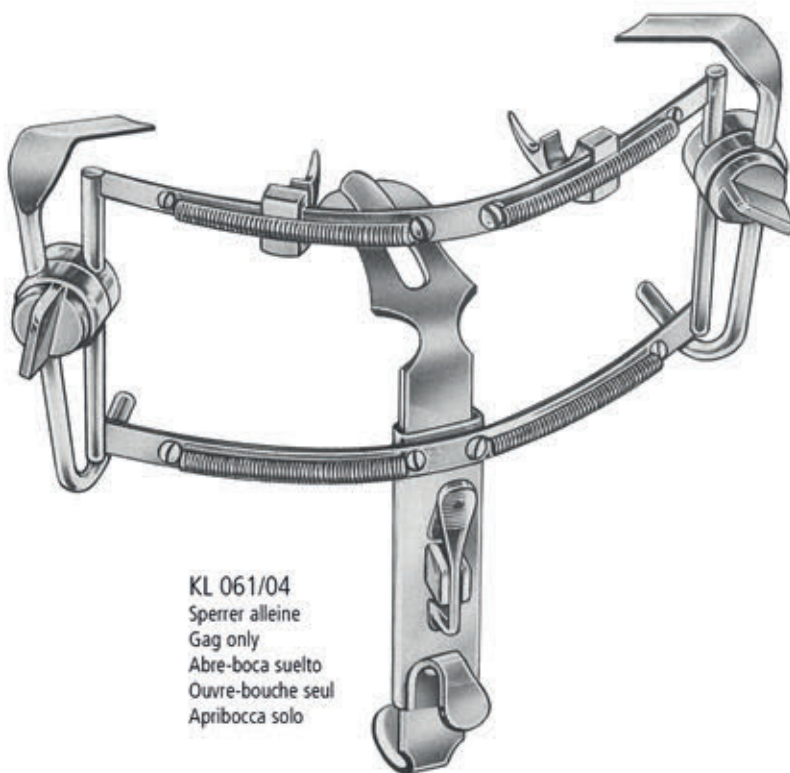

KL 061/04
Sperrer alleine
Gag only
Abre-boca suelto
Ouvre-bouche seul
Apribocca solo

DINGMANN

KL 061/00
komplett
complete
completo
complet
completo



KL 064/06
Sperrer alleine
Gag only
Abre-boca suelto
Ouvre-bouche seul
Apribocca solo

DAVIS-BOYLE
KL 064/00
komplett
complete
completo
complet
completo



Fig. 1
KL 064/01
105x27 mm



Fig. 2
KL 064/02
90x25 mm



Fig. 3
KL 064/03
75x25 mm



Fig. 4
KL 064/04
60x22 mm



Fig. 5
KL 064/05
25x20 mm

AA AB AC AD AE AF AG AH AI AJ AK AL AM AN AO AP AQ AR AS AT AU AV AW AX AY AZ
BA BB BC BD BE BF BG BH BI BJ BK BL BM BN BO BP BQ BR BS BT BU BV BW BX BY BZ
CA CB CC CD CE CF CG CH CI CJ CK CL CM CN CO CP CQ CR CS CT CU CV CW CX CY CZ
DA DB DC DD DE DF DG DH DI DJ DK DL DM DN DO DP DQ DR DS DT DU DV DW DX DY DZ
EA EB EC ED EE EF EG EH EI EJ EK EL EM EN EO EP EQ ER ES ET EU EV EW EX EY EZ
FA FB FC FD FE FF FG FH FI FJ FK FL FM FN FO FP FQ FR FS FT FU FV FW FX FY FZ
GA GB GC GD GE GF GG GH GI GJ GK GL GM GN GO GP GQ GR GS GT GU GV GW GX GY GZ
HA HB HC HD HE HF HG HH HI HJ HK HL HM HN HO HP HQ HR HS HT HU HV HW HX HY HZ
IA IB IC ID IE IF IG IH II IJ IK IL IM IN IO IP IQ IR IS IT IU IV IW IX IY IZ
JA JB JC JD JE JF JG JH JI JJ JK JL JM JN JO JP JQ JR JS JT JU JV JW JX JY JZ
KA KB KC KD KE KF KG KH KI KJ KL KM KN KO KP KQ KR KS KT KU KV KW KX KY KZ
LA LB LC LD LE LF LG LH LI LJ LK LL LM LN LO LP LQ LR LS LT LU LV LW LX LY LZ
MA MB MC MD ME MF MG MH MI MJ MK ML MN MO MP MQ MR MS MT MU MV MW MX MY MZ
NA NB NC ND NE NF NG NH NI NJ NK NL NN NO NP NQ NR NS NT NU NV NW NX NY NZ
OA OB OC OD OE OF OG OH OI OJ OK OL OM ON OO OP OQ OR OS OT OU OV OW OX OY OZ
PA PB PC PD PE PF PG PH PI PJ PK PL PM PN PO PP PQ PR PS PT PU PV PW PX PY PZ
QA QB QC QD QE QF QG QH QI QJ QK QL QM QN QO QQ QR QS QT QU QV QW QX QY QZ
RA RB RC RD RE RF RG RH RI RJ RK RL RM RN RO RP RQ RR RS RT RU RV RW RX RY RZ
SA SB SC SD SE SF SG SH SI SJ SK SL SM SN SO SP SQ SR SS ST SU SV SW SX SY SZ
TA TB TC TD TE TF TG TH TI TJ TK TL TM TN TO TP TQ TR TS TT TU TV TW TX TY TZ
UA UB UC UD UE UF UG UH UI UJ UK UL UM UN UO UP UQ UR US UT UU UV UW UX UY UZ
VA VB VC VD VE VF VG VH VI VJ VK VL VM VN VO VP VQ VR VS VT VU VW VX VY VZ
WA WB WC WD WE WF WG WH WI WJ WK WL WM WN WO WP WQ WR WS WT WU WV WW WX WY WZ
XA XB XC XD XE XF XG XH XI XJ XK XL XM XN XO XP XQ XR XS XT XU XV XW XX XY XZ
YA YB YC YD YE YF YG YH YI YJ YK YL YM YN YO YP YQ YR YS YT YU YV YW YX YY YZ
ZA ZB ZC ZD ZE ZF ZG ZH ZI ZJ ZK ZL ZM ZN ZO ZP ZQ ZR ZS ZT ZU ZV ZW ZX ZY ZZ

Mundsperrer
 Mouth Gags
 Abre-bocas
 Ouvre-bouches
 Apribocca



KL 066/04
 Sperrer alleine
 Gag only
 Abre-boca suelto
 Ouvre-bouche seul
 Apribocca solo

**MC
 IVOR**
 KL 066/00
 komplett
 complete
 completo
 complet
 completo



Fig. 1
 KL 066/01
 95x27 mm



Fig. 2
 KL 066/02
 85x22 mm



Fig. 3
 KL 066/03
 70x22 mm



MODELL WÜRZBURG

Fig.		
1	66x28 mm	KL 068/01
2	75x32 mm	KL 068/02
3	83x34 mm	KL 068/03
4	93x37 mm	KL 068/04
5	100x38 mm	KL 068/05



NEGUS
 KL 072/00

ZUNGE TONGUE LENGUA LANGUE LINGUA

Mundkeile
 Oral Wedges
 Garrotes
 Baillons
 Apribocca

für Erwachsene
 for adults
 para adultos
 pour adultes
 per adulti

für Kinder
 for children
 para niños
 pour enfants
 per bambini



1/2

McKESSON
 KL 080/00-04



KL 080/00



KL 080/03



KL 080/01



KL 080/04



KL 080/02



1/2

McKESSON
 KL 082/01-04



KL 082/01



KL 082/03



KL 082/02



KL 082/04

AA AB AC AD AE AF AG AH AI AJ AK AL AM AN AO AP AQ AR AS AT AU AV AW AX AY AZ
 BA BB BC BD BE BF BG BH BI BJ BK BL BM BN BO BP BQ BR BS BT BU BV BW BX BY BZ
 CA CB CC CD CE CF CG CH CI CJ CK CL CM CN CO CP CQ CR CS CT CU CV CW CX CY CZ
 DA DB DC DD DE DF DG DH DI DJ DK DL DM DN DO DP DQ DR DS DT DU DV DW DX DY DZ
 EA EB EC ED EE EF EG EH EI EJ EK EL EM EN EO EP EQ ER ES ET EU EV EW EX EY EZ
 FA FB FC FD FE FF FG FH FI FJ FK FL FM FN FO FP FQ FR FS FT FU FV FW FX FY FZ
 GA GB GC GD GE GF GG GH GI GJ GK GL GM GN GO GP GQ GR GS GT GU GV GW GX GY GZ
 HA HB HC HD HE HF HG HH HI HJ HK HL HM HN HO HP HQ HR HS HT HU HV HW HX HY HZ
 IA IB IC ID IE IF IG IH II IJ IK IL IM IN IO IP IQ IR IS IT IU IV IW IX IY IZ
 JA JB JC JD JE JF JG JH JI JJ JK JL JM JN JO JP JQ JR JS JT JU JV JW JX JY JZ
 KA KB KC KD KE KF KG KH KI KJ KK KL KM KN KO KP KQ KR KS KT KU KV KW KX KY KZ
 LA LB LC LD LE LF LG LH LI LJ LK LL LM LN LO LP LQ LR LS LT LU LV LW LX LY LZ
 MA MB MC MD ME MF MG MH MI MJ MK ML MN MO MP MQ MR MS MT MU MV MW MX MY MZ
 NA NB NC ND NE NF NG NH NI NJ NK NL NM NO NP NQ NR NS NT NU NV NW NX NY NZ
 OA OB OC OD OE OF OG OH OI OJ OK OL OM ON OO OP OQ OR OS OT OU OV OW OX OY OZ
 PA PB PC PD PE PF PG PH PI PJ PK PL PM PN PO PP PQ PR PS PT PU PV PW PX PY PZ
 QA QB QC QD QE QF QG QH QI QJ QK QL QM QN QO QP QQ QR QS QT QU QV QW QX QY QZ
 RA RB RC RD RE RF RG RH RI RJ RK RL RM RN RO RP RQ RR RS RT RU RV RW RX RY RZ
 SA SB SC SD SE SF SG SH SI SJ SK SL SM SN SO SP SQ SR SS ST SU SV SW SX SY SZ
 TA TB TC TD TE TF TG TH TI TJ TK TL TM TN TO TP TQ TR TS TT TU TV TW TX TY TZ
 UA UB UC UD UE UF UG UH UI UJ UK UL UM UN UO UP UQ UR US UT UU UV UW UX UY UZ
 VA VB VC VD VE VF VG VH VI VJ VK VL VM VN VO VP VQ VR VS VT VU VV VW VX VY VZ
 WA WB WC WD WE WF WG WH WI WJ WK WL WM WN WO WP WQ WR WS WT WU WV WW WX WY WZ
 XA XB XC XD XE XF XG XH XI XJ XK XL XM XN XO XP XQ XR XS XT XU XV XW XX XY XZ
 YA YB YC YD YE YF YG YH YI YJ YK YL YM YN YO YP YQ YR YS YT YU YV YW YX YY YZ
 ZA ZB ZC ZD ZE ZF ZG ZH ZI ZJ ZK ZL ZM ZN ZO ZP ZQ ZR ZS ZT ZU ZV ZW ZX ZY ZZ

KL ZUNGE TONGUE LENGUA LANGUE LINGUA

Wangen- und Lippenhalter, Zungendrücker
 Cheek and Lip Retractors, Tongue Depressors
 Separadores para mejillas y labios, Abaja-lenguas
 Ecarteurs des joues et des lèvres, Abaisse-langues
 Divaricatori per guancia e labbra, Abbassalingua



SIMPLEX
 KL 100/11
 11,0 cm/4¹/₃"



STERNBERG
 KL 105/12 = 12,0 cm/4³/₄"
 KL 105/14 = 14,0 cm/5¹/₂"
 KL 105/16 = 16,0 cm/6¹/₄"



TOBOLD
 KL 112/14
 14,5 cm/5³/₄"



HARTMANN
 KL 114/15
 15,0 cm/6"



MORITZ-SCHMIDT
 KL 116/19
 19,0 cm/7¹/₂"



WIEDER
 14,5 cm/5³/₄"



KL 120/14
 28 mm



KL 120/15
 32 mm

ZUNGE TONGUE LENGUA LANGUE LINGUA

Wangen- und Lippenhalter, Zungendrucker
 Cheek and Lip Retractors, Tongue Depressors
 Separadores para mejillas y labios, Abaja-lenguas
 Ecarteurs des joues et des lèvres, Abaisse-langues
 Divaricatori per guancie e labbra, Abbassalingua



KL 122/19
 19,0 cm/7¹/₂"



STANDARD
 KL 124/14
 14,5 cm/5³/₄"



UNIV. MINNESOTA
 KL 125/14
 14,0 cm/5¹/₂"



KROENIG
 KL 126/15
 15,0 cm/6"



MAYO
 KL 128/17
 17,0 cm/6³/₄"



BRUENINGS
 KL 130/19
 19,0 cm/7¹/₂"



FRENZEL
 KL 131/16
 16,5 cm/6¹/₂"



KL 132/18
 18,0 cm/7"

AA AB AC AD AE AF AG AH AI AJ AK AL AM AN AO AP AQ AR AS AT AU AV AW AX AY AZ
 BA BB BC BD BE BF BG BH BI BJ BK BL BM BN BO BP BQ BR BS BT BU BV BW BX BY BZ
 CA CB CC CD CE CF CG CH CI CJ CK CL CM CN CO CP CQ CR CS CT CU CV CW CX CY CZ
 DA DB DC DD DE DF DG DH DI DJ DK DL DM DN DO DP DQ DR DS DT DU DV DW DX DY DZ
 EA EB EC ED EE EF EG EH EI EJ EK EL EM EN EO EP EQ ER ES ET EU EV EW EX EY EZ
 FA FB FC FD FE FF FG FH FI FJ FK FL FM FN FO FP FQ FR FS FT FU FV FW FX FY FZ
 GA GB GC GD GE GF GG GH GI GJ GK GL GM GN GO GP GQ GR GS GT GU GV GW GX GY GZ
 HA HB HC HD HE HF HG HH HI HJ HK HL HM HN HO HP HQ HR HS HT HU HV HW HX HY HZ
 IA IB IC ID IE IF IG IH II IJ IK IL IM IN IO IP IQ IR IS IT IU IV IW IX IY IZ
 JA JB JC JD JE JF JG JH JI JJ JK JL JM JN JO JP JQ JR JS JT JU JV JW JX JY JZ
 KA KB KC KD KE KF KG KH KI KJ KK KL KM KN KO KP KQ KR KS KT KU KV KW KX KY KZ
 LA LB LC LD LE LF LG LH LI LJ LK LL LM LN LO LP LQ LR LS LT LU LV LW LX LY LZ
 MA MB MC MD ME MF MG MH MI MJ MK ML MN MO MP MQ MR MS MT MU MV MW MX MY MZ
 NA NB NC ND NE NF NG NH NI NJ NK NL NM NO NP NQ NR NS NT NU NV NW NX NY NZ
 OA OB OC OD OE OF OG OH OI OJ OK OL OM ON OO OP OQ OR OS OT OU OV OW OX OY OZ
 PA PB PC PD PE PF PG PH PI PJ PK PL PM PN PO PP PQ PR PS PT PU PV PW PX PY PZ
 QA QB QC QD QE QF QG QH QI QJ QK QL QM QN QO QQ QR QS QT QU QV QW QX QY QZ
 RA RB RC RD RE RF RG RH RI RJ RK RL RM RN RO RP RQ RR RS RT RU RV RW RX RY RZ
 SA SB SC SD SE SF SG SH SI SJ SK SL SM SN SO SP SQ SR SS ST SU SV SW SX SY SZ
 TA TB TC TD TE TF TG TH TI TJ TK TL TM TN TO TP TQ TR TS TT TU TV TW TX TY TZ
 UA UB UC UD UE UF UG UH UI UJ UK UL UM UN UO UP UQ UR US UT UU UV UW UX UY UZ
 VA VB VC VD VE VF VG VH VI VJ VK VL VM VN VO VP VQ VR VS VT VU VV VW VX VY VZ
 WA WB WC WD WE WF WG WH WI WJ WK WL WM WN WO WP WQ WR WS WT WU WV WW WX WY WZ
 XA XB XC XD XE XF XG XH XI XJ XK XL XM XN XO XP XQ XR XS XT XU XV XW XX XY XZ
 YA YB YC YD YE YF YG YH YI YJ YK YL YM YN YO YP YQ YR YS YT YU YV YW YX YY YZ
 ZA ZB ZC ZD ZE ZF ZG ZH ZI ZJ ZK ZL ZM ZN ZO ZP ZQ ZR ZS ZT ZU ZV ZW ZX ZY ZZ

KL ZUNGE TONGUE LENGUA LANGUE LINGUA

Zungenzangen, Dissektoren, Tamponstopfer
 Tongue Holding Forceps, Dissectors, Gauze packers
 Pinzas tira-lengua, Disecadores, Taponeadores
 Pincés tire-langue, Dissecteurs, Porte-tampon
 Pinze tiralingua, Dissettori, Tamponatori



COLLIN
 KL 140/16
 16,0 cm/6¹/₄"



KL 144/99
 Paar
 pair
 par
 pairé
 paio

YOUNG
 KL 144/17
 17,0 cm/6³/₄"



LUNIATSCHECK
 KL 262/19
 19,0 cm/7¹/₂"

MUND MOUTH BOCA BOUCHE BOCCA

Mundspiegelgriffe
 Mouth mirror handles
 Mangos para espejos de boca
 Manches pour miroirs à bouche
 Manici per specchietti



SECCO
 KL 506/01
 14,0 cm/5 1/2"



KL 507/12
 12,0 cm/4 3/4"



KL 508/12
 12,0 cm/4 3/4"
 Ø 6 mm



KL 509/14
 14,0 cm/5 1/2"
 Ø 8 mm



KL 509/24
 14,0 cm/5 1/2"
 Ø 11 mm



KL 510/12
 12,0 cm/4 3/4"

AA
 AB
 AC
 AD
 AE
 AF
 AK
 AL
 AO
 AR
 KA
KL
 KU
 PA
 PB
 PF
 PI
 PK
 PL
 PM
 PP
 PS
 PT
 PU
 PV
 KYE

Mundspiegelansätze
 Mouth mirrors
 Espejos de boca
 Mirrors à bouche
 Specchietti



HILGER
 KL 513/02

Verpackungseinheit / packing unit 12 St./pc.

Größe	plan, metr. Gewinde	metr. Gewinde, hohl
Size	plane, metr. thread	metr. thread, concave
Tamaño	plano, rosca métrica	rosca métrica, cóncavo
Taille	plan, filetage métrique	filetage métrique, concave
Dimens.	piano, filettatura metrica	filettatura metrica, cavo

Ø mm			
22	4	KL 511/04	KL 512/04
24	5	KL 511/05	KL 512/05

VERSCHIEDENES
VARIOUS ITEMS
DIVERSOS ARTICULOS
ARTICLES DIVERS
ARTICOLI DIVERSI

KU

nopa[®] instruments





KU 295/01
Ø 130 mm

KU 295/02
Ø 130 mm

Weichgummi
soft rubber
goma blanda
caoutchouc mou
gomma morbida

Kunststoff
plastic
plástico
plastique
plastica



Ø x h		
40 x 19 mm	0,05 l	KU 300/04
61 x 30 mm	0,07 l	KU 300/06
80 x 40 mm	0,14 l	KU 300/08
116 x 50 mm	0,35 l	KU 300/11
128 x 55 mm	0,45 l	KU 300/12
147 x 65 mm	0,70 l	KU 300/14



KU 301/01 = 0,25 l
KU 301/02 = 0,50 l
KU 301/03 = 1,00 l
KU 301/04 = 2,00 l

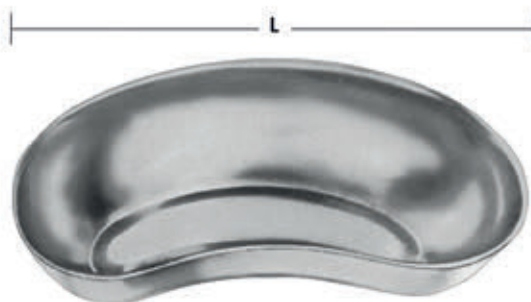

L = 170 mm	KU 302/17
L = 250 mm	KU 302/25
L = 275 mm	KU 302/27



KU 303/65 →

KU 303/00
Ø = 65 mm

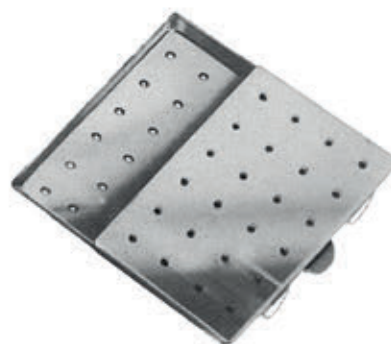

KU 304/50 = 50 x 25 x 4,5 mm
KU 304/65 = 65 x 42 x 8,0 mm
KU 304/75 = 75 x 25 x 4,5 mm



KU 306/15 = 150 x 95 x 13 mm



l x b x h	
230 x 155 x 30 mm	KU 307/23
300 x 175 x 30 mm	KU 307/30
300 x 175 x 40 mm	KU 308/30
350 x 240 x 36 mm	KU 308/35
400 x 300 x 50 mm	KU 308/50



l x b x h	
210 x 160 x 10 mm	KU 309/21
240 x 180 x 10 mm	KU 309/24
310 x 150 x 10 mm	KU 309/31
310 x 210 x 10 mm	KU 310/31
350 x 240 x 10 mm	KU 310/35
400 x 270 x 20 mm	KU 310/40
420 x 280 x 10 mm	KU 310/42



Ø x h	l	
165 x 60 mm	0,75	KU 311/16
175 x 70 mm	1,00	KU 311/17
220 x 80 mm	2,00	KU 311/22
225 x 90 mm	2,50	KU 311/23
240 x 110 mm	3,00	KU 311/24
275 x 115 mm	4,50	KU 311/27
290 x 125 mm	6,00	KU 311/29
310 x 120 mm	6,00	KU 311/31
345 x 125 mm	8,50	KU 311/34
380 x 130 mm	11,00	KU 311/38



l x b x h	
16,5 x 9,0 x 3,5 cm	KU 312/16
20,0 x 10,0 x 5,0 cm	KU 312/20
22,0 x 15,0 x 5,0 cm	KU 312/22
26,0 x 15,0 x 5,0 cm	KU 312/26
30,5 x 20,5 x 5,0 cm	KU 312/30



Ø x h	
30 x 90 mm	KU 314/09
50 x 100 mm	KU 314/10
50 x 130 mm	KU 314/13
50 x 175 mm	KU 314/17
75 x 100 mm	KU 315/10
75 x 130 mm	KU 315/13
75 x 175 mm	KU 315/17



ADAMS
KU 317/01



MAYO
KU 318/14
14,0 cm/5 1/2"



MAYO
KU 320/14
14,0 cm/5 1/2"



CHEATLE
KU 321/27
27,0 cm/10 3/4"



ROGGE
KU 322/23
23,0 cm/9"



PYE-SMITH (HARRISON)
KU 323/25 25,0 cm/10"
KU 323/30 30,0 cm/12"

AA AB AC AD AE AF AG AH AI AJ AK AL AM AN AO AP AQ AR AS AT AU AV AW AX AY AZ
BA BB BC BD BE BF BG BH BI BJ BK BL BM BN BO BP BQ BR BS BT BU BV BW BX BY BZ
CA CB CC CD CE CF CG CH CI CJ CK CL CM CN CO CP CQ CR CS CT CU CV CW CX CY CZ
DA DB DC DD DE DF DG DH DI DJ DK DL DM DN DO DP DQ DR DS DT DU DV DW DX DY DZ
EA EB EC ED EE EF EG EH EI EJ EK EL EM EN EO EP EQ ER ES ET EU EV EW EX EY EZ
FA FB FC FD FE FF FG FH FI FJ FK FL FM FN FO FP FQ FR FS FT FU FV FW FX FY FZ
GA GB GC GD GE GF GG GH GI GJ GK GL GM GN GO GP GQ GR GS GT GU GV GW GX GY GZ
HA HB HC HD HE HF HG HH HI HJ HK HL HM HN HO HP HQ HR HS HT HU HV HW HX HY HZ
IA IB IC ID IE IF IG IH II IJ IK IL IM IN IO IP IQ IR IS IT IU IV IW IX IY IZ
JA JB JC JD JE JF JG JH JI JJ JK JL JM JN JO JP JQ JR JS JT JU JV JW JX JY JZ
KA KB KC KD KE KF KG KH KI KJ KL KM KN KO KP KQ KR KS KT KU KV KW KX KY KZ
LA LB LC LD LE LF LG LH LI LJ LK LL LM LN LO LP LQ LR LS LT LU LV LW LX LY LZ
MA MB MC MD ME MF MG MH MI MJ MK ML MN MO MP MQ MR MS MT MU MV MW MX MY MZ
NA NB NC ND NE NF NG NH NI NJ NK NL NM NO NP NQ NR NS NT NU NV NW NX NY NZ
OA OB OC OD OE OF OG OH OI OJ OK OL OM ON OO OP OQ OR OS OT OU OV OW OX OY OZ
PA PB PC PD PE PF PG PH PI PJ PK PL PM PN PO PP PQ PR PS PT PU PV PW PX PY PZ
QA QB QC QD QE QF QG QH QI QJ QK QL QM QN QO QP QQ QR QS QT QU QV QW QX QY QZ
RA RB RC RD RE RF RG RH RI RJ RK RL RM RN RO RP RQ RR RS RT RU RV RW RX RY RZ
SA SB SC SD SE SF SG SH SI SJ SK SL SM SN SO SP SQ SR SS ST SU SV SW SX SY SZ
TA TB TC TD TE TF TG TH TI TJ TK TL TM TN TO TP TQ TR TS TT TU TV TW TX TY TZ
UA UB UC UD UE UF UG UH UI UJ UK UL UM UN UO UP UQ UR US UT UU UV UW UX UY UZ
VA VB VC VD VE VF VG VH VI VJ VK VL VM VN VO VP VQ VR VS VT VU VV VW VX VY VZ
WA WB WC WD WE WF WG WH WI WJ WK WL WM WN WO WP WQ WR WS WT WU WV WW WX WY WZ
XA XB XC XD XE XF XG XH XI XJ XK XL XM XN XO XP XQ XR XS XT XU XV XW XX XY XZ
YA YB YC YD YE YF YG YH YI YJ YK YL YM YN YO YP YQ YR YS YT YU YV YW YX YY YZ
ZA ZB ZC ZD ZE ZF ZG ZH ZI ZJ ZK ZL ZM ZN ZO ZP ZQ ZR ZS ZT ZU ZV ZW ZX ZY ZZ

KU



KU 328/01
50 x 75 mm



KU 329/01
Ø 30,0 mm



KU 329/02
Ø 30,0 mm

Disposable dappen dish
Kunststoff - plastic - plástico - plastique - plastica



KU 332/01
Verpackungseinheit / packing unit 1000 St./pc.
250 pro Farbe / 250 per colour

Glass dappen dish
Glas - glass - cristal - verre - vetro



KU 333/01

KU 333/02

KU 333/03

KU 333/04

Verpackungseinheit / packing unit
2 St. pro Farbe / 2 pcs. per colour

Glas-Anmischplatten / glass mixing slabs

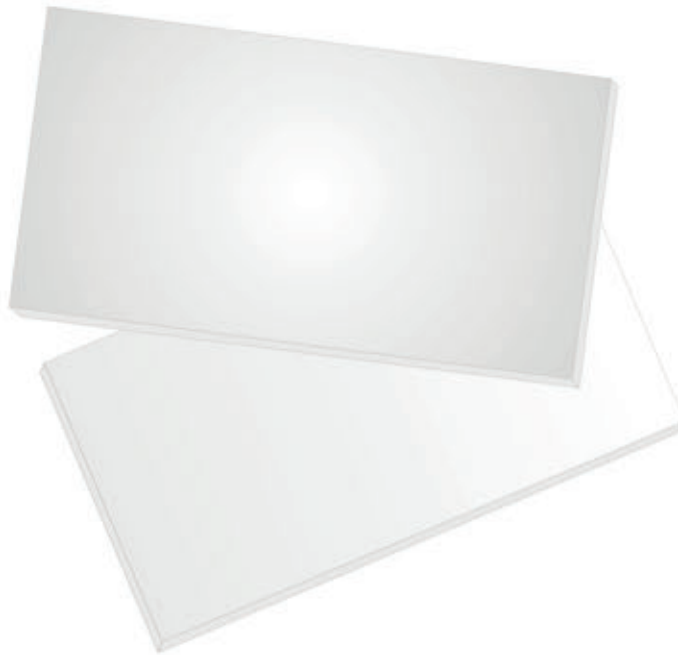

KU 335/02
150 x 80 x 2 mm



KU 340/01
Ø 11,0 mm
15,0 cm/6"



KU 340/02
Ø 11,0 mm
11,0 cm/4 1/3"



KU 340/03
Ø 11,0 mm
14,0 cm/5 1/2"

ZAHNZANGEN
EXTRACTING FORCEPS
FORCEPS DE EXTRACCION
DAVIERS
PINZA PER ESTRAZIONE

PA english pattern

nopa[®] instruments



Zahnzangen, englische Modelle
 Extracting forceps, english pattern
 Fórceps de extracción, forma inglesa
 Daviers, modèle anglaise
 Pinza per estrazione, modello inglese

Einsatzbereiche der Zahnzangen
 Application-Charts for extracting forceps
 Tablas de aplicación para Forceps de extracción
 Tableaux d'application des daviers
 Tabella d'applicazione delle pinze per estrazione

Oberkiefer, Upper jaw, Mandibula Superior, Mâchoire supérieure, Mandibola superiore																
	8	7	6	5	4	3	2	1	1	2	3	4	5	6	7	8
FDI	18	17	16	15	14	13	12	11	21	22	23	24	25	26	27	28
				55	54	53	52	51	61	62	63	64	65			
Milchzähne, Temporary teeth, Dentadura temporaria, Denture temporaire, Denti di latte																

	rechts, right side, lado derecho, côté droit, lato destra	links, left side, lado izquierdo, côté gauche, lato sinistra	
Zahn, Tooth, Diente, Dent, Un Dente		Zahn, Tooth, Diente, Dent, Un Dente	
FDI		FDI	
11 (1)	1, 3, 29, 30 34N, 35N	21 (1)	1, 3, 29, 30, 34N, 35N
51 (1)	29S, 30S, 37, 137	61 (1)	29S, 30S, 37, 137
12 (2)	2, 3, 29, 30, 34N, 35N	22 (2)	2, 3, 29, 30, 34N, 35N
52 (2)	29S, 30S, 37, 137	62 (2)	29S, 30S, 37, 137
13 (3)	1, 3	23 (3)	1, 3
53 (3)	37, 137	63 (3)	37, 137
14 (4)	2, 7, 34N, 35N, 76, 76N	24 (4)	2, 7, 34N, 35N, 76, 76N
54 (4)	39, 39R, 139	64 (4)	39, 39L, 139
15 (5)	2, 7, 34N, 35N, 76, 76N	25 (5)	2, 7, 34N, 35N, 76, 76N
55 (5)	39, 39R, 139	65 (5)	39, 39L, 139
16 (6)	17, 18A, 89	26 (6)	18, 18A, 90
17 (7)	17, 18A, 89	27 (7)	18, 18A, 90
18 (8)	17, 18A, 19, 67, 67A, 67N, 89	28 (8)	18, 18A, 19, 67, 67A, 67N, 90

Wurzeln, Roots, Raíces, Racines, Radici	
11 (1) - 28 (8)	30, 44, 51, 51A, 76, 76N, 97, 146, 51LX, 151, 152, 153
51 (1) - 65 (5)	29S, 30S, 51S

ZAHNZANGEN EXTRACTING FORCEPS FORCEPS DE EXTRACCION DAVIERS PINZA PER ESTRAZIONE

Zahnzangen, englische Modelle
 Extracting forceps, english pattern
 Fórceps de extracción, forma inglesa
 Daviers, modèle anglaise
 Pinza per estrazione, modello inglese

Einsatzbereiche der Zahnzangen
 Application-Charts for extracting forceps
 Tablas de aplicación para Forceps de extracción
 Tableaux d'application des daviers
 Tabella d'applicazione delle pinze per estrazione

Unterkiefer, Lower jaw, Mandibula inferior, Mâchoire inférieure, Mandibola inferiore																
	8	7	6	5	4	3	2	1	1	2	3	4	5	6	7	8
FDI	48	47	46	45	44	43	42	41	31	32	33	34	35	36	37	38
				85	84	83	82	81	71	72	73	74	75			
Milchzähne, Temporary teeth, Dentadura temporaria, Denture temporaire, Denti di latte																

	rechts, right side, lado derecho, côté droit, lato destra	links, left side, lado izquierdo, côté gauche, lato sinistra	
Zahn, Tooth, Diente, Dent, Un Dente		Zahn, Tooth, Diente, Dent, Un Dente	
FDI		FDI	
41 (1)	4, 74, 74N, 74XN	31 (1)	4, 74, 74N, 74XN
81 (1)	5, 38	71 (1)	5, 38
42 (2)	4, 74, 74N, 74XN	32 (2)	4, 74, 74N, 74XN
82 (2)	5, 38	72 (2)	5, 38
43 (3)	4, 75	33 (3)	4, 75
83 (3)	38	73 (3)	38
44 (4)	8, 13, 36N, 46N, 75	34 (4)	8, 13, 36N, 46N, 75
84 (4)	6, 13S, 22S	74 (4)	6, 13S, 22S
45 (5)	8, 13, 36N, 46N, 75	35 (5)	8, 13, 36N, 46N, 75
85 (5)	6, 13S, 22S	75 (5)	6, 13S, 22S
46 (6)	21, 22, 23, 73, 86A, 86B, 86C, 87	36 (6)	21, 22, 24, 73, 86A, 86B, 86C, 87
47 (7)	21, 22, 23, 73, 86A, 86B, 86C, 87	37 (7)	21, 22, 24, 73, 86A, 86B, 86C, 87
48 (8)	79, 79A, 79N	38 (8)	79, 79A, 79N

Wurzeln, Roots, Raíces, Racines, Radici	
31 (1) - 48 (8)	31, 33, 33A, 33M, 46L, 46LX, 74, 74N, 74XN, 146, 151, 152, 153
71 (1) - 85 (5)	7, 33S

AA AB AC AD AE AF AG AH AI AJ AK AL AM AN AO AP AQ AR AS AT AU AV AW AX AY AZ BA BB BC BD BE BF BG BH BI BJ BK BL BM BN BO BP BQ BR BS BT BU BV BW BX BY BZ CA CB CC CD CE CF CG CH CI CJ CK CL CM CN CO CP CQ CR CS CT CU CV CW CX CY CZ DA DB DC DE DF DG DH DI DJ DK DL DM DN DO DP DQ DR DS DT DU DV DW DX DY DZ EA EB EC ED EE EF EG EH EI EJ EK EL EM EN EO EP EQ ER ES ET EU EV EW EX EY EZ FA FB FC FD FE FF FG FH FI FJ FK FL FM FN FO FP FQ FR FS FT FU FV FW FX FY FZ GA GB GC GD GE GF GG GH GI GJ GK GL GM GN GO GP GQ GR GS GT GU GV GW GX GY GZ HA HB HC HD HE HF HG HH HI HJ HK HL HM HN HO HP HQ HR HS HT HU HV HW HX HY HZ IA IB IC ID IE IF IG IH II IJ IK IL IM IN IO IP IQ IR IS IT IU IV IW IX IY IZ JA JB JC JD JE JF JG JH JI JJ JK JL JM JN JO JP JQ JR JS JT JU JV JW JX JY JZ KA KB KC KD KE KF KG KH KI KJ KL KM KN KO KP KQ KR KS KT KU KV KW KX KY KZ LA LB LC LD LE LF LG LH LI LJ LK LL LM LN LO LP LQ LR LS LT LU LV LW LX LY LZ MA MB MC MD ME MF MG MH MI MJ MK ML MN MO MP MQ MR MS MT MU MV MW MX MY MZ NA NB NC ND NE NF NG NH NI NJ NK NL NO NP NQ NR NS NT NU NV NW NX NY NZ OA OB OC OD OE OF OG OH OI OJ OK OL OM ON OO OP OQ OR OS OT OU OV OW OX OY OZ PA PB PC PD PE PF PG PH PI PJ PK PL PM PN PO PP PQ PR PS PT PU PV PW PX PY PZ QA QB QC QD QE QF QG QH QI QJ QK QL QM QN QO QP QQ QR QS QT QU QV QW QX QY QZ RA RB RC RD RE RF RG RH RI RJ RK RL RM RN RO RP RQ RR RS RT RU RV RW RX RY RZ SA SB SC SD SE SF SG SH SI SJ SK SL SM SN SO SP SQ SR SS ST SU SV SW SX SY SZ TA TB TC TD TE TF TG TH TI TJ TK TL TM TN TO TP TQ TR TS TT TU TV TW TX TY TZ UA UB UC UD UE UF UG UH UI UJ UK UL UM UN UO UP UQ UR US UT UY UZ VA VB VC VD VE VF VG VH VI VJ VK VL VM VN VO VP VQ VR VS VT VY VZ WA WB WC WD WE WF WG WH WI WJ WK WL WM WN WO WP WQ WR WS WT WY WZ XA XB XC XD XE XF XG XH XI XJ XK XL XM XN XO XP XQ XR XS XT XU XV XW XX XY XZ YA YB YC YD YE YF YG YH YI YJ YK YL YM YN YO YP YQ YR YS YT YU YV YW YX YY YZ ZA ZB ZC ZD ZE ZF ZG ZH ZI ZJ ZK ZL ZM ZN ZO ZP ZQ ZR ZS ZT ZU ZV ZW ZX ZY ZZ

Zahnzangen, englische Modelle
 Extracting forceps, english pattern
 Fórceps de extracción, forma inglesa
 Daviers, modèle anglaise
 Pinza per estrazione, modello inglese



Fig.1
PA 001/00



Fig.2
PA 002/00



Fig.3
PA 003/00

ZAHNZANGEN EXTRACTING FORCEPS FORCEPS DE EXTRACCION DAVIERS PINZA PER ESTRAZIONE

Zahnzangen, englische Modelle
 Extracting forceps, english pattern
 Fórceps de extracción, forma inglesa
 Daviers, modèle anglaise
 Pinza per estrazione, modello inglese

AA
AB
AC
AD
AE
AF
AK
AL
AO
AR
KA
KL
KU
PA
PB
PF
PI
PK
PL
PM
PP
PS
PT
PU
PV
KYE



Fig.4
PA 004/00



Fig.7
PA 007/00



Fig.8
PA 008/00

Zahnzangen, englische Modelle
 Extracting forceps, english pattern
 Fórceps de extracción, forma inglesa
 Daviers, modèle anglaise
 Pinza per estrazione, modello inglese



Fig.13
 PA 013/00



Fig.17
 PA 017/00

ZAHNZANGEN EXTRACTING FORCEPS FORCEPS DE EXTRACCION DAVIERS PINZA PER ESTRAZIONE

Zahnzangen, englische Modelle
 Extracting forceps, english pattern
 Fórceps de extracción, forma inglesa
 Daviers, modèle anglaise
 Pinza per estrazione, modello inglese



Fig. 18
 PA 018/00



Fig. 18A
 PA 018/01

AA
 AB
 AC
 AD
 AE
 AF
 AG
 AH
 AI
 AJ
 AK
 AL
 AM
 AN
 AO
 AP
 AQ
 AR
 AS
 AT
 AU
 AV
 AW
 AX
 AY
 AZ
 BA
 BB
 BC
 BD
 BE
 BF
 BG
 BH
 BI
 BJ
 BK
 BL
 BM
 BN
 BO
 BP
 BQ
 BR
 BS
 BT
 BU
 BV
 BW
 BX
 BY
 BZ
 CA
 CB
 CC
 CD
 CE
 CF
 CG
 CH
 CI
 CJ
 CK
 CL
 CM
 CN
 CO
 CP
 CQ
 CR
 CS
 CT
 CU
 CV
 CW
 CX
 CY
 CZ
 DA
 DB
 DC
 DD
 DE
 DF
 DG
 DH
 DI
 DJ
 DK
 DL
 DM
 DN
 DO
 DP
 DQ
 DR
 DS
 DT
 DU
 DV
 DW
 DX
 DY
 DZ
 EA
 EB
 EC
 ED
 EE
 EF
 EG
 EH
 EI
 EJ
 EK
 EL
 EM
 EN
 EO
 EP
 EQ
 ER
 ES
 ET
 EU
 EV
 EW
 EX
 EY
 EZ
 FA
 FB
 FC
 FD
 FE
 FF
 FG
 FH
 FI
 FJ
 FK
 FL
 FM
 FN
 FO
 FP
 FQ
 FR
 FS
 FT
 FU
 FV
 FW
 FX
 FY
 FZ
 GA
 GB
 GC
 GD
 GE
 GF
 GG
 GH
 GI
 GJ
 GK
 GL
 GM
 GN
 GO
 GP
 GQ
 GR
 GS
 GT
 GU
 GV
 GW
 GX
 GY
 GZ
 HA
 HB
 HC
 HD
 HE
 HF
 HG
 HH
 HI
 HJ
 HK
 HL
 HM
 HN
 HO
 HP
 HQ
 HR
 HS
 HT
 HU
 HV
 HW
 HX
 HY
 HZ
 IA
 IB
 IC
 ID
 IE
 IF
 IG
 IH
 II
 IJ
 IK
 IL
 IM
 IN
 IO
 IP
 IQ
 IR
 IS
 IT
 IU
 IV
 IW
 IX
 IY
 IZ
 JA
 JB
 JC
 JD
 JE
 JF
 JG
 JH
 JI
 JJ
 JK
 JL
 JM
 JN
 JO
 JP
 JQ
 JR
 JS
 JT
 JU
 JV
 JW
 JX
 JY
 JZ
 KA
 KB
 KC
 KD
 KE
 KF
 KG
 KH
 KI
 KJ
 KK
 KL
 KM
 KN
 KO
 KP
 KQ
 KR
 KS
 KT
 KU
 KV
 KW
 KX
 KY
 KZ
 LA
 LB
 LC
 LD
 LE
 LF
 LG
 LH
 LI
 LJ
 LK
 LL
 LM
 LN
 LO
 LP
 LQ
 LR
 LS
 LT
 LU
 LV
 LW
 LX
 LY
 LZ
 MA
 MB
 MC
 MD
 ME
 MF
 MG
 MH
 MI
 MJ
 MK
 ML
 MM
 MN
 MO
 MP
 MQ
 MR
 MS
 MT
 MU
 MV
 MW
 MX
 MY
 MZ
 NA
 NB
 NC
 ND
 NE
 NF
 NG
 NH
 NI
 NJ
 NK
 NL
 NM
 NN
 NO
 NP
 NQ
 NR
 NS
 NT
 NU
 NV
 NW
 NX
 NY
 NZ
 OA
 OB
 OC
 OD
 OE
 OF
 OG
 OH
 OI
 OJ
 OK
 OL
 OM
 ON
 OO
 OP
 OQ
 OR
 OS
 OT
 OU
 OV
 OW
 OX
 OY
 OZ
 PA
 PB
 PC
 PD
 PE
 PF
 PG
 PH
 PI
 PJ
 PK
 PL
 PM
 PN
 PO
 PP
 PQ
 PR
 PS
 PT
 PU
 PV
 PW
 PX
 PY
 PZ
 QA
 QB
 QC
 QD
 QE
 QF
 QG
 QH
 QI
 QJ
 QK
 QL
 QM
 QN
 QO
 QP
 QQ
 QR
 QS
 QT
 QU
 QV
 QW
 QX
 QY
 QZ
 RA
 RB
 RC
 RD
 RE
 RF
 RG
 RH
 RI
 RJ
 RK
 RL
 RM
 RN
 RO
 RP
 RQ
 RR
 RS
 RT
 RU
 RV
 RW
 RX
 RY
 RZ
 SA
 SB
 SC
 SD
 SE
 SF
 SG
 SH
 SI
 SJ
 SK
 SL
 SM
 SN
 SO
 SP
 SQ
 SR
 SS
 ST
 SU
 SV
 SW
 SX
 SY
 SZ
 TA
 TB
 TC
 TD
 TE
 TF
 TG
 TH
 TI
 TJ
 TK
 TL
 TM
 TN
 TO
 TP
 TQ
 TR
 TS
 TT
 TU
 TV
 TW
 TX
 TY
 TZ
 UA
 UB
 UC
 UD
 UE
 UF
 UG
 UH
 UI
 UJ
 UK
 UL
 UM
 UN
 UO
 UP
 UQ
 UR
 US
 UT
 UU
 UV
 UW
 UX
 UY
 UZ
 VA
 VB
 VC
 VD
 VE
 VF
 VG
 VH
 VI
 VJ
 VK
 VL
 VM
 VN
 VO
 VP
 VQ
 VR
 VS
 VT
 VU
 VV
 VW
 VX
 VY
 VZ
 WA
 WB
 WC
 WD
 WE
 WF
 WG
 WH
 WI
 WJ
 WK
 WL
 WM
 WN
 WO
 WP
 WQ
 WR
 WS
 WT
 WU
 WV
 WW
 WX
 WY
 WZ
 XA
 XB
 XC
 XD
 XE
 XF
 XG
 XH
 XI
 XJ
 XK
 XL
 XM
 XN
 XO
 XP
 XQ
 XR
 XS
 XT
 XU
 XV
 XW
 XX
 XY
 XZ
 YA
 YB
 YC
 YD
 YE
 YF
 YG
 YH
 YI
 YJ
 YK
 YL
 YM
 YN
 YO
 YP
 YQ
 YR
 YS
 YT
 YU
 YV
 YW
 YX
 YY
 YZ
 ZA
 ZB
 ZC
 ZD
 ZE
 ZF
 ZG
 ZH
 ZI
 ZJ
 ZK
 ZL
 ZM
 ZN
 ZO
 ZP
 ZQ
 ZR
 ZS
 ZT
 ZU
 ZV
 ZW
 ZX
 ZY
 ZZ

Zahnzangen, englische Modelle
 Extracting forceps, english pattern
 Fórceps de extracción, forma inglesa
 Daviers, modèle anglaise
 Pinza per estrazione, modello inglese



Fig.19
 PA 019/00



Fig.21
 PA 021/00



Fig.22
 PA 022/00

ZAHNZANGEN EXTRACTING FORCEPS FORCEPS DE EXTRACCION DAVIERS PINZA PER ESTRAZIONE

Zahnzangen, englische Modelle
 Extracting forceps, english pattern
 Fórceps de extracción, forma inglesa
 Daviers, modèle anglaise
 Pinza per estrazione, modello inglese

AA
AB
AC
AD
AE
AF
AK
AL
AO
AR
KA
KL
KU
PA
PB
PF
PI
PK
PL
PM
PP
PS
PT
PU
PV
KYE



Fig.23
PA 023/00



Fig.24
PA 024/00



Fig.29
PA 029/00

Zahnzangen, englische Modelle
 Extracting forceps, english pattern
 Fórceps de extracción, forma inglesa
 Daviers, modèle anglaise
 Pinza per estrazione, modello inglese



Fig.30
 PA 030/00



Fig.31
 PA 031/00

ZAHNZANGEN EXTRACTING FORCEPS FORCEPS DE EXTRACCION DAVIERS PINZA PER ESTRAZIONE

Zahnzangen, englische Modelle
 Extracting forceps, english pattern
 Fórceps de extracción, forma inglesa
 Daviers, modèle anglaise
 Pinza per estrazione, modello inglese



Fig. 33
 PA 033/00



Fig. 33A
 PA 033/01



Fig. 33M
 PA 033/06

AA
 AB
 AC
 AD
 AE
 AF
 AK
 AL
 AO
 AR
 KA
 KL
 KU
 PA
 PB
 PF
 PI
 PK
 PL
 PM
 PP
 PS
 PT
 PU
 PV
 KYE

Zahnzangen, englische Modelle
 Extracting forceps, english pattern
 Fórceps de extracción, forma inglesa
 Daviers, modèle anglaise
 Pinza per estrazione, modello inglese



Fig.34N
 PA 034/00



Fig.35N
 PA 035/00

ZAHNZANGEN EXTRACTING FORCEPS FORCEPS DE EXTRACCION DAVIERS PINZA PER ESTRAZIONE

Zahnzangen, englische Modelle
 Extracting forceps, english pattern
 Fórceps de extracción, forma inglesa
 Daviers, modèle anglaise
 Pinza per estrazione, modello inglese



Fig.36N
 PA 036/00



Fig.44
 PA 044/00

AA
 AB
 AC
 AD
 AE
 AF
 AK
 AL
 AO
 AR
 KA
 KL
 KU
 PA
 PB
 PF
 PI
 PK
 PL
 PM
 PP
 PS
 PT
 PU
 PV
 KYE

Zahnzangen, englische Modelle
 Extracting forceps, english pattern
 Fórceps de extracción, forma inglesa
 Daviers, modèle anglaise
 Pinza per estrazione, modello inglese



Fig.46N
 PA 046/00

Fig.46L
 PA 046/01

Fig.46LX
 PA 046/02

ZAHNZANGEN EXTRACTING FORCEPS FORCEPS DE EXTRACCION DAVIERS PINZA PER ESTRAZIONE

Zahnzangen, englische Modelle
 Extracting forceps, english pattern
 Fórceps de extracción, forma inglesa
 Daviers, modèle anglaise
 Pinza per estrazione, modello inglese



Fig. 51
 PA 051/00



Fig. 51A
 PA 051/01



Fig. 51LX
 PA 051/07

AA
 AB
 AC
 AD
 AE
 AF
 AG
 AH
 AI
 AJ
 AK
 AL
 AO
 AP
 AR
 AS
 AT
 AU
 AV
 AW
 AX
 AY
 AZ
 BA
 BB
 BC
 BD
 BE
 BF
 BG
 BH
 BI
 BJ
 BK
 BL
 BM
 BN
 BO
 BP
 BQ
 BR
 BS
 BT
 BU
 BV
 BW
 BX
 BY
 BZ
 CA
 CB
 CC
 CD
 CE
 CF
 CG
 CH
 CI
 CJ
 CK
 CL
 CM
 CN
 CO
 CP
 CQ
 CR
 CS
 CT
 CU
 CV
 CW
 CX
 CY
 CZ
 DA
 DB
 DC
 DD
 DE
 DF
 DG
 DH
 DI
 DJ
 DK
 DL
 DM
 DN
 DO
 DP
 DQ
 DR
 DS
 DT
 DU
 DV
 DW
 DX
 DY
 DZ
 EA
 EB
 EC
 ED
 EE
 EF
 EG
 EH
 EI
 EJ
 EK
 EL
 EM
 EN
 EO
 EP
 EQ
 ER
 ES
 ET
 EU
 EV
 EW
 EX
 EY
 EZ
 FA
 FB
 FC
 FD
 FE
 FF
 FG
 FH
 FI
 FJ
 FK
 FL
 FM
 FN
 FO
 FP
 FQ
 FR
 FS
 FT
 FU
 FV
 FW
 FX
 FY
 FZ
 GA
 GB
 GC
 GD
 GE
 GF
 GG
 GH
 GI
 GJ
 GK
 GL
 GM
 GN
 GO
 GP
 GQ
 GR
 GS
 GT
 GU
 GV
 GW
 GX
 GY
 GZ
 HA
 HB
 HC
 HD
 HE
 HF
 HG
 HH
 HI
 HJ
 HK
 HL
 HM
 HN
 HO
 HP
 HQ
 HR
 HS
 HT
 HU
 HV
 HW
 HX
 HY
 HZ
 IA
 IB
 IC
 ID
 IE
 IF
 IG
 IH
 II
 IJ
 IK
 IL
 IM
 IN
 IO
 IP
 IQ
 IR
 IS
 IT
 IU
 IV
 IW
 IX
 IY
 IZ
 JA
 JB
 JC
 JD
 JE
 JF
 JG
 JH
 JI
 JJ
 JK
 JL
 JM
 JN
 JO
 JP
 JQ
 JR
 JS
 JT
 JU
 JV
 JW
 JX
 JY
 JZ
 KA
 KB
 KC
 KD
 KE
 KF
 KG
 KH
 KI
 KJ
 KK
 KL
 KM
 KN
 KO
 KP
 KQ
 KR
 KS
 KT
 KU
 KV
 KW
 KX
 KY
 KZ
 LA
 LB
 LC
 LD
 LE
 LF
 LG
 LH
 LI
 LJ
 LK
 LL
 LM
 LN
 LO
 LP
 LQ
 LR
 LS
 LT
 LU
 LV
 LW
 LX
 LY
 LZ
 MA
 MB
 MC
 MD
 ME
 MF
 MG
 MH
 MI
 MJ
 MK
 ML
 MM
 MN
 MO
 MP
 MQ
 MR
 MS
 MT
 MU
 MV
 MW
 MX
 MY
 MZ
 NA
 NB
 NC
 ND
 NE
 NF
 NG
 NH
 NI
 NJ
 NK
 NL
 NM
 NN
 NO
 NP
 NQ
 NR
 NS
 NT
 NU
 NV
 NW
 NX
 NY
 NZ
 OA
 OB
 OC
 OD
 OE
 OF
 OG
 OH
 OI
 OJ
 OK
 OL
 OM
 ON
 OO
 OP
 OQ
 OR
 OS
 OT
 OU
 OV
 OW
 OX
 OY
 OZ
 PA
 PB
 PC
 PD
 PE
 PF
 PG
 PH
 PI
 PJ
 PK
 PL
 PM
 PN
 PO
 PP
 PQ
 PR
 PS
 PT
 PU
 PV
 PW
 PX
 PY
 PZ
 QA
 QB
 QC
 QD
 QE
 QF
 QG
 QH
 QI
 QJ
 QK
 QL
 QM
 QN
 QO
 QP
 QQ
 QR
 QS
 QT
 QU
 QV
 QW
 QX
 QY
 QZ
 RA
 RB
 RC
 RD
 RE
 RF
 RG
 RH
 RI
 RJ
 RK
 RL
 RM
 RN
 RO
 RP
 RQ
 RR
 RS
 RT
 RU
 RV
 RW
 RX
 RY
 RZ
 SA
 SB
 SC
 SD
 SE
 SF
 SG
 SH
 SI
 SJ
 SK
 SL
 SM
 SN
 SO
 SP
 SQ
 SR
 SS
 ST
 SU
 SV
 SW
 SX
 SY
 SZ
 TA
 TB
 TC
 TD
 TE
 TF
 TG
 TH
 TI
 TJ
 TK
 TL
 TM
 TN
 TO
 TP
 TQ
 TR
 TS
 TT
 TU
 TV
 TW
 TX
 TY
 TZ
 UA
 UB
 UC
 UD
 UE
 UF
 UG
 UH
 UI
 UJ
 UK
 UL
 UM
 UN
 UO
 UP
 UQ
 UR
 US
 UT
 UU
 UV
 UW
 UX
 UY
 UZ
 VA
 VB
 VC
 VD
 VE
 VF
 VG
 VH
 VI
 VJ
 VK
 VL
 VM
 VN
 VO
 VP
 VQ
 VR
 VS
 VT
 VU
 VV
 VW
 VX
 VY
 VZ
 WA
 WB
 WC
 WD
 WE
 WF
 WG
 WH
 WI
 WJ
 WK
 WL
 WM
 WN
 WO
 WP
 WQ
 WR
 WS
 WT
 WU
 WV
 WW
 WX
 WY
 WZ
 XA
 XB
 XC
 XD
 XE
 XF
 XG
 XH
 XI
 XJ
 XK
 XL
 XM
 XN
 XO
 XP
 XQ
 XR
 XS
 XT
 XU
 XV
 XW
 XX
 XY
 XZ
 YA
 YB
 YC
 YD
 YE
 YF
 YG
 YH
 YI
 YJ
 YK
 YL
 YM
 YN
 YO
 YP
 YQ
 YR
 YS
 YT
 YU
 YV
 YW
 YX
 YY
 YZ
 ZA
 ZB
 ZC
 ZD
 ZE
 ZF
 ZG
 ZH
 ZI
 ZJ
 ZK
 ZL
 ZM
 ZN
 ZO
 ZP
 ZQ
 ZR
 ZS
 ZT
 ZU
 ZV
 ZW
 ZX
 ZY
 ZZ

Zahnzangen, englische Modelle
 Extracting forceps, english pattern
 Fórceps de extracción, forma inglesa
 Daviers, modèle anglaise
 Pinza per estrazione, modello inglese



Fig. 67
 PA 067/00



Fig. 67A
 PA 067/01



Fig. 67N
 PA 067/02

ZAHNZANGEN EXTRACTING FORCEPS FORCEPS DE EXTRACCION DAVIERS PINZA PER ESTRAZIONE

Zahnzangen, englische Modelle
 Extracting forceps, english pattern
 Fórceps de extracción, forma inglesa
 Daviers, modèle anglaise
 Pinza per estrazione, modello inglese



Fig.73
 PA 073/00



Fig.74
 PA 074/00

AA
 AB
 AC
 AD
 AE
 AF
 AG
 AH
 AI
 AJ
 AK
 AL
 AO
 AP
 AQ
 AR
 AS
 AT
 AU
 AV
 AW
 AX
 AY
 AZ
 BA
 BB
 BC
 BD
 BE
 BF
 BG
 BH
 BI
 BJ
 BK
 BL
 BM
 BN
 BO
 BP
 BQ
 BR
 BS
 BT
 BU
 BV
 BW
 BX
 BY
 BZ
 CA
 CB
 CC
 CD
 CE
 CF
 CG
 CH
 CI
 CJ
 CK
 CL
 CM
 CN
 CO
 CP
 CQ
 CR
 CS
 CT
 CU
 CV
 CW
 CX
 CY
 CZ
 DA
 DB
 DC
 DD
 DE
 DF
 DG
 DH
 DI
 DJ
 DK
 DL
 DM
 DN
 DO
 DP
 DQ
 DR
 DS
 DT
 DU
 DV
 DW
 DX
 DY
 DZ
 EA
 EB
 EC
 ED
 EE
 EF
 EG
 EH
 EI
 EJ
 EK
 EL
 EM
 EN
 EO
 EP
 EQ
 ER
 ES
 ET
 EU
 EV
 EW
 EX
 EY
 EZ
 FA
 FB
 FC
 FD
 FE
 FF
 FG
 FH
 FI
 FJ
 FK
 FL
 FM
 FN
 FO
 FP
 FQ
 FR
 FS
 FT
 FU
 FV
 FW
 FX
 FY
 FZ
 GA
 GB
 GC
 GD
 GE
 GF
 GG
 GH
 GI
 GJ
 GK
 GL
 GM
 GN
 GO
 GP
 GQ
 GR
 GS
 GT
 GU
 GV
 GW
 GX
 GY
 GZ
 HA
 HB
 HC
 HD
 HE
 HF
 HG
 HH
 HI
 HJ
 HK
 HL
 HM
 HN
 HO
 HP
 HQ
 HR
 HS
 HT
 HU
 HV
 HW
 HX
 HY
 HZ
 IA
 IB
 IC
 ID
 IE
 IF
 IG
 IH
 II
 IJ
 IK
 IL
 IM
 IN
 IO
 IP
 IQ
 IR
 IS
 IT
 IU
 IV
 IW
 IX
 IY
 IZ
 JA
 JB
 JC
 JD
 JE
 JF
 JG
 JH
 JI
 JJ
 JK
 JL
 JM
 JN
 JO
 JP
 JQ
 JR
 JS
 JT
 JU
 JV
 JW
 JX
 JY
 JZ
 KA
 KB
 KC
 KD
 KE
 KF
 KG
 KH
 KI
 KJ
 KK
 KL
 KM
 KN
 KO
 KP
 KQ
 KR
 KS
 KT
 KU
 KV
 KW
 KX
 KY
 KZ
 LA
 LB
 LC
 LD
 LE
 LF
 LG
 LH
 LI
 LJ
 LK
 LL
 LM
 LN
 LO
 LP
 LQ
 LR
 LS
 LT
 LU
 LV
 LW
 LX
 LY
 LZ
 MA
 MB
 MC
 MD
 ME
 MF
 MG
 MH
 MI
 MJ
 MK
 ML
 MM
 MN
 MO
 MP
 MQ
 MR
 MS
 MT
 MU
 MV
 MW
 MX
 MY
 MZ
 NA
 NB
 NC
 ND
 NE
 NF
 NG
 NH
 NI
 NJ
 NK
 NL
 NM
 NN
 NO
 NP
 NQ
 NR
 NS
 NT
 NU
 NV
 NW
 NX
 NY
 NZ
 OA
 OB
 OC
 OD
 OE
 OF
 OG
 OH
 OI
 OJ
 OK
 OL
 OM
 ON
 OO
 OP
 OQ
 OR
 OS
 OT
 OU
 OV
 OW
 OX
 OY
 OZ
 PA
 PB
 PC
 PD
 PE
 PF
 PG
 PH
 PI
 PJ
 PK
 PL
 PM
 PN
 PO
 PP
 PQ
 PR
 PS
 PT
 PU
 PV
 PW
 PX
 PY
 PZ
 QA
 QB
 QC
 QD
 QE
 QF
 QG
 QH
 QI
 QJ
 QK
 QL
 QM
 QN
 QO
 QP
 QQ
 QR
 QS
 QT
 QU
 QV
 QW
 QX
 QY
 QZ
 RA
 RB
 RC
 RD
 RE
 RF
 RG
 RH
 RI
 RJ
 RK
 RL
 RM
 RN
 RO
 RP
 RQ
 RR
 RS
 RT
 RU
 RV
 RW
 RX
 RY
 RZ
 SA
 SB
 SC
 SD
 SE
 SF
 SG
 SH
 SI
 SJ
 SK
 SL
 SM
 SN
 SO
 SP
 SQ
 SR
 SS
 ST
 SU
 SV
 SW
 SX
 SY
 SZ
 TA
 TB
 TC
 TD
 TE
 TF
 TG
 TH
 TI
 TJ
 TK
 TL
 TM
 TN
 TO
 TP
 TQ
 TR
 TS
 TT
 TU
 TV
 TW
 TX
 TY
 TZ
 UA
 UB
 UC
 UD
 UE
 UF
 UG
 UH
 UI
 UJ
 UK
 UL
 UM
 UN
 UO
 UP
 UQ
 UR
 US
 UT
 UU
 UV
 UW
 UX
 UY
 UZ
 VA
 VB
 VC
 VD
 VE
 VF
 VG
 VH
 VI
 VJ
 VK
 VL
 VM
 VN
 VO
 VP
 VQ
 VR
 VS
 VT
 VU
 VV
 VW
 VX
 VY
 VZ
 WA
 WB
 WC
 WD
 WE
 WF
 WG
 WH
 WI
 WJ
 WK
 WL
 WM
 WN
 WO
 WP
 WQ
 WR
 WS
 WT
 WU
 WV
 WW
 WX
 WY
 WZ
 XA
 XB
 XC
 XD
 XE
 XF
 XG
 XH
 XI
 XJ
 XK
 XL
 XM
 XN
 XO
 XP
 XQ
 XR
 XS
 XT
 XU
 XV
 XW
 XX
 XY
 XZ
 YA
 YB
 YC
 YD
 YE
 YF
 YG
 YH
 YI
 YJ
 YK
 YL
 YM
 YN
 YO
 YP
 YQ
 YR
 YS
 YT
 YU
 YV
 YW
 YX
 YZ
 ZA
 ZB
 ZC
 ZD
 ZE
 ZF
 ZG
 ZH
 ZI
 ZJ
 ZK
 ZL
 ZM
 ZN
 ZO
 ZP
 ZQ
 ZR
 ZS
 ZT
 ZU
 ZV
 ZW
 ZX
 ZY
 ZZ

Zahnzangen, englische Modelle
 Extracting forceps, english pattern
 Fórceps de extracción, forma inglesa
 Daviers, modèle anglaise
 Pinza per estrazione, modello inglese



Fig. 74M
 PA 074/06



Fig. 74N
 PA 074/07



Fig. 75
 PA 075/00

ZAHNZANGEN EXTRACTING FORCEPS FORCEPS DE EXTRACCION DAVIERS PINZA PER ESTRAZIONE

Zahnzangen, englische Modelle
 Extracting forceps, english pattern
 Fórceps de extracción, forma inglesa
 Daviers, modèle anglaise
 Pinza per estrazione, modello inglese



LAWRENCE-READ
 Fig.76
 PA 076/00



LAWRENCE-READ
 Fig.76N
 PA 076/07

AA
 AB
 AC
 AD
 AE
 AF
 AG
 AH
 AI
 AJ
 AK
 AL
 AO
 AP
 AQ
 AR
 AS
 AT
 AU
 AV
 AW
 AX
 AY
 AZ
 BA
 BB
 BC
 BD
 BE
 BF
 BG
 BH
 BI
 BJ
 BK
 BL
 BM
 BN
 BO
 BP
 BQ
 BR
 BS
 BT
 BU
 BV
 BW
 BX
 BY
 BZ
 CA
 CB
 CC
 CD
 CE
 CF
 CG
 CH
 CI
 CJ
 CK
 CL
 CM
 CN
 CO
 CP
 CQ
 CR
 CS
 CT
 CU
 CV
 CW
 CX
 CY
 CZ
 DA
 DB
 DC
 DD
 DE
 DF
 DG
 DH
 DI
 DJ
 DK
 DL
 DM
 DN
 DO
 DP
 DQ
 DR
 DS
 DT
 DU
 DV
 DW
 DX
 DY
 DZ
 EA
 EB
 EC
 ED
 EE
 EF
 EG
 EH
 EI
 EJ
 EK
 EL
 EM
 EN
 EO
 EP
 EQ
 ER
 ES
 ET
 EU
 EV
 EW
 EX
 EY
 EZ
 FA
 FB
 FC
 FD
 FE
 FF
 FG
 FH
 FI
 FJ
 FK
 FL
 FM
 FN
 FO
 FP
 FQ
 FR
 FS
 FT
 FU
 FV
 FW
 FX
 FY
 FZ
 GA
 GB
 GC
 GD
 GE
 GF
 GG
 GH
 GI
 GJ
 GK
 GL
 GM
 GN
 GO
 GP
 GQ
 GR
 GS
 GT
 GU
 GV
 GW
 GX
 GY
 GZ
 HA
 HB
 HC
 HD
 HE
 HF
 HG
 HH
 HI
 HJ
 HK
 HL
 HM
 HN
 HO
 HP
 HQ
 HR
 HS
 HT
 HU
 HV
 HW
 HX
 HY
 HZ
 IA
 IB
 IC
 ID
 IE
 IF
 IG
 IH
 II
 IJ
 IK
 IL
 IM
 IN
 IO
 IP
 IQ
 IR
 IS
 IT
 IU
 IV
 IW
 IX
 IY
 IZ
 JA
 JB
 JC
 JD
 JE
 JF
 JG
 JH
 JI
 JJ
 JK
 JL
 JM
 JN
 JO
 JP
 JQ
 JR
 JS
 JT
 JU
 JV
 JW
 JX
 JY
 JZ
 KA
 KB
 KC
 KD
 KE
 KF
 KG
 KH
 KI
 KJ
 KK
 KL
 KM
 KN
 KO
 KP
 KQ
 KR
 KS
 KT
 KU
 KV
 KW
 KX
 KY
 KZ
 LA
 LB
 LC
 LD
 LE
 LF
 LG
 LH
 LI
 LJ
 LK
 LL
 LM
 LN
 LO
 LP
 LQ
 LR
 LS
 LT
 LU
 LV
 LW
 LX
 LY
 LZ
 MA
 MB
 MC
 MD
 ME
 MF
 MG
 MH
 MI
 MJ
 MK
 ML
 MM
 MN
 MO
 MP
 MQ
 MR
 MS
 MT
 MU
 MV
 MW
 MX
 MY
 MZ
 NA
 NB
 NC
 ND
 NE
 NF
 NG
 NH
 NI
 NJ
 NK
 NL
 NM
 NN
 NO
 NP
 NQ
 NR
 NS
 NT
 NU
 NV
 NW
 NX
 NY
 NZ
 OA
 OB
 OC
 OD
 OE
 OF
 OG
 OH
 OI
 OJ
 OK
 OL
 OM
 ON
 OO
 OP
 OQ
 OR
 OS
 OT
 OU
 OV
 OW
 OX
 OY
 OZ
 PA
 PB
 PC
 PD
 PE
 PF
 PG
 PH
 PI
 PJ
 PK
 PL
 PM
 PN
 PO
 PP
 PQ
 PR
 PS
 PT
 PU
 PV
 PW
 PX
 PY
 PZ
 QA
 QB
 QC
 QD
 QE
 QF
 QG
 QH
 QI
 QJ
 QK
 QL
 QM
 QN
 QO
 QP
 QQ
 QR
 QS
 QT
 QU
 QV
 QW
 QX
 QY
 QZ
 RA
 RB
 RC
 RD
 RE
 RF
 RG
 RH
 RI
 RJ
 RK
 RL
 RM
 RN
 RO
 RP
 RQ
 RR
 RS
 RT
 RU
 RV
 RW
 RX
 RY
 RZ
 SA
 SB
 SC
 SD
 SE
 SF
 SG
 SH
 SI
 SJ
 SK
 SL
 SM
 SN
 SO
 SP
 SQ
 SR
 SS
 ST
 SU
 SV
 SW
 SX
 SY
 SZ
 TA
 TB
 TC
 TD
 TE
 TF
 TG
 TH
 TI
 TJ
 TK
 TL
 TM
 TN
 TO
 TP
 TQ
 TR
 TS
 TT
 TU
 TV
 TW
 TX
 TY
 TZ
 UA
 UB
 UC
 UD
 UE
 UF
 UG
 UH
 UI
 UJ
 UK
 UL
 UM
 UN
 UO
 UP
 UQ
 UR
 US
 UT
 UU
 UV
 UW
 UX
 UY
 UZ
 VA
 VB
 VC
 VD
 VE
 VF
 VG
 VH
 VI
 VJ
 VK
 VL
 VM
 VN
 VO
 VP
 VQ
 VR
 VS
 VT
 VU
 VV
 VW
 VX
 VY
 VZ
 WA
 WB
 WC
 WD
 WE
 WF
 WG
 WH
 WI
 WJ
 WK
 WL
 WM
 WN
 WO
 WP
 WQ
 WR
 WS
 WT
 WU
 WV
 WW
 WX
 WY
 WZ
 XA
 XB
 XC
 XD
 XE
 XF
 XG
 XH
 XI
 XJ
 XK
 XL
 XM
 XN
 XO
 XP
 XQ
 XR
 XS
 XT
 XU
 XV
 XW
 XX
 XY
 XZ
 YA
 YB
 YC
 YD
 YE
 YF
 YG
 YH
 YI
 YJ
 YK
 YL
 YM
 YN
 YO
 YP
 YQ
 YR
 YS
 YT
 YU
 YV
 YW
 YX
 YZ
 ZA
 ZB
 ZC
 ZD
 ZE
 ZF
 ZG
 ZH
 ZI
 ZJ
 ZK
 ZL
 ZM
 ZN
 ZO
 ZP
 ZQ
 ZR
 ZS
 ZT
 ZU
 ZV
 ZW
 ZX
 ZY
 ZZ

Zahnzangen, englische Modelle
 Extracting forceps, english pattern
 Fórceps de extracción, forma inglesa
 Daviers, modèle anglaise
 Pinza per estrazione, modello inglese



Fig. 79
 PA 079/00



Fig. 79A
 PA 079/01



Fig. 79N
 PA 079/02

ZAHNZANGEN EXTRACTING FORCEPS FORCEPS DE EXTRACCION DAVIERS PINZA PER ESTRAZIONE

Zahnzangen, englische Modelle
 Extracting forceps, english pattern
 Fórceps de extracción, forma inglesa
 Daviers, modèle anglaise
 Pinza per estrazione, modello inglese



Fig.86A
 PA 086/01



Fig.86B
 PA 086/02



Fig.86C
 PA 086/03

AA
 AB
 AC
 AD
 AE
 AF
 AG
 AH
 AI
 AJ
 AK
 AL
 AM
 AN
 AO
 AP
 AQ
 AR
 AS
 AT
 AU
 AV
 AW
 AX
 AY
 AZ
 BA
 BB
 BC
 BD
 BE
 BF
 BG
 BH
 BI
 BJ
 BK
 BL
 BM
 BN
 BO
 BP
 BQ
 BR
 BS
 BT
 BU
 BV
 BW
 BX
 BY
 BZ
 CA
 CB
 CC
 CD
 CE
 CF
 CG
 CH
 CI
 CJ
 CK
 CL
 CM
 CN
 CO
 CP
 CQ
 CR
 CS
 CT
 CU
 CV
 CW
 CX
 CY
 CZ
 DA
 DB
 DC
 DD
 DE
 DF
 DG
 DH
 DI
 DJ
 DK
 DL
 DM
 DN
 DO
 DP
 DQ
 DR
 DS
 DT
 DU
 DV
 DW
 DX
 DY
 DZ
 EA
 EB
 EC
 ED
 EE
 EF
 EG
 EH
 EI
 EJ
 EK
 EL
 EM
 EN
 EO
 EP
 EQ
 ER
 ES
 ET
 EU
 EV
 EW
 EX
 EY
 EZ
 FA
 FB
 FC
 FD
 FE
 FF
 FG
 FH
 FI
 FJ
 FK
 FL
 FM
 FN
 FO
 FP
 FQ
 FR
 FS
 FT
 FU
 FV
 FW
 FX
 FY
 FZ
 GA
 GB
 GC
 GD
 GE
 GF
 GG
 GH
 GI
 GJ
 GK
 GL
 GM
 GN
 GO
 GP
 GQ
 GR
 GS
 GT
 GU
 GV
 GW
 GX
 GY
 GZ
 HA
 HB
 HC
 HD
 HE
 HF
 HG
 HH
 HI
 HJ
 HK
 HL
 HM
 HN
 HO
 HP
 HQ
 HR
 HS
 HT
 HU
 HV
 HW
 HX
 HY
 HZ
 IA
 IB
 IC
 ID
 IE
 IF
 IG
 IH
 II
 IJ
 IK
 IL
 IM
 IN
 IO
 IP
 IQ
 IR
 IS
 IT
 IU
 IV
 IW
 IX
 IY
 IZ
 JA
 JB
 JC
 JD
 JE
 JF
 JG
 JH
 JI
 JJ
 JK
 JL
 JM
 JN
 JO
 JP
 JQ
 JR
 JS
 JT
 JU
 JV
 JW
 JX
 JY
 JZ
 KA
 KB
 KC
 KD
 KE
 KF
 KG
 KH
 KI
 KJ
 KK
 KL
 KM
 KN
 KO
 KP
 KQ
 KR
 KS
 KT
 KU
 KV
 KW
 KX
 KY
 KZ
 LA
 LB
 LC
 LD
 LE
 LF
 LG
 LH
 LI
 LJ
 LK
 LL
 LM
 LN
 LO
 LP
 LQ
 LR
 LS
 LT
 LU
 LV
 LW
 LX
 LY
 LZ
 MA
 MB
 MC
 MD
 ME
 MF
 MG
 MH
 MI
 MJ
 MK
 ML
 MM
 MN
 MO
 MP
 MQ
 MR
 MS
 MT
 MU
 MV
 MW
 MX
 MY
 MZ
 NA
 NB
 NC
 ND
 NE
 NF
 NG
 NH
 NI
 NJ
 NK
 NL
 NM
 NN
 NO
 NP
 NQ
 NR
 NS
 NT
 NU
 NV
 NW
 NX
 NY
 NZ
 OA
 OB
 OC
 OD
 OE
 OF
 OG
 OH
 OI
 OJ
 OK
 OL
 OM
 ON
 OO
 OP
 OQ
 OR
 OS
 OT
 OU
 OV
 OW
 OX
 OY
 OZ
 PA
 PB
 PC
 PD
 PE
 PF
 PG
 PH
 PI
 PJ
 PK
 PL
 PM
 PN
 PO
 PP
 PQ
 PR
 PS
 PT
 PU
 PV
 PW
 PX
 PY
 PZ
 QA
 QB
 QC
 QD
 QE
 QF
 QG
 QH
 QI
 QJ
 QK
 QL
 QM
 QN
 QO
 QP
 QQ
 QR
 QS
 QT
 QU
 QV
 QW
 QX
 QY
 QZ
 RA
 RB
 RC
 RD
 RE
 RF
 RG
 RH
 RI
 RJ
 RK
 RL
 RM
 RN
 RO
 RP
 RQ
 RR
 RS
 RT
 RU
 RV
 RW
 RX
 RY
 RZ
 SA
 SB
 SC
 SD
 SE
 SF
 SG
 SH
 SI
 SJ
 SK
 SL
 SM
 SN
 SO
 SP
 SQ
 SR
 SS
 ST
 SU
 SV
 SW
 SX
 SY
 SZ
 TA
 TB
 TC
 TD
 TE
 TF
 TG
 TH
 TI
 TJ
 TK
 TL
 TM
 TN
 TO
 TP
 TQ
 TR
 TS
 TT
 TU
 TV
 TW
 TX
 TY
 TZ
 UA
 UB
 UC
 UD
 UE
 UF
 UG
 UH
 UI
 UJ
 UK
 UL
 UM
 UN
 UO
 UP
 UQ
 UR
 US
 UT
 UU
 UV
 UW
 UX
 UY
 UZ
 VA
 VB
 VC
 VD
 VE
 VF
 VG
 VH
 VI
 VJ
 VK
 VL
 VM
 VN
 VO
 VP
 VQ
 VR
 VS
 VT
 VU
 VV
 VW
 VX
 VY
 VZ
 WA
 WB
 WC
 WD
 WE
 WF
 WG
 WH
 WI
 WJ
 WK
 WL
 WM
 WN
 WO
 WP
 WQ
 WR
 WS
 WT
 WU
 WV
 WW
 WX
 WY
 WZ
 XA
 XB
 XC
 XD
 XE
 XF
 XG
 XH
 XI
 XJ
 XK
 XL
 XM
 XN
 XO
 XP
 XQ
 XR
 XS
 XT
 XU
 XV
 XW
 XX
 XY
 XZ
 YA
 YB
 YC
 YD
 YE
 YF
 YG
 YH
 YI
 YJ
 YK
 YL
 YM
 YN
 YO
 YP
 YQ
 YR
 YS
 YT
 YU
 YV
 YW
 YX
 YY
 YZ
 ZA
 ZB
 ZC
 ZD
 ZE
 ZF
 ZG
 ZH
 ZI
 ZJ
 ZK
 ZL
 ZM
 ZN
 ZO
 ZP
 ZQ
 ZR
 ZS
 ZT
 ZU
 ZV
 ZW
 ZX
 ZY
 ZZ

Zahnzangen, englische Modelle
 Extracting forceps, english pattern
 Fórceps de extracción, forma inglesa
 Daviers, modèle anglaise
 Pinza per estrazione, modello inglese

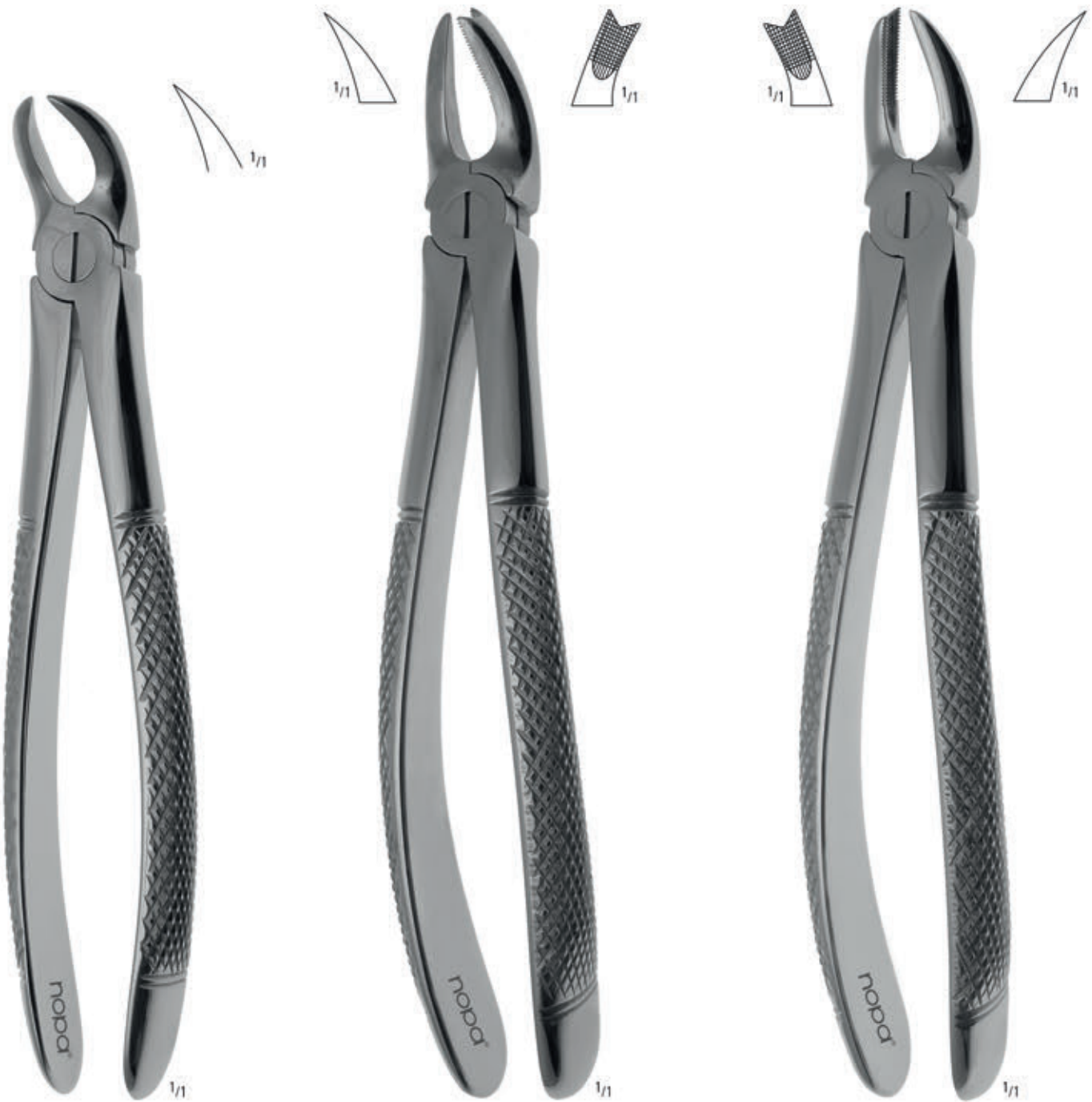

Fig.87
 PA 087/00

Fig.89
 PA 089/00

Fig.90
 PA 090/00

ZAHNZANGEN EXTRACTING FORCEPS FORCEPS DE EXTRACCION DAVIERS PINZA PER ESTRAZIONE

Zahnzangen, englische Modelle
 Extracting forceps, english pattern
 Fórceps de extracción, forma inglesa
 Daviers, modèle anglaise
 Pinza per estrazione, modello inglese



Fig.97
 PA 097/00



Fig.136
 PA 136/00

AA
 AB
 AC
 AD
 AE
 AF
 AG
 AH
 AI
 AJ
 AK
 AL
 AM
 AN
 AO
 AP
 AQ
 AR
 AS
 AT
 AU
 AV
 AW
 AX
 AY
 AZ
 BA
 BB
 BC
 BD
 BE
 BF
 BG
 BH
 BI
 BJ
 BK
 BL
 BM
 BN
 BO
 BP
 BQ
 BR
 BS
 BT
 BU
 BV
 BW
 BX
 BY
 BZ
 CA
 CB
 CC
 CD
 CE
 CF
 CG
 CH
 CI
 CJ
 CK
 CL
 CM
 CN
 CO
 CP
 CQ
 CR
 CS
 CT
 CU
 CV
 CW
 CX
 CY
 CZ
 DA
 DB
 DC
 DD
 DE
 DF
 DG
 DH
 DI
 DJ
 DK
 DL
 DM
 DN
 DO
 DP
 DQ
 DR
 DS
 DT
 DU
 DV
 DW
 DX
 DY
 DZ
 EA
 EB
 EC
 ED
 EE
 EF
 EG
 EH
 EI
 EJ
 EK
 EL
 EM
 EN
 EO
 EP
 EQ
 ER
 ES
 ET
 EU
 EV
 EW
 EX
 EY
 EZ
 FA
 FB
 FC
 FD
 FE
 FF
 FG
 FH
 FI
 FJ
 FK
 FL
 FM
 FN
 FO
 FP
 FQ
 FR
 FS
 FT
 FU
 FV
 FW
 FX
 FY
 FZ
 GA
 GB
 GC
 GD
 GE
 GF
 GG
 GH
 GI
 GJ
 GK
 GL
 GM
 GN
 GO
 GP
 GQ
 GR
 GS
 GT
 GU
 GV
 GW
 GX
 GY
 GZ
 HA
 HB
 HC
 HD
 HE
 HF
 HG
 HH
 HI
 HJ
 HK
 HL
 HM
 HN
 HO
 HP
 HQ
 HR
 HS
 HT
 HU
 HV
 HW
 HX
 HY
 HZ
 IA
 IB
 IC
 ID
 IE
 IF
 IG
 IH
 II
 IJ
 IK
 IL
 IM
 IN
 IO
 IP
 IQ
 IR
 IS
 IT
 IU
 IV
 IW
 IX
 IY
 IZ
 JA
 JB
 JC
 JD
 JE
 JF
 JG
 JH
 JI
 JJ
 JK
 JL
 JM
 JN
 JO
 JP
 JQ
 JR
 JS
 JT
 JU
 JV
 JW
 JX
 JY
 JZ
 KA
 KB
 KC
 KD
 KE
 KF
 KG
 KH
 KI
 KJ
 KK
 KL
 KM
 KN
 KO
 KP
 KQ
 KR
 KS
 KT
 KU
 KV
 KW
 KX
 KY
 KZ
 LA
 LB
 LC
 LD
 LE
 LF
 LG
 LH
 LI
 LJ
 LK
 LL
 LM
 LN
 LO
 LP
 LQ
 LR
 LS
 LT
 LU
 LV
 LW
 LX
 LY
 LZ
 MA
 MB
 MC
 MD
 ME
 MF
 MG
 MH
 MI
 MJ
 MK
 ML
 MM
 MN
 MO
 MP
 MQ
 MR
 MS
 MT
 MU
 MV
 MW
 MX
 MY
 MZ
 NA
 NB
 NC
 ND
 NE
 NF
 NG
 NH
 NI
 NJ
 NK
 NL
 NM
 NN
 NO
 NP
 NQ
 NR
 NS
 NT
 NU
 NV
 NW
 NX
 NY
 NZ
 OA
 OB
 OC
 OD
 OE
 OF
 OG
 OH
 OI
 OJ
 OK
 OL
 OM
 ON
 OO
 OP
 OQ
 OR
 OS
 OT
 OU
 OV
 OW
 OX
 OY
 OZ
 PA
 PB
 PC
 PD
 PE
 PF
 PG
 PH
 PI
 PJ
 PK
 PL
 PM
 PN
 PO
 PP
 PQ
 PR
 PS
 PT
 PU
 PV
 PW
 PX
 PY
 PZ
 QA
 QB
 QC
 QD
 QE
 QF
 QG
 QH
 QI
 QJ
 QK
 QL
 QM
 QN
 QO
 QP
 QQ
 QR
 QS
 QT
 QU
 QV
 QW
 QX
 QY
 QZ
 RA
 RB
 RC
 RD
 RE
 RF
 RG
 RH
 RI
 RJ
 RK
 RL
 RM
 RN
 RO
 RP
 RQ
 RR
 RS
 RT
 RU
 RV
 RW
 RX
 RY
 RZ
 SA
 SB
 SC
 SD
 SE
 SF
 SG
 SH
 SI
 SJ
 SK
 SL
 SM
 SN
 SO
 SP
 SQ
 SR
 SS
 ST
 SU
 SV
 SW
 SX
 SY
 SZ
 TA
 TB
 TC
 TD
 TE
 TF
 TG
 TH
 TI
 TJ
 TK
 TL
 TM
 TN
 TO
 TP
 TQ
 TR
 TS
 TT
 TU
 TV
 TW
 TX
 TY
 TZ
 UA
 UB
 UC
 UD
 UE
 UF
 UG
 UH
 UI
 UJ
 UK
 UL
 UM
 UN
 UO
 UP
 UQ
 UR
 US
 UT
 UU
 UV
 UW
 UX
 UY
 UZ
 VA
 VB
 VC
 VD
 VE
 VF
 VG
 VH
 VI
 VJ
 VK
 VL
 VM
 VN
 VO
 VP
 VQ
 VR
 VS
 VT
 VU
 VV
 VW
 VX
 VY
 VZ
 WA
 WB
 WC
 WD
 WE
 WF
 WG
 WH
 WI
 WJ
 WK
 WL
 WM
 WN
 WO
 WP
 WQ
 WR
 WS
 WT
 WU
 WV
 WW
 WX
 WY
 WZ
 XA
 XB
 XC
 XD
 XE
 XF
 XG
 XH
 XI
 XJ
 XK
 XL
 XM
 XN
 XO
 XP
 XQ
 XR
 XS
 XT
 XU
 XV
 XW
 XX
 XY
 XZ
 YA
 YB
 YC
 YD
 YE
 YF
 YG
 YH
 YI
 YJ
 YK
 YL
 YM
 YN
 YO
 YP
 YQ
 YR
 YS
 YT
 YU
 YV
 YW
 YX
 YZ
 ZA
 ZB
 ZC
 ZD
 ZE
 ZF
 ZG
 ZH
 ZI
 ZJ
 ZK
 ZL
 ZM
 ZN
 ZO
 ZP
 ZQ
 ZR
 ZS
 ZT
 ZU
 ZV
 ZW
 ZX
 ZY
 ZZ

Zahnzangen, englische Modelle
 Extracting forceps, english pattern
 Fórceps de extracción, forma inglesa
 Daviers, modèle anglaise
 Pinza per estrazione, modello inglese



Fig.146
 PA 146/00



Fig.151
 PA 151/00

ZAHNZANGEN EXTRACTING FORCEPS FORCEPS DE EXTRACCION DAVIERS PINZA PER ESTRAZIONE

Zahnzangen, englische Modelle
 Extracting forceps, english pattern
 Fórceps de extracción, forma inglesa
 Daviers, modèle anglaise
 Pinza per estrazione, modello inglese



Fig.152
 PA 152/00



Fig.153
 PA 153/00

AA
 AB
 AC
 AD
 AE
 AF
 AG
 AH
 AI
 AJ
 AK
 AL
 AO
 AP
 AQ
 AR
 AS
 AT
 AU
 AV
 AW
 AX
 AY
 AZ
 BA
 BB
 BC
 BD
 BE
 BF
 BG
 BH
 BI
 BJ
 BK
 BL
 BM
 BN
 BO
 BP
 BQ
 BR
 BS
 BT
 BU
 BV
 BW
 BX
 BY
 BZ
 CA
 CB
 CC
 CD
 CE
 CF
 CG
 CH
 CI
 CJ
 CK
 CL
 CM
 CN
 CO
 CP
 CQ
 CR
 CS
 CT
 CU
 CV
 CW
 CX
 CY
 CZ
 DA
 DB
 DC
 DD
 DE
 DF
 DG
 DH
 DI
 DJ
 DK
 DL
 DM
 DN
 DO
 DP
 DQ
 DR
 DS
 DT
 DU
 DV
 DW
 DX
 DY
 DZ
 EA
 EB
 EC
 ED
 EE
 EF
 EG
 EH
 EI
 EJ
 EK
 EL
 EM
 EN
 EO
 EP
 EQ
 ER
 ES
 ET
 EU
 EV
 EW
 EX
 EY
 EZ
 FA
 FB
 FC
 FD
 FE
 FF
 FG
 FH
 FI
 FJ
 FK
 FL
 FM
 FN
 FO
 FP
 FQ
 FR
 FS
 FT
 FU
 FV
 FW
 FX
 FY
 FZ
 GA
 GB
 GC
 GD
 GE
 GF
 GG
 GH
 GI
 GJ
 GK
 GL
 GM
 GN
 GO
 GP
 GQ
 GR
 GS
 GT
 GU
 GV
 GW
 GX
 GY
 GZ
 HA
 HB
 HC
 HD
 HE
 HF
 HG
 HH
 HI
 HJ
 HK
 HL
 HM
 HN
 HO
 HP
 HQ
 HR
 HS
 HT
 HU
 HV
 HW
 HX
 HY
 HZ
 IA
 IB
 IC
 ID
 IE
 IF
 IG
 IH
 II
 IJ
 IK
 IL
 IM
 IN
 IO
 IP
 IQ
 IR
 IS
 IT
 IU
 IV
 IW
 IX
 IY
 IZ
 JA
 JB
 JC
 JD
 JE
 JF
 JG
 JH
 JI
 JJ
 JK
 JL
 JM
 JN
 JO
 JP
 JQ
 JR
 JS
 JT
 JU
 JV
 JW
 JX
 JY
 JZ
 KA
 KB
 KC
 KD
 KE
 KF
 KG
 KH
 KI
 KJ
 KK
 KL
 KM
 KN
 KO
 KP
 KQ
 KR
 KS
 KT
 KU
 KV
 KW
 KX
 KY
 KZ
 LA
 LB
 LC
 LD
 LE
 LF
 LG
 LH
 LI
 LJ
 LK
 LL
 LM
 LN
 LO
 LP
 LQ
 LR
 LS
 LT
 LU
 LV
 LW
 LX
 LY
 LZ
 MA
 MB
 MC
 MD
 ME
 MF
 MG
 MH
 MI
 MJ
 MK
 ML
 MM
 MN
 MO
 MP
 MQ
 MR
 MS
 MT
 MU
 MV
 MW
 MX
 MY
 MZ
 NA
 NB
 NC
 ND
 NE
 NF
 NG
 NH
 NI
 NJ
 NK
 NL
 NM
 NN
 NO
 NP
 NQ
 NR
 NS
 NT
 NU
 NV
 NW
 NX
 NY
 NZ
 OA
 OB
 OC
 OD
 OE
 OF
 OG
 OH
 OI
 OJ
 OK
 OL
 OM
 ON
 OO
 OP
 OQ
 OR
 OS
 OT
 OU
 OV
 OW
 OX
 OY
 OZ
 PA
 PB
 PC
 PD
 PE
 PF
 PG
 PH
 PI
 PJ
 PK
 PL
 PM
 PN
 PO
 PP
 PQ
 PR
 PS
 PT
 PU
 PV
 PW
 PX
 PY
 PZ
 QA
 QB
 QC
 QD
 QE
 QF
 QG
 QH
 QI
 QJ
 QK
 QL
 QM
 QN
 QO
 QP
 QQ
 QR
 QS
 QT
 QU
 QV
 QW
 QX
 QY
 QZ
 RA
 RB
 RC
 RD
 RE
 RF
 RG
 RH
 RI
 RJ
 RK
 RL
 RM
 RN
 RO
 RP
 RQ
 RR
 RS
 RT
 RU
 RV
 RW
 RX
 RY
 RZ
 SA
 SB
 SC
 SD
 SE
 SF
 SG
 SH
 SI
 SJ
 SK
 SL
 SM
 SN
 SO
 SP
 SQ
 SR
 SS
 ST
 SU
 SV
 SW
 SX
 SY
 SZ
 TA
 TB
 TC
 TD
 TE
 TF
 TG
 TH
 TI
 TJ
 TK
 TL
 TM
 TN
 TO
 TP
 TQ
 TR
 TS
 TT
 TU
 TV
 TW
 TX
 TY
 TZ
 UA
 UB
 UC
 UD
 UE
 UF
 UG
 UH
 UI
 UJ
 UK
 UL
 UM
 UN
 UO
 UP
 UQ
 UR
 US
 UT
 UU
 UV
 UW
 UX
 UY
 UZ
 VA
 VB
 VC
 VD
 VE
 VF
 VG
 VH
 VI
 VJ
 VK
 VL
 VM
 VN
 VO
 VP
 VQ
 VR
 VS
 VT
 VU
 VV
 VW
 VX
 VY
 VZ
 WA
 WB
 WC
 WD
 WE
 WF
 WG
 WH
 WI
 WJ
 WK
 WL
 WM
 WN
 WO
 WP
 WQ
 WR
 WS
 WT
 WU
 WV
 WW
 WX
 WY
 WZ
 XA
 XB
 XC
 XD
 XE
 XF
 XG
 XH
 XI
 XJ
 XK
 XL
 XM
 XN
 XO
 XP
 XQ
 XR
 XS
 XT
 XU
 XV
 XW
 XX
 XY
 XZ
 YA
 YB
 YC
 YD
 YE
 YF
 YG
 YH
 YI
 YJ
 YK
 YL
 YM
 YN
 YO
 YP
 YQ
 YR
 YS
 YT
 YU
 YV
 YW
 YX
 YY
 YZ
 ZA
 ZB
 ZC
 ZD
 ZE
 ZF
 ZG
 ZH
 ZI
 ZJ
 ZK
 ZL
 ZM
 ZN
 ZO
 ZP
 ZQ
 ZR
 ZS
 ZT
 ZU
 ZV
 ZW
 ZX
 ZY
 ZZ

Zahnzangen, englische Modelle
 Extracting forceps, english pattern
 Fórceps de extracción, forma inglesa
 Daviers, modèle anglaise
 Pinza per estrazione, modello inglese



MEAD
 Fig.MD3
 PA 160/03



MEAD
 Fig.MD4
 PA 160/04

Zahnzangen, englische Modelle
 Extracting forceps, english pattern
 Fórceps de extracción, forma inglesa
 Daviers, modèle anglaise
 Pinza per estrazione, modello inglese

Elegance



Fig.1
PA 401/00



Fig.2
PA 402/00



Fig.7
PA 407/00

AA
AB
AC
AD
AE
AF
AK
AL
AO
AR
KA
KL
KU
PA
PB
PF
PI
PK
PL
PM
PP
PS
PT
PU
PV
KYE

Zahnzangen, englische Modelle
 Extracting forceps, english pattern
 Fórceps de extracción, forma inglesa
 Daviers, modèle anglaise
 Pinza per estrazione, modello inglese

Elegance



Fig. 13
 PA 413/00



Fig. 13S
 PA 413/09

Zahnzangen, englische Modelle
 Extracting forceps, english pattern
 Fórceps de extracción, forma inglesa
 Daviers, modèle anglaise
 Pinza per estrazione, modello inglese

Elegance



Fig.17
 PA 417/00



Fig.18
 PA 418/00

AA
 AB
 AC
 AD
 AE
 AF
 AG
 AH
 AI
 AJ
 AK
 AL
 AM
 AN
 AO
 AP
 AQ
 AR
 AS
 AT
 AU
 AV
 AW
 AX
 AY
 AZ
 BA
 BB
 BC
 BD
 BE
 BF
 BG
 BH
 BI
 BJ
 BK
 BL
 BM
 BN
 BO
 BP
 BQ
 BR
 BS
 BT
 BU
 BV
 BW
 BX
 BY
 BZ
 CA
 CB
 CC
 CD
 CE
 CF
 CG
 CH
 CI
 CJ
 CK
 CL
 CM
 CN
 CO
 CP
 CQ
 CR
 CS
 CT
 CU
 CV
 CW
 CX
 CY
 CZ
 DA
 DB
 DC
 DD
 DE
 DF
 DG
 DH
 DI
 DJ
 DK
 DL
 DM
 DN
 DO
 DP
 DQ
 DR
 DS
 DT
 DU
 DV
 DW
 DX
 DY
 DZ
 EA
 EB
 EC
 ED
 EE
 EF
 EG
 EH
 EI
 EJ
 EK
 EL
 EM
 EN
 EO
 EP
 EQ
 ER
 ES
 ET
 EU
 EV
 EW
 EX
 EY
 EZ
 FA
 FB
 FC
 FD
 FE
 FF
 FG
 FH
 FI
 FJ
 FK
 FL
 FM
 FN
 FO
 FP
 FQ
 FR
 FS
 FT
 FU
 FV
 FW
 FX
 FY
 FZ
 GA
 GB
 GC
 GD
 GE
 GF
 GG
 GH
 GI
 GJ
 GK
 GL
 GM
 GN
 GO
 GP
 GQ
 GR
 GS
 GT
 GU
 GV
 GW
 GX
 GY
 GZ
 HA
 HB
 HC
 HD
 HE
 HF
 HG
 HH
 HI
 HJ
 HK
 HL
 HM
 HN
 HO
 HP
 HQ
 HR
 HS
 HT
 HU
 HV
 HW
 HX
 HY
 HZ
 IA
 IB
 IC
 ID
 IE
 IF
 IG
 IH
 II
 IJ
 IK
 IL
 IM
 IN
 IO
 IP
 IQ
 IR
 IS
 IT
 IU
 IV
 IW
 IX
 IY
 IZ
 JA
 JB
 JC
 JD
 JE
 JF
 JG
 JH
 JI
 JJ
 JK
 JL
 JM
 JN
 JO
 JP
 JQ
 JR
 JS
 JT
 JU
 JV
 JW
 JX
 JY
 JZ
 KA
 KB
 KC
 KD
 KE
 KF
 KG
 KH
 KI
 KJ
 KK
 KL
 KM
 KN
 KO
 KP
 KQ
 KR
 KS
 KT
 KU
 KV
 KW
 KX
 KY
 KZ
 LA
 LB
 LC
 LD
 LE
 LF
 LG
 LH
 LI
 LJ
 LK
 LL
 LM
 LN
 LO
 LP
 LQ
 LR
 LS
 LT
 LU
 LV
 LW
 LX
 LY
 LZ
 MA
 MB
 MC
 MD
 ME
 MF
 MG
 MH
 MI
 MJ
 MK
 ML
 MM
 MN
 MO
 MP
 MQ
 MR
 MS
 MT
 MU
 MV
 MW
 MX
 MY
 MZ
 NA
 NB
 NC
 ND
 NE
 NF
 NG
 NH
 NI
 NJ
 NK
 NL
 NM
 NN
 NO
 NP
 NQ
 NR
 NS
 NT
 NU
 NV
 NW
 NX
 NY
 NZ
 OA
 OB
 OC
 OD
 OE
 OF
 OG
 OH
 OI
 OJ
 OK
 OL
 OM
 ON
 OO
 OP
 OQ
 OR
 OS
 OT
 OU
 OV
 OW
 OX
 OY
 OZ
 PA
 PB
 PC
 PD
 PE
 PF
 PG
 PH
 PI
 PJ
 PK
 PL
 PM
 PN
 PO
 PP
 PQ
 PR
 PS
 PT
 PU
 PV
 PW
 PX
 PY
 PZ
 QA
 QB
 QC
 QD
 QE
 QF
 QG
 QH
 QI
 QJ
 QK
 QL
 QM
 QN
 QO
 QP
 QQ
 QR
 QS
 QT
 QU
 QV
 QW
 QX
 QY
 QZ
 RA
 RB
 RC
 RD
 RE
 RF
 RG
 RH
 RI
 RJ
 RK
 RL
 RM
 RN
 RO
 RP
 RQ
 RR
 RS
 RT
 RU
 RV
 RW
 RX
 RY
 RZ
 SA
 SB
 SC
 SD
 SE
 SF
 SG
 SH
 SI
 SJ
 SK
 SL
 SM
 SN
 SO
 SP
 SQ
 SR
 SS
 ST
 SU
 SV
 SW
 SX
 SY
 SZ
 TA
 TB
 TC
 TD
 TE
 TF
 TG
 TH
 TI
 TJ
 TK
 TL
 TM
 TN
 TO
 TP
 TQ
 TR
 TS
 TT
 TU
 TV
 TW
 TX
 TY
 TZ
 UA
 UB
 UC
 UD
 UE
 UF
 UG
 UH
 UI
 UJ
 UK
 UL
 UM
 UN
 UO
 UP
 UQ
 UR
 US
 UT
 UU
 UV
 UW
 UX
 UY
 UZ
 VA
 VB
 VC
 VD
 VE
 VF
 VG
 VH
 VI
 VJ
 VK
 VL
 VM
 VN
 VO
 VP
 VQ
 VR
 VS
 VT
 VU
 VV
 VW
 VX
 VY
 VZ
 WA
 WB
 WC
 WD
 WE
 WF
 WG
 WH
 WI
 WJ
 WK
 WL
 WM
 WN
 WO
 WP
 WQ
 WR
 WS
 WT
 WU
 WV
 WW
 WX
 WY
 WZ
 XA
 XB
 XC
 XD
 XE
 XF
 XG
 XH
 XI
 XJ
 XK
 XL
 XM
 XN
 XO
 XP
 XQ
 XR
 XS
 XT
 XU
 XV
 XW
 XX
 XY
 XZ
 YA
 YB
 YC
 YD
 YE
 YF
 YG
 YH
 YI
 YJ
 YK
 YL
 YM
 YN
 YO
 YP
 YQ
 YR
 YS
 YT
 YU
 YV
 YW
 YX
 YY
 YZ
 ZA
 ZB
 ZC
 ZD
 ZE
 ZF
 ZG
 ZH
 ZI
 ZJ
 ZK
 ZL
 ZM
 ZN
 ZO
 ZP
 ZQ
 ZR
 ZS
 ZT
 ZU
 ZV
 ZW
 ZX
 ZY
 ZZ

Zahnzangen, englische Modelle
 Extracting forceps, english pattern
 Fórceps de extracción, forma inglesa
 Daviers, modèle anglaise
 Pinza per estrazione, modello inglese

Elegance



Fig.22
 PA 422/00



Fig.30
 PA 430/00

Zahnzangen, englische Modelle
 Extracting forceps, english pattern
 Fórceps de extracción, forma inglesa
 Daviers, modèle anglaise
 Pinza per estrazione, modello inglese

Elegance



Fig.33
 PA 433/00



Fig.39
 PA 439/00

AA
 AB
 AC
 AD
 AE
 AF
 AK
 AL
 AO
 AR
 KA
 KL
 KU
 PA
 PB
 PF
 PI
 PK
 PL
 PM
 PP
 PS
 PT
 PU
 PV
 KYE

Zahnzangen, englische Modelle
 Extracting forceps, english pattern
 Fórceps de extracción, forma inglesa
 Daviers, modèle anglaise
 Pinza per estrazione, modello inglese

Elegance



Fig. 51
PA 451/00



Fig. 51A
PA 451/01



Fig. 67A
PA 467/01

Zahnzangen, englische Modelle
 Extracting forceps, english pattern
 Fórceps de extracción, forma inglesa
 Daviers, modèle anglaise
 Pinza per estrazione, modello inglese

Elegance



Fig.73
 PA 473/00



Fig.74
 PA 474/00



Fig.74N
 PA 474/01

AA
 AB
 AC
 AD
 AE
 AF
 AK
 AL
 AO
 AR
 KA
 KL
 KU
PA
 PB
 PF
 PI
 PK
 PL
 PM
 PP
 PS
 PT
 PU
 PV
 KYE

Zahnzangen, englische Modelle
Extracting forceps, english pattern
Fórceps de extracción, forma inglesa
Daviers, modèle anglaise
Pinza per estrazione, modello inglese

Elegance



Fig.79
PA 479/00

ZAHNZANGEN EXTRACTING FORCEPS FORCEPS DE EXTRACCION DAVIERS PINZA PER ESTRAZIONE

Kinderzahnzangen, englische Modelle
 Extracting forceps for children, english pattern
 Pinzas de extracción para niños, forma inglesa
 Daviers pour enfants, modèle anglaise
 Pinze per estrazione per bambini, modello inglese



Fig.135
PA 513/09



Fig.225
PA 522/09



Fig.295
PA 529/09

AA
AB
AC
AD
AE
AF
AK
AL
AO
AR
KA
KL
KU
PA
PB
PF
PI
PK
PL
PM
PP
PS
PT
PU
PV
KYE

Kinderzahnzangen, englische Modelle
 Extracting forceps for children, english pattern
 Fórceps de extracción para niños, forma inglesa
 Daviers pour enfants, modèle anglaise
 Pinze per estrazione per bambini, modello inglese



Fig.30S
 PA 530/09



Fig.33S
 PA 533/09



Fig.37
 PA 537/00

ZAHNZANGEN EXTRACTING FORCEPS FORCEPS DE EXTRACCION DAVIERS PINZA PER ESTRAZIONE

Kinderzahnzangen, englische Modelle
 Extracting forceps for children, english pattern
 Fórceps de extracción para niños, forma inglesa
 Daviers pour enfants, modèle anglaise
 Pinze per estrazione per bambini, modello inglese



Fig.38
PA 538/00

Fig.39
PA 539/00

Fig.39L
PA 539/05

AA
AB
AC
AD
AE
AF
AK
AL
AO
AR
KA
KL
KU
PA
PB
PF
PI
PK
PL
PM
PP
PS
PT
PU
PV
KYE

Kinderzahnzangen, englische Modelle
 Extracting forceps for children, english pattern
 Fórceps de extracción para niños, forma inglesa
 Daviers pour enfants, modèle anglaise
 Pinze per estrazione per bambini, modello inglese



Fig.39R
 PA 539/08



Fig.51S
 PA 551/09

ZAHNZANGEN EXTRACTING FORCEPS FORCEPS DE EXTRACCION DAVIERS PINZA PER ESTRAZIONE

Kinderzahnzangen, englische Modelle
 Extracting forceps for children, english pattern
 Fórceps de extracción para niños, forma inglesa
 Daviers pour enfants, modèle anglaise
 Pinze per estrazione per bambini, modello inglese



KLEIN
 Fig.3
 PA 603/00



Fig.5
 PA 605/00

- AA
- AB
- AC
- AD
- AE
- AF
- AK
- AL
- AO
- AR
- KA
- KL
- KU
- PA**
- PB
- PF
- PI
- PK
- PL
- PM
- PP
- PS
- PT
- PU
- PV
- KYE

Kinderzahnzangen, englische Modelle
 Extracting forceps for children, english pattern
 Fórceps de extracción para niños, forma inglesa
 Daviers pour enfants, modèle anglaise
 Pinze per estrazione per bambini, modello inglese



Fig.6
 PA 606/00



Fig.7
 PA 607/00

ZAHNZANGEN EXTRACTING FORCEPS FORCEPS DE EXTRACCION DAVIERS PINZA PER ESTRAZIONE

Kinderzahnzangen, englische Modelle
 Extracting forceps for children, english pattern
 Fórceps de extracción para niños, forma inglesa
 Daviers pour enfants, modèle anglaise
 Pinze per estrazione per bambini, modello inglese



KLEIN
 Fig.137
 PA 637/00



KLEIN
 Fig.139
 PA 639/00

AA
 AB
 AC
 AD
 AE
 AF
 AK
 AL
 AO
 AR
 KA
 KL
 KU
 PA
 PB
 PF
 PI
 PK
 PL
 PM
 PP
 PS
 PT
 PU
 PV
 KYE

Kinderzahnzangen, englische Modelle
Extracting forceps for children, english pattern
Fórceps de extracción para niños, forma inglesa
Daviers pour enfants, modèle anglaise
Pinze per estrazione per bambini, modello inglese



KLEIN
Fig.51S
PA 651/09

ZAHNZANGEN EXTRACTING FORCEPS FORCEPS DE EXTRACCION DAVIERS PINZA PER ESTRAZIONE

Wurzelsplitterzangen
 Root fragment forceps
 Fórceps para fragmentos de raíces
 Daviers à fragments des racines
 Pinze per radici e frammenti



WITZEL
 Fig.1
 PA 705/01



WITZEL
 Fig.2
 PA 705/02



AA
 AB
 AC
 AD
 AE
 AF
 AK
 AL
 AO
 AR
 KA
 KL
 KU
 PA
 PB
 PF
 PI
 PK
 PL
 PM
 PP
 PS
 PT
 PU
 PV
 KYE

ZAHNZANGEN
EXTRACTING FORCEPS
FORCEPS DE EXTRACCION
DAVIERS
PINZA PER ESTRAZIONE

PB american pattern

nopa[®] instruments



Zahnzangen, amerikanische Modelle
 Extracting forceps, american pattern
 Fórceps de extracción, forma americana
 Daviers, modèle américaine
 Pinza per estrazione, modello americano

Einsatzbereiche der Zahnzangen
 Application-Charts for extracting forceps
 Tablas de aplicación para Forceps de extracción
 Tableaux d'application des daviers
 Tabella d'applicazione delle pinze per estrazione

Oberkiefer, Upper jaw, Mandibula Superior, Mâchoire supérieure, Mandibola superiore																
	8	7	6	5	4	3	2	1	1	2	3	4	5	6	7	8
FDI	18	17	16	15	14	13	12	11	21	22	23	24	25	26	27	28
				55	54	53	52	51	61	62	63	64	65			
Milchzähne, Temporary teeth, Dentadura temporaria, Denture temporaire, Denti di latte																

	rechts, right side, lado derecho, côté droit, lato destra	links, left side, lado izquierdo, côté gauche, lato sinistra	
Zahn, Tooth, Diente, Dent, Un Dente		Zahn, Tooth, Diente, Dent, Un Dente	
FDI		FDI	
11 (1)	1, 1A, 62, 65, 99C, 150, 150A, AS, S, X	21 (1)	1, 1A, 62, 65, 99C, 150, 150A, AS, S, X
51 (1)	62, 150SK	61 (1)	62, 150SK
12 (2)	1, 1A, 62, 65, 99C, 150, 150A, AS, S, X	22 (2)	1, 1A, 62, 65, 99C, 150, 150A, AS, S, X
52 (2)	62, 150 SK	62 (2)	62, 150SK
13 (3)	1, 62, 99C, 150	23 (3)	1, 62, 99C, 150
53 (3)	62, 150 SK	63 (3)	62, 150SK
14 (4)	32, 32A, 62, 150, 150A, AS, S, X	24 (4)	32, 32A, 62, 99C, 150, 150A, AS, S, X
54 (4)	62, 150SK	64 (4)	62, 150SK
15 (5)	32, 32A, 62, 150, 150A, AS, S, X	25 (5)	32, 32A, 62, 150, 150A, AS, S, X
55 (5)	62, 150SK	65 (5)	62, 150SK
16 (6)	10S, 18R, 24, 32, 32A, 53R, 62, 88R	26 (6)	10S, 18L, 24, 32, 32A, 53L, 62, 88L
17 (7)	10S, 18R, 24, 32, 32A, 53R, 62, 88R	27 (7)	10S, 18L, 24, 32, 32A, 53L, 62, 88L
18 (8)	10S, 210H	28 (8)	10S, 210H

Wurzeln, Roots, Raíces, Racines, Radici	
11 (1) - 28 (8)	32A, 62, 65, 69, 150, 150A, 150AS, 150S, 150X
51 (1) - 65 (5)	62, 150SK

ZAHNZANGEN EXTRACTING FORCEPS FORCEPS DE EXTRACCION DAVIERS PINZA PER ESTRAZIONE

Zahnzangen, amerikanische Modelle
 Extracting forceps, american pattern
 Fórceps de extracción, forma americana
 Daviers, modèle américaine
 Pinza per estrazione, modello americano

Einsatzbereiche der Zahnzangen
 Application-Charts for extracting forceps
 Tablas de aplicación para Forceps de extracción
 Tableaux d'application des daviers
 Tabella d'applicazione delle pinze per estrazione

Unterkiefer, Lower jaw, Mandibula inferior, Mâchoire inférieure, Mandibola inferiore																
	8	7	6	5	4	3	2	1	1	2	3	4	5	6	7	8
FDI	48	47	46	45	44	43	42	41	31	32	33	34	35	36	37	38
				85	84	83	82	81	71	72	73	74	75			
Milchzähne, Temporary teeth, Dentadura temporaria, Denture temporaire, Denti di latte																

	rechts, right side, lado derecho, côté droit, lato destra	links, left side, lado izquierdo, côté gauche, lato sinistra	
Zahn, Tooth, Diente, Dent, Un Dente		Zahn, Tooth, Diente, Dent, Un Dente	
FDI		FDI	
41 (1)	151, 151A, 151AS, 151S, 151X	31 (1)	151, 151A, 151AS, 151S, 151X
81 (1)	151SK	71 (1)	151SK
42 (2)	151, 151A, 151AS, 151S, 151X	32 (2)	151, 151A, 151AS, 151S, 151X
82 (2)	151SK	72 (2)	151SK
43 (3)	151S	33 (3)	151S
83 (3)	151SK	73 (3)	151SK
44 (4)	151, 151A, 151AS, 151S, 151X	34 (4)	151, 151A, 151AS, 151S, 151X
84 (4)	17SK, 23SK, 151SK	74 (4)	17SK, 23SK, 151SK
45 (5)	151, 151A, 151AS, 151S, 151X	35 (5)	151, 151A, 151AS, 151S, 151X
85 (5)	17SK, 23SK, 151SK	75 (5)	17SK, 23SK, 151SK
46 (6)	3FS, 15, 16, 17, 23, 151S	36 (6)	3FS, 15, 16, 17, 23, 151S
47 (7)	3FS, 15, 16, 17, 23, 151S	37 (7)	3FS, 15, 16, 17, 23, 151S
48 (8)	151S, 222	38 (8)	151S, 222

Wurzeln, Roots, Raíces, Racines, Radici	
31 (1) - 48 (8)	69, 151, 151A, 151AS, 151S, 151X
71 (1) - 85 (5)	151SK

AA AB AC AD AE AF AK AL AO AR KA KL KU PA PB PF PI PK PL PM PP PS PT PU PV KYE

Zahnzangen, amerikanische Modelle
 Extracting forceps, american pattern
 Fórceps de extracción, forma americana
 Daviers, modèle américaine
 Pinza per estrazione, modello americano



Fig. 1
PB 001/00



Fig. 1A
PB 001/01

ZAHNZANGEN EXTRACTING FORCEPS FORCEPS DE EXTRACCION DAVIERS PINZA PER ESTRAZIONE

Zahnzangen, amerikanische Modelle
 Extracting forceps, american pattern
 Fórceps de extracción, forma americana
 Daviers, modèle américaine
 Pinza per estrazione, modello americano



WOODWARD
 Fig.3FS
 PB 003/09



Fig.10S
 PB 010/09

AA
 AB
 AC
 AD
 AE
 AF
 AG
 AH
 AI
 AJ
 AK
 AL
 AO
 AP
 AQ
 AR
 AS
 AT
 AU
 AV
 AW
 AX
 AY
 AZ
 BA
 BB
 BC
 BD
 BE
 BF
 BG
 BH
 BI
 BJ
 BK
 BL
 BM
 BN
 BO
 BP
 BQ
 BR
 BS
 BT
 BU
 BV
 BW
 BX
 BY
 BZ
 CA
 CB
 CC
 CD
 CE
 CF
 CG
 CH
 CI
 CJ
 CK
 CL
 CM
 CN
 CO
 CP
 CQ
 CR
 CS
 CT
 CU
 CV
 CW
 CX
 CY
 CZ
 DA
 DB
 DC
 DD
 DE
 DF
 DG
 DH
 DI
 DJ
 DK
 DL
 DM
 DN
 DO
 DP
 DQ
 DR
 DS
 DT
 DU
 DV
 DW
 DX
 DY
 DZ
 EA
 EB
 EC
 ED
 EE
 EF
 EG
 EH
 EI
 EJ
 EK
 EL
 EM
 EN
 EO
 EP
 EQ
 ER
 ES
 ET
 EU
 EV
 EW
 EX
 EY
 EZ
 FA
 FB
 FC
 FD
 FE
 FF
 FG
 FH
 FI
 FJ
 FK
 FL
 FM
 FN
 FO
 FP
 FQ
 FR
 FS
 FT
 FU
 FV
 FW
 FX
 FY
 FZ
 GA
 GB
 GC
 GD
 GE
 GF
 GG
 GH
 GI
 GJ
 GK
 GL
 GM
 GN
 GO
 GP
 GQ
 GR
 GS
 GT
 GU
 GV
 GW
 GX
 GY
 GZ
 HA
 HB
 HC
 HD
 HE
 HF
 HG
 HH
 HI
 HJ
 HK
 HL
 HM
 HN
 HO
 HP
 HQ
 HR
 HS
 HT
 HU
 HV
 HW
 HX
 HY
 HZ
 IA
 IB
 IC
 ID
 IE
 IF
 IG
 IH
 II
 IJ
 IK
 IL
 IM
 IN
 IO
 IP
 IQ
 IR
 IS
 IT
 IU
 IV
 IW
 IX
 IY
 IZ
 JA
 JB
 JC
 JD
 JE
 JF
 JG
 JH
 JI
 JJ
 JK
 JL
 JM
 JN
 JO
 JP
 JQ
 JR
 JS
 JT
 JU
 JV
 JW
 JX
 JY
 JZ
 KA
 KB
 KC
 KD
 KE
 KF
 KG
 KH
 KI
 KJ
 KK
 KL
 KM
 KN
 KO
 KP
 KQ
 KR
 KS
 KT
 KU
 KV
 KW
 KX
 KY
 KZ
 LA
 LB
 LC
 LD
 LE
 LF
 LG
 LH
 LI
 LJ
 LK
 LL
 LM
 LN
 LO
 LP
 LQ
 LR
 LS
 LT
 LU
 LV
 LW
 LX
 LY
 LZ
 MA
 MB
 MC
 MD
 ME
 MF
 MG
 MH
 MI
 MJ
 MK
 ML
 MM
 MN
 MO
 MP
 MQ
 MR
 MS
 MT
 MU
 MV
 MW
 MX
 MY
 MZ
 NA
 NB
 NC
 ND
 NE
 NF
 NG
 NH
 NI
 NJ
 NK
 NL
 NM
 NN
 NO
 NP
 NQ
 NR
 NS
 NT
 NU
 NV
 NW
 NX
 NY
 NZ
 OA
 OB
 OC
 OD
 OE
 OF
 OG
 OH
 OI
 OJ
 OK
 OL
 OM
 ON
 OO
 OP
 OQ
 OR
 OS
 OT
 OU
 OV
 OW
 OX
 OY
 OZ
 PA
 PB
 PC
 PD
 PE
 PF
 PG
 PH
 PI
 PJ
 PK
 PL
 PM
 PN
 PO
 PP
 PQ
 PR
 PS
 PT
 PU
 PV
 PW
 PX
 PY
 PZ
 QA
 QB
 QC
 QD
 QE
 QF
 QG
 QH
 QI
 QJ
 QK
 QL
 QM
 QN
 QO
 QP
 QQ
 QR
 QS
 QT
 QU
 QV
 QW
 QX
 QY
 QZ
 RA
 RB
 RC
 RD
 RE
 RF
 RG
 RH
 RI
 RJ
 RK
 RL
 RM
 RN
 RO
 RP
 RQ
 RR
 RS
 RT
 RU
 RV
 RW
 RX
 RY
 RZ
 SA
 SB
 SC
 SD
 SE
 SF
 SG
 SH
 SI
 SJ
 SK
 SL
 SM
 SN
 SO
 SP
 SQ
 SR
 SS
 ST
 SU
 SV
 SW
 SX
 SY
 SZ
 TA
 TB
 TC
 TD
 TE
 TF
 TG
 TH
 TI
 TJ
 TK
 TL
 TM
 TN
 TO
 TP
 TQ
 TR
 TS
 TT
 TU
 TV
 TW
 TX
 TY
 TZ
 UA
 UB
 UC
 UD
 UE
 UF
 UG
 UH
 UI
 UJ
 UK
 UL
 UM
 UN
 UO
 UP
 UQ
 UR
 US
 UT
 UU
 UV
 UW
 UX
 UY
 UZ
 VA
 VB
 VC
 VD
 VE
 VF
 VG
 VH
 VI
 VJ
 VK
 VL
 VM
 VN
 VO
 VP
 VQ
 VR
 VS
 VT
 VU
 VV
 VW
 VX
 VY
 VZ
 WA
 WB
 WC
 WD
 WE
 WF
 WG
 WH
 WI
 WJ
 WK
 WL
 WM
 WN
 WO
 WP
 WQ
 WR
 WS
 WT
 WU
 WV
 WW
 WX
 WY
 WZ
 XA
 XB
 XC
 XD
 XE
 XF
 XG
 XH
 XI
 XJ
 XK
 XL
 XM
 XN
 XO
 XP
 XQ
 XR
 XS
 XT
 XU
 XV
 XW
 XX
 XY
 XZ
 YA
 YB
 YC
 YD
 YE
 YF
 YG
 YH
 YI
 YJ
 YK
 YL
 YM
 YN
 YO
 YP
 YQ
 YR
 YS
 YT
 YU
 YV
 YW
 YX
 YY
 YZ
 ZA
 ZB
 ZC
 ZD
 ZE
 ZF
 ZG
 ZH
 ZI
 ZJ
 ZK
 ZL
 ZM
 ZN
 ZO
 ZP
 ZQ
 ZR
 ZS
 ZT
 ZU
 ZV
 ZW
 ZX
 ZY
 ZZ

Zahnzangen, amerikanische Modelle
 Extracting forceps, american pattern
 Fórceps de extracción, forma americana
 Daviers, modèle américaine
 Pinza per estrazione, modello americano



Fig.15
 PB 015/00



Fig.16
 PB 016/00

ZAHNZANGEN EXTRACTING FORCEPS FORCEPS DE EXTRACCION DAVIERS PINZA PER ESTRAZIONE

Zahnzangen, amerikanische Modelle
 Extracting forceps, american pattern
 Fórceps de extracción, forma americana
 Daviers, modèle américaine
 Pinza per estrazione, modello americano



Fig.17
 PB 017/00

AA
 AB
 AC
 AD
 AE
 AF
 AG
 AH
 AI
 AJ
 AK
 AL
 AM
 AN
 AO
 AP
 AQ
 AR
 AS
 AT
 AU
 AV
 AW
 AX
 AY
 AZ
 BA
 BB
 BC
 BD
 BE
 BF
 BG
 BH
 BI
 BJ
 BK
 BL
 BM
 BN
 BO
 BP
 BQ
 BR
 BS
 BT
 BU
 BV
 BW
 BX
 BY
 BZ
 CA
 CB
 CC
 CD
 CE
 CF
 CG
 CH
 CI
 CJ
 CK
 CL
 CM
 CN
 CO
 CP
 CQ
 CR
 CS
 CT
 CU
 CV
 CW
 CX
 CY
 CZ
 DA
 DB
 DC
 DD
 DE
 DF
 DG
 DH
 DI
 DJ
 DK
 DL
 DM
 DN
 DO
 DP
 DQ
 DR
 DS
 DT
 DU
 DV
 DW
 DX
 DY
 DZ
 EA
 EB
 EC
 ED
 EE
 EF
 EG
 EH
 EI
 EJ
 EK
 EL
 EM
 EN
 EO
 EP
 EQ
 ER
 ES
 ET
 EU
 EV
 EW
 EX
 EY
 EZ
 FA
 FB
 FC
 FD
 FE
 FF
 FG
 FH
 FI
 FJ
 FK
 FL
 FM
 FN
 FO
 FP
 FQ
 FR
 FS
 FT
 FU
 FV
 FW
 FX
 FY
 FZ
 GA
 GB
 GC
 GD
 GE
 GF
 GG
 GH
 GI
 GJ
 GK
 GL
 GM
 GN
 GO
 GP
 GQ
 GR
 GS
 GT
 GU
 GV
 GW
 GX
 GY
 GZ
 HA
 HB
 HC
 HD
 HE
 HF
 HG
 HH
 HI
 HJ
 HK
 HL
 HM
 HN
 HO
 HP
 HQ
 HR
 HS
 HT
 HU
 HV
 HW
 HX
 HY
 HZ
 IA
 IB
 IC
 ID
 IE
 IF
 IG
 IH
 II
 IJ
 IK
 IL
 IM
 IN
 IO
 IP
 IQ
 IR
 IS
 IT
 IU
 IV
 IW
 IX
 IY
 IZ
 JA
 JB
 JC
 JD
 JE
 JF
 JG
 JH
 JI
 JJ
 JK
 JL
 JM
 JN
 JO
 JP
 JQ
 JR
 JS
 JT
 JU
 JV
 JW
 JX
 JY
 JZ
 KA
 KB
 KC
 KD
 KE
 KF
 KG
 KH
 KI
 KJ
 KK
 KL
 KM
 KN
 KO
 KP
 KQ
 KR
 KS
 KT
 KU
 KV
 KW
 KX
 KY
 KZ
 LA
 LB
 LC
 LD
 LE
 LF
 LG
 LH
 LI
 LJ
 LK
 LL
 LM
 LN
 LO
 LP
 LQ
 LR
 LS
 LT
 LU
 LV
 LW
 LX
 LY
 LZ
 MA
 MB
 MC
 MD
 ME
 MF
 MG
 MH
 MI
 MJ
 MK
 ML
 MM
 MN
 MO
 MP
 MQ
 MR
 MS
 MT
 MU
 MV
 MW
 MX
 MY
 MZ
 NA
 NB
 NC
 ND
 NE
 NF
 NG
 NH
 NI
 NJ
 NK
 NL
 NM
 NN
 NO
 NP
 NQ
 NR
 NS
 NT
 NU
 NV
 NW
 NX
 NY
 NZ
 OA
 OB
 OC
 OD
 OE
 OF
 OG
 OH
 OI
 OJ
 OK
 OL
 OM
 ON
 OO
 OP
 OQ
 OR
 OS
 OT
 OU
 OV
 OW
 OX
 OY
 OZ
 PA
 PB
 PC
 PD
 PE
 PF
 PG
 PH
 PI
 PJ
 PK
 PL
 PM
 PN
 PO
 PP
 PQ
 PR
 PS
 PT
 PU
 PV
 PW
 PX
 PY
 PZ
 QA
 QB
 QC
 QD
 QE
 QF
 QG
 QH
 QI
 QJ
 QK
 QL
 QM
 QN
 QO
 QP
 QQ
 QR
 QS
 QT
 QU
 QV
 QW
 QX
 QY
 QZ
 RA
 RB
 RC
 RD
 RE
 RF
 RG
 RH
 RI
 RJ
 RK
 RL
 RM
 RN
 RO
 RP
 RQ
 RR
 RS
 RT
 RU
 RV
 RW
 RX
 RY
 RZ
 SA
 SB
 SC
 SD
 SE
 SF
 SG
 SH
 SI
 SJ
 SK
 SL
 SM
 SN
 SO
 SP
 SQ
 SR
 SS
 ST
 SU
 SV
 SW
 SX
 SY
 SZ
 TA
 TB
 TC
 TD
 TE
 TF
 TG
 TH
 TI
 TJ
 TK
 TL
 TM
 TN
 TO
 TP
 TQ
 TR
 TS
 TT
 TU
 TV
 TW
 TX
 TY
 TZ
 UA
 UB
 UC
 UD
 UE
 UF
 UG
 UH
 UI
 UJ
 UK
 UL
 UM
 UN
 UO
 UP
 UQ
 UR
 US
 UT
 UU
 UV
 UW
 UX
 UY
 UZ
 VA
 VB
 VC
 VD
 VE
 VF
 VG
 VH
 VI
 VJ
 VK
 VL
 VM
 VN
 VO
 VP
 VQ
 VR
 VS
 VT
 VU
 VV
 VW
 VX
 VY
 VZ
 WA
 WB
 WC
 WD
 WE
 WF
 WG
 WH
 WI
 WJ
 WK
 WL
 WM
 WN
 WO
 WP
 WQ
 WR
 WS
 WT
 WU
 WV
 WW
 WX
 WY
 WZ
 XA
 XB
 XC
 XD
 XE
 XF
 XG
 XH
 XI
 XJ
 XK
 XL
 XM
 XN
 XO
 XP
 XQ
 XR
 XS
 XT
 XU
 XV
 XW
 XX
 XY
 XZ
 YA
 YB
 YC
 YD
 YE
 YF
 YG
 YH
 YI
 YJ
 YK
 YL
 YM
 YN
 YO
 YP
 YQ
 YR
 YS
 YT
 YU
 YV
 YW
 YX
 YY
 YZ
 ZA
 ZB
 ZC
 ZD
 ZE
 ZF
 ZG
 ZH
 ZI
 ZJ
 ZK
 ZL
 ZM
 ZN
 ZO
 ZP
 ZQ
 ZR
 ZS
 ZT
 ZU
 ZV
 ZW
 ZX
 ZY
 ZZ

Zahnzangen, amerikanische Modelle
 Extracting forceps, american pattern
 Fórceps de extracción, forma americana
 Daviers, modèle américaine
 Pinza per estrazione, modello americano



HARRIS
 Fig. 18L
 PB 018/05



HARRIS
 Fig. 18R
 PB 018/08

ZAHNZANGEN EXTRACTING FORCEPS FORCEPS DE EXTRACCION DAVIERS PINZA PER ESTRAZIONE

Zahnzangen, amerikanische Modelle
 Extracting forceps, american pattern
 Fórceps de extracción, forma americana
 Daviers, modèle américaine
 Pinza per estrazione, modello americano



Fig.23
 PB 023/00



Fig.24
 PB 024/00

AA
 AB
 AC
 AD
 AE
 AF
 AK
 AL
 AO
 AR
 KA
 KL
 KU
 PA
PB
 PF
 PI
 PK
 PL
 PM
 PP
 PS
 PT
 PU
 PV
 KYE

Zahnzangen, amerikanische Modelle
 Extracting forceps, american pattern
 Fórceps de extracción, forma americana
 Daviers, modèle américaine
 Pinza per estrazione, modello americano



PARMLY
 Fig.32
 PB 032/00



PARMLY
 Fig.32A
 PB 032/01

ZAHNZANGEN EXTRACTING FORCEPS FORCEPS DE EXTRACCION DAVIERS PINZA PER ESTRAZIONE

Zahnzangen, amerikanische Modelle
 Extracting forceps, american pattern
 Fórceps de extracción, forma americana
 Daviers, modèle américaine
 Pinza per estrazione, modello americano



Fig.53L
 PB 053/05



Fig.53R
 PB 053/08

AA
 AB
 AC
 AD
 AE
 AF
 AG
 AH
 AI
 AJ
 AK
 AL
 AO
 AP
 AQ
 AR
 AS
 AT
 AU
 AV
 AW
 AX
 AY
 AZ
 BA
 BB
 BC
 BD
 BE
 BF
 BG
 BH
 BI
 BJ
 BK
 BL
 BM
 BN
 BO
 BP
 BQ
 BR
 BS
 BT
 BU
 BV
 BW
 BX
 BY
 BZ
 CA
 CB
 CC
 CD
 CE
 CF
 CG
 CH
 CI
 CJ
 CK
 CL
 CM
 CN
 CO
 CP
 CQ
 CR
 CS
 CT
 CU
 CV
 CW
 CX
 CY
 CZ
 DA
 DB
 DC
 DD
 DE
 DF
 DG
 DH
 DI
 DJ
 DK
 DL
 DM
 DN
 DO
 DP
 DQ
 DR
 DS
 DT
 DU
 DV
 DW
 DX
 DY
 DZ
 EA
 EB
 EC
 ED
 EE
 EF
 EG
 EH
 EI
 EJ
 EK
 EL
 EM
 EN
 EO
 EP
 EQ
 ER
 ES
 ET
 EU
 EV
 EW
 EX
 EY
 EZ
 FA
 FB
 FC
 FD
 FE
 FF
 FG
 FH
 FI
 FJ
 FK
 FL
 FM
 FN
 FO
 FP
 FQ
 FR
 FS
 FT
 FU
 FV
 FW
 FX
 FY
 FZ
 GA
 GB
 GC
 GD
 GE
 GF
 GG
 GH
 GI
 GJ
 GK
 GL
 GM
 GN
 GO
 GP
 GQ
 GR
 GS
 GT
 GU
 GV
 GW
 GX
 GY
 GZ
 HA
 HB
 HC
 HD
 HE
 HF
 HG
 HH
 HI
 HJ
 HK
 HL
 HM
 HN
 HO
 HP
 HQ
 HR
 HS
 HT
 HU
 HV
 HW
 HX
 HY
 HZ
 IA
 IB
 IC
 ID
 IE
 IF
 IG
 IH
 II
 IJ
 IK
 IL
 IM
 IN
 IO
 IP
 IQ
 IR
 IS
 IT
 IU
 IV
 IW
 IX
 IY
 IZ
 JA
 JB
 JC
 JD
 JE
 JF
 JG
 JH
 JI
 JJ
 JK
 JL
 JM
 JN
 JO
 JP
 JQ
 JR
 JS
 JT
 JU
 JV
 JW
 JX
 JY
 JZ
 KA
 KB
 KC
 KD
 KE
 KF
 KG
 KH
 KI
 KJ
 KK
 KL
 KM
 KN
 KO
 KP
 KQ
 KR
 KS
 KT
 KU
 KV
 KW
 KX
 KY
 KZ
 LA
 LB
 LC
 LD
 LE
 LF
 LG
 LH
 LI
 LJ
 LK
 LL
 LM
 LN
 LO
 LP
 LQ
 LR
 LS
 LT
 LU
 LV
 LW
 LX
 LY
 LZ
 MA
 MB
 MC
 MD
 ME
 MF
 MG
 MH
 MI
 MJ
 MK
 ML
 MM
 MN
 MO
 MP
 MQ
 MR
 MS
 MT
 MU
 MV
 MW
 MX
 MY
 MZ
 NA
 NB
 NC
 ND
 NE
 NF
 NG
 NH
 NI
 NJ
 NK
 NL
 NM
 NN
 NO
 NP
 NQ
 NR
 NS
 NT
 NU
 NV
 NW
 NX
 NY
 NZ
 OA
 OB
 OC
 OD
 OE
 OF
 OG
 OH
 OI
 OJ
 OK
 OL
 OM
 ON
 OO
 OP
 OQ
 OR
 OS
 OT
 OU
 OV
 OW
 OX
 OY
 OZ
 PA
 PB
 PC
 PD
 PE
 PF
 PG
 PH
 PI
 PJ
 PK
 PL
 PM
 PN
 PO
 PP
 PQ
 PR
 PS
 PT
 PU
 PV
 PW
 PX
 PY
 PZ
 QA
 QB
 QC
 QD
 QE
 QF
 QG
 QH
 QI
 QJ
 QK
 QL
 QM
 QN
 QO
 QP
 QQ
 QR
 QS
 QT
 QU
 QV
 QW
 QX
 QY
 QZ
 RA
 RB
 RC
 RD
 RE
 RF
 RG
 RH
 RI
 RJ
 RK
 RL
 RM
 RN
 RO
 RP
 RQ
 RR
 RS
 RT
 RU
 RV
 RW
 RX
 RY
 RZ
 SA
 SB
 SC
 SD
 SE
 SF
 SG
 SH
 SI
 SJ
 SK
 SL
 SM
 SN
 SO
 SP
 SQ
 SR
 SS
 ST
 SU
 SV
 SW
 SX
 SY
 SZ
 TA
 TB
 TC
 TD
 TE
 TF
 TG
 TH
 TI
 TJ
 TK
 TL
 TM
 TN
 TO
 TP
 TQ
 TR
 TS
 TT
 TU
 TV
 TW
 TX
 TY
 TZ
 UA
 UB
 UC
 UD
 UE
 UF
 UG
 UH
 UI
 UJ
 UK
 UL
 UM
 UN
 UO
 UP
 UQ
 UR
 US
 UT
 UY
 UZ
 VA
 VB
 VC
 VD
 VE
 VF
 VG
 VH
 VI
 VJ
 VK
 VL
 VM
 VN
 VO
 VP
 VQ
 VR
 VS
 VT
 VU
 VV
 VW
 VX
 VY
 VZ
 WA
 WB
 WC
 WD
 WE
 WF
 WG
 WH
 WI
 WJ
 WK
 WL
 WM
 WN
 WO
 WP
 WQ
 WR
 WS
 WT
 WU
 WV
 WW
 WX
 WY
 WZ
 XA
 XB
 XC
 XD
 XE
 XF
 XG
 XH
 XI
 XJ
 XK
 XL
 XM
 XN
 XO
 XP
 XQ
 XR
 XS
 XT
 XU
 XV
 XW
 XX
 XY
 XZ
 YA
 YB
 YC
 YD
 YE
 YF
 YG
 YH
 YI
 YJ
 YK
 YL
 YM
 YN
 YO
 YP
 YQ
 YR
 YS
 YT
 YU
 YV
 YW
 YX
 YZ
 ZA
 ZB
 ZC
 ZD
 ZE
 ZF
 ZG
 ZH
 ZI
 ZJ
 ZK
 ZL
 ZM
 ZN
 ZO
 ZP
 ZQ
 ZR
 ZS
 ZT
 ZU
 ZV
 ZW
 ZX
 ZY
 ZZ

Zahnzangen, amerikanische Modelle
 Extracting forceps, american pattern
 Fórceps de extracción, forma americana
 Daviers, modèle américaine
 Pinza per estrazione, modello americano



Fig.62
 PB 062/00

Fig.65
 PB 065/00

TOMES
 Fig.69
 PB 069/00

ZAHNZANGEN EXTRACTING FORCEPS FORCEPS DE EXTRACCION DAVIERS PINZA PER ESTRAZIONE

Zahnzangen, amerikanische Modelle
 Extracting forceps, american pattern
 Fórceps de extracción, forma americana
 Daviers, modèle américaine
 Pinza per estrazione, modello americano



NEVIUS
 Fig.88L
 PB 088/05



NEVIUS
 Fig.88R
 PB 088/08

AA
 AB
 AC
 AD
 AE
 AF
 AK
 AL
 AO
 AR
 KA
 KL
 KU
 PA
PB
 PF
 PI
 PK
 PL
 PM
 PP
 PS
 PT
 PU
 PV
 KYE

Zahnzangen, amerikanische Modelle
 Extracting forceps, american pattern
 Fórceps de extracción, forma americana
 Daviers, modèle américaine
 Pinza per estrazione, modello americano



CRYER
 Fig. 150
 PB 150/00



CRYER
 Fig. 150A
 PB 150/01



Fig. 150X
 PB 150/02

ZAHNZANGEN EXTRACTING FORCEPS FORCEPS DE EXTRACCION DAVIERS PINZA PER ESTRAZIONE

Zahnzangen, amerikanische Modelle
 Extracting forceps, american pattern
 Fórceps de extracción, forma americana
 Daviers, modèle américaine
 Pinza per estrazione, modello americano



Fig. 150AS
 PB 150/03



Fig. 150S
 PB 150/09

AA
 AB
 AC
 AD
 AE
 AF
 AG
 AH
 AI
 AJ
 AK
 AL
 AO
 AP
 AQ
 AR
 AS
 AT
 AU
 AV
 AW
 AX
 AY
 AZ
 BA
 BB
 BC
 BD
 BE
 BF
 BG
 BH
 BI
 BJ
 BK
 BL
 BM
 BN
 BO
 BP
 BQ
 BR
 BS
 BT
 BU
 BV
 BW
 BX
 BY
 BZ
 CA
 CB
 CC
 CD
 CE
 CF
 CG
 CH
 CI
 CJ
 CK
 CL
 CM
 CN
 CO
 CP
 CQ
 CR
 CS
 CT
 CU
 CV
 CW
 CX
 CY
 CZ
 DA
 DB
 DC
 DD
 DE
 DF
 DG
 DH
 DI
 DJ
 DK
 DL
 DM
 DN
 DO
 DP
 DQ
 DR
 DS
 DT
 DU
 DV
 DW
 DX
 DY
 DZ
 EA
 EB
 EC
 ED
 EE
 EF
 EG
 EH
 EI
 EJ
 EK
 EL
 EM
 EN
 EO
 EP
 EQ
 ER
 ES
 ET
 EU
 EV
 EW
 EX
 EY
 EZ
 FA
 FB
 FC
 FD
 FE
 FF
 FG
 FH
 FI
 FJ
 FK
 FL
 FM
 FN
 FO
 FP
 FQ
 FR
 FS
 FT
 FU
 FV
 FW
 FX
 FY
 FZ
 GA
 GB
 GC
 GD
 GE
 GF
 GG
 GH
 GI
 GJ
 GK
 GL
 GM
 GN
 GO
 GP
 GQ
 GR
 GS
 GT
 GU
 GV
 GW
 GX
 GY
 GZ
 HA
 HB
 HC
 HD
 HE
 HF
 HG
 HH
 HI
 HJ
 HK
 HL
 HM
 HN
 HO
 HP
 HQ
 HR
 HS
 HT
 HU
 HV
 HW
 HX
 HY
 HZ
 IA
 IB
 IC
 ID
 IE
 IF
 IG
 IH
 II
 IJ
 IK
 IL
 IM
 IN
 IO
 IP
 IQ
 IR
 IS
 IT
 IU
 IV
 IW
 IX
 IY
 IZ
 JA
 JB
 JC
 JD
 JE
 JF
 JG
 JH
 JI
 JJ
 JK
 JL
 JM
 JN
 JO
 JP
 JQ
 JR
 JS
 JT
 JU
 JV
 JW
 JX
 JY
 JZ
 KA
 KB
 KC
 KD
 KE
 KF
 KG
 KH
 KI
 KJ
 KK
 KL
 KM
 KN
 KO
 KP
 KQ
 KR
 KS
 KT
 KU
 KV
 KW
 KX
 KY
 KZ
 LA
 LB
 LC
 LD
 LE
 LF
 LG
 LH
 LI
 LJ
 LK
 LL
 LM
 LN
 LO
 LP
 LQ
 LR
 LS
 LT
 LU
 LV
 LW
 LX
 LY
 LZ
 MA
 MB
 MC
 MD
 ME
 MF
 MG
 MH
 MI
 MJ
 MK
 ML
 MM
 MN
 MO
 MP
 MQ
 MR
 MS
 MT
 MU
 MV
 MW
 MX
 MY
 MZ
 NA
 NB
 NC
 ND
 NE
 NF
 NG
 NH
 NI
 NJ
 NK
 NL
 NM
 NN
 NO
 NP
 NQ
 NR
 NS
 NT
 NU
 NV
 NW
 NX
 NY
 NZ
 OA
 OB
 OC
 OD
 OE
 OF
 OG
 OH
 OI
 OJ
 OK
 OL
 OM
 ON
 OO
 OP
 OQ
 OR
 OS
 OT
 OU
 OV
 OW
 OX
 OY
 OZ
 PA
 PB
 PC
 PD
 PE
 PF
 PG
 PH
 PI
 PJ
 PK
 PL
 PM
 PN
 PO
 PP
 PQ
 PR
 PS
 PT
 PU
 PV
 PW
 PX
 PY
 PZ
 QA
 QB
 QC
 QD
 QE
 QF
 QG
 QH
 QI
 QJ
 QK
 QL
 QM
 QN
 QO
 QP
 QQ
 QR
 QS
 QT
 QU
 QV
 QW
 QX
 QY
 QZ
 RA
 RB
 RC
 RD
 RE
 RF
 RG
 RH
 RI
 RJ
 RK
 RL
 RM
 RN
 RO
 RP
 RQ
 RR
 RS
 RT
 RU
 RV
 RW
 RX
 RY
 RZ
 SA
 SB
 SC
 SD
 SE
 SF
 SG
 SH
 SI
 SJ
 SK
 SL
 SM
 SN
 SO
 SP
 SQ
 SR
 SS
 ST
 SU
 SV
 SW
 SX
 SY
 SZ
 TA
 TB
 TC
 TD
 TE
 TF
 TG
 TH
 TI
 TJ
 TK
 TL
 TM
 TN
 TO
 TP
 TQ
 TR
 TS
 TT
 TU
 TV
 TW
 TX
 TY
 TZ
 UA
 UB
 UC
 UD
 UE
 UF
 UG
 UH
 UI
 UJ
 UK
 UL
 UM
 UN
 UO
 UP
 UQ
 UR
 US
 UT
 UY
 UZ
 VA
 VB
 VC
 VD
 VE
 VF
 VG
 VH
 VI
 VJ
 VK
 VL
 VM
 VN
 VO
 VP
 VQ
 VR
 VS
 VT
 VU
 VV
 VW
 VX
 VY
 VZ
 WA
 WB
 WC
 WD
 WE
 WF
 WG
 WH
 WI
 WJ
 WK
 WL
 WM
 WN
 WO
 WP
 WQ
 WR
 WS
 WT
 WU
 WV
 WW
 WX
 WY
 WZ
 XA
 XB
 XC
 XD
 XE
 XF
 XG
 XH
 XI
 XJ
 XK
 XL
 XM
 XN
 XO
 XP
 XQ
 XR
 XS
 XT
 XU
 XV
 XW
 XX
 XY
 XZ
 YA
 YB
 YC
 YD
 YE
 YF
 YG
 YH
 YI
 YJ
 YK
 YL
 YM
 YN
 YO
 YP
 YQ
 YR
 YS
 YT
 YU
 YV
 YW
 YX
 YZ
 ZA
 ZB
 ZC
 ZD
 ZE
 ZF
 ZG
 ZH
 ZI
 ZJ
 ZK
 ZL
 ZM
 ZN
 ZO
 ZP
 ZQ
 ZR
 ZS
 ZT
 ZU
 ZV
 ZW
 ZX
 ZY
 ZZ

Zahnzangen, amerikanische Modelle
 Extracting forceps, american pattern
 Fórceps de extracción, forma americana
 Daviers, modèle américaine
 Pinza per estrazione, modello americano



CRYER
 Fig.151
 PB 151/00



CRYER
 Fig.151A
 PB 151/01



CRYER
 Fig.151X
 PB 151/02

ZAHNZANGEN EXTRACTING FORCEPS FORCEPS DE EXTRACCION DAVIERS PINZA PER ESTRAZIONE

Zahnzangen, amerikanische Modelle
 Extracting forceps, american pattern
 Fórceps de extracción, forma americana
 Daviers, modèle américaine
 Pinza per estrazione, modello americano



Fig. 151AS
 PB 151/08



CRYER
 Fig. 151S
 PB 151/09

AA
 AB
 AC
 AD
 AE
 AF
 AG
 AH
 AI
 AJ
 AK
 AL
 AO
 AP
 AQ
 AR
 AS
 AT
 AU
 AV
 AW
 AX
 AY
 AZ
 BA
 BB
 BC
 BD
 BE
 BF
 BG
 BH
 BI
 BJ
 BK
 BL
 BM
 BN
 BO
 BP
 BQ
 BR
 BS
 BT
 BU
 BV
 BW
 BX
 BY
 BZ
 CA
 CB
 CC
 CD
 CE
 CF
 CG
 CH
 CI
 CJ
 CK
 CL
 CM
 CN
 CO
 CP
 CQ
 CR
 CS
 CT
 CU
 CV
 CW
 CX
 CY
 CZ
 DA
 DB
 DC
 DD
 DE
 DF
 DG
 DH
 DI
 DJ
 DK
 DL
 DM
 DN
 DO
 DP
 DQ
 DR
 DS
 DT
 DU
 DV
 DW
 DX
 DY
 DZ
 EA
 EB
 EC
 ED
 EE
 EF
 EG
 EH
 EI
 EJ
 EK
 EL
 EM
 EN
 EO
 EP
 EQ
 ER
 ES
 ET
 EU
 EV
 EW
 EX
 EY
 EZ
 FA
 FB
 FC
 FD
 FE
 FF
 FG
 FH
 FI
 FJ
 FK
 FL
 FM
 FN
 FO
 FP
 FQ
 FR
 FS
 FT
 FU
 FV
 FW
 FX
 FY
 FZ
 GA
 GB
 GC
 GD
 GE
 GF
 GG
 GH
 GI
 GJ
 GK
 GL
 GM
 GN
 GO
 GP
 GQ
 GR
 GS
 GT
 GU
 GV
 GW
 GX
 GY
 GZ
 HA
 HB
 HC
 HD
 HE
 HF
 HG
 HH
 HI
 HJ
 HK
 HL
 HM
 HN
 HO
 HP
 HQ
 HR
 HS
 HT
 HU
 HV
 HW
 HX
 HY
 HZ
 IA
 IB
 IC
 ID
 IE
 IF
 IG
 IH
 II
 IJ
 IK
 IL
 IM
 IN
 IO
 IP
 IQ
 IR
 IS
 IT
 IU
 IV
 IW
 IX
 IY
 IZ
 JA
 JB
 JC
 JD
 JE
 JF
 JG
 JH
 JI
 JJ
 JK
 JL
 JM
 JN
 JO
 JP
 JQ
 JR
 JS
 JT
 JU
 JV
 JW
 JX
 JY
 JZ
 KA
 KB
 KC
 KD
 KE
 KF
 KG
 KH
 KI
 KJ
 KK
 KL
 KM
 KN
 KO
 KP
 KQ
 KR
 KS
 KT
 KU
 KV
 KW
 KX
 KY
 KZ
 LA
 LB
 LC
 LD
 LE
 LF
 LG
 LH
 LI
 LJ
 LK
 LL
 LM
 LN
 LO
 LP
 LQ
 LR
 LS
 LT
 LU
 LV
 LW
 LX
 LY
 LZ
 MA
 MB
 MC
 MD
 ME
 MF
 MG
 MH
 MI
 MJ
 MK
 ML
 MM
 MN
 MO
 MP
 MQ
 MR
 MS
 MT
 MU
 MV
 MW
 MX
 MY
 MZ
 NA
 NB
 NC
 ND
 NE
 NF
 NG
 NH
 NI
 NJ
 NK
 NL
 NM
 NN
 NO
 NP
 NQ
 NR
 NS
 NT
 NU
 NV
 NW
 NX
 NY
 NZ
 OA
 OB
 OC
 OD
 OE
 OF
 OG
 OH
 OI
 OJ
 OK
 OL
 OM
 ON
 OO
 OP
 OQ
 OR
 OS
 OT
 OU
 OV
 OW
 OX
 OY
 OZ
 PA
 PB
 PC
 PD
 PE
 PF
 PG
 PH
 PI
 PJ
 PK
 PL
 PM
 PN
 PO
 PP
 PQ
 PR
 PS
 PT
 PU
 PV
 PW
 PX
 PY
 PZ
 QA
 QB
 QC
 QD
 QE
 QF
 QG
 QH
 QI
 QJ
 QK
 QL
 QM
 QN
 QO
 QP
 QQ
 QR
 QS
 QT
 QU
 QV
 QW
 QX
 QY
 QZ
 RA
 RB
 RC
 RD
 RE
 RF
 RG
 RH
 RI
 RJ
 RK
 RL
 RM
 RN
 RO
 RP
 RQ
 RR
 RS
 RT
 RU
 RV
 RW
 RX
 RY
 RZ
 SA
 SB
 SC
 SD
 SE
 SF
 SG
 SH
 SI
 SJ
 SK
 SL
 SM
 SN
 SO
 SP
 SQ
 SR
 SS
 ST
 SU
 SV
 SW
 SX
 SY
 SZ
 TA
 TB
 TC
 TD
 TE
 TF
 TG
 TH
 TI
 TJ
 TK
 TL
 TM
 TN
 TO
 TP
 TQ
 TR
 TS
 TT
 TU
 TV
 TW
 TX
 TY
 TZ
 UA
 UB
 UC
 UD
 UE
 UF
 UG
 UH
 UI
 UJ
 UK
 UL
 UM
 UN
 UO
 UP
 UQ
 UR
 US
 UT
 UU
 UV
 UW
 UX
 UY
 UZ
 VA
 VB
 VC
 VD
 VE
 VF
 VG
 VH
 VI
 VJ
 VK
 VL
 VM
 VN
 VO
 VP
 VQ
 VR
 VS
 VT
 VU
 VV
 VW
 VX
 VY
 VZ
 WA
 WB
 WC
 WD
 WE
 WF
 WG
 WH
 WI
 WJ
 WK
 WL
 WM
 WN
 WO
 WP
 WQ
 WR
 WS
 WT
 WU
 WV
 WW
 WX
 WY
 WZ
 XA
 XB
 XC
 XD
 XE
 XF
 XG
 XH
 XI
 XJ
 XK
 XL
 XM
 XN
 XO
 XP
 XQ
 XR
 XS
 XT
 XU
 XV
 XW
 XX
 XY
 XZ
 YA
 YB
 YC
 YD
 YE
 YF
 YG
 YH
 YI
 YJ
 YK
 YL
 YM
 YN
 YO
 YP
 YQ
 YR
 YS
 YT
 YU
 YV
 YW
 YX
 YZ
 ZA
 ZB
 ZC
 ZD
 ZE
 ZF
 ZG
 ZH
 ZI
 ZJ
 ZK
 ZL
 ZM
 ZN
 ZO
 ZP
 ZQ
 ZR
 ZS
 ZT
 ZU
 ZV
 ZW
 ZX
 ZY
 ZZ

Zahnzangen, amerikanische Modelle
 Extracting forceps, american pattern
 Fórceps de extracción, forma americana
 Daviers, modèle américaine
 Pinza per estrazione, modello americano



KELLS
 Fig.99C
 PB 199/03



Fig.210H
 PB 210/04



Fig.222
 PB 222/00

ZAHNZANGEN EXTRACTING FORCEPS FORCEPS DE EXTRACCION DAVIERS PINZA PER ESTRAZIONE

Kinderzahnzangen, amerikanische Modelle
 Extracting forceps for children, american pattern
 Fórceps de extracción para niños, forma americana
 Daviers pour enfants, modèle américaine
 Pinze per estrazione per bambini, modello americano



Fig.17SK
 PB 517/09



Fig.23SK
 PB 523/09

AA
 AB
 AC
 AD
 AE
 AF
 AK
 AL
 AO
 AR
 KA
 KL
 KU
 PA
PB
 PF
 PI
 PK
 PL
 PM
 PP
 PS
 PT
 PU
 PV
 KYE

Kinderzahnzangen, amerikanische Modelle
 Extracting forceps for children, american pattern
 Fórceps de extracción para niños, forma americana
 Daviers pour enfants, modèle américaine
 Pinze per estrazione per bambini, modello americano



Fig.150 SK
 PB 550/09



Fig.151 SK
 PB 551/09

WURZELHEBER
ROOT ELEVATORS
ELEVADORES PARA RAICES
ELEVATEURS A RACINES
ELEVATORI PER RADICI

PF

nopa[®] instruments



Wurzelheber
 Root elevators
 Elevadores para raíces
 Elevateurs à racines
 Elevatori per radici



FLOHR
 15,0 cm/6"



Fig.1
 PF 001/01



Fig.2
 PF 001/02



Fig.3
 PF 001/03

AA
 AB
 AC
 AD
 AE
 AF
 AG
 AH
 AI
 AJ
 AK
 AL
 AM
 AN
 AO
 AP
 AQ
 AR
 AS
 AT
 AU
 AV
 AW
 AX
 AY
 AZ
 BA
 BB
 BC
 BD
 BE
 BF
 BG
 BH
 BI
 BJ
 BK
 BL
 BM
 BN
 BO
 BP
 BQ
 BR
 BS
 BT
 BU
 BV
 BW
 BX
 BY
 BZ
 CA
 CB
 CC
 CD
 CE
 CF
 CG
 CH
 CI
 CJ
 CK
 CL
 CM
 CN
 CO
 CP
 CQ
 CR
 CS
 CT
 CU
 CV
 CW
 CX
 CY
 CZ
 DA
 DB
 DC
 DD
 DE
 DF
 DG
 DH
 DI
 DJ
 DK
 DL
 DM
 DN
 DO
 DP
 DQ
 DR
 DS
 DT
 DU
 DV
 DW
 DX
 DY
 DZ
 EA
 EB
 EC
 ED
 EE
 EF
 EG
 EH
 EI
 EJ
 EK
 EL
 EM
 EN
 EO
 EP
 EQ
 ER
 ES
 ET
 EU
 EV
 EW
 EX
 EY
 EZ
 FA
 FB
 FC
 FD
 FE
 FF
 FG
 FH
 FI
 FJ
 FK
 FL
 FM
 FN
 FO
 FP
 FQ
 FR
 FS
 FT
 FU
 FV
 FW
 FX
 FY
 FZ
 GA
 GB
 GC
 GD
 GE
 GF
 GG
 GH
 GI
 GJ
 GK
 GL
 GM
 GN
 GO
 GP
 GQ
 GR
 GS
 GT
 GU
 GV
 GW
 GX
 GY
 GZ
 HA
 HB
 HC
 HD
 HE
 HF
 HG
 HH
 HI
 HJ
 HK
 HL
 HM
 HN
 HO
 HP
 HQ
 HR
 HS
 HT
 HU
 HV
 HW
 HX
 HY
 HZ
 IA
 IB
 IC
 ID
 IE
 IF
 IG
 IH
 II
 IJ
 IK
 IL
 IM
 IN
 IO
 IP
 IQ
 IR
 IS
 IT
 IU
 IV
 IW
 IX
 IY
 IZ
 JA
 JB
 JC
 JD
 JE
 JF
 JG
 JH
 JI
 JJ
 JK
 JL
 JM
 JN
 JO
 JP
 JQ
 JR
 JS
 JT
 JU
 JV
 JW
 JX
 JY
 JZ
 KA
 KB
 KC
 KD
 KE
 KF
 KG
 KH
 KI
 KJ
 KK
 KL
 KM
 KN
 KO
 KP
 KQ
 KR
 KS
 KT
 KU
 KV
 KW
 KX
 KY
 KZ
 LA
 LB
 LC
 LD
 LE
 LF
 LG
 LH
 LI
 LJ
 LK
 LL
 LM
 LN
 LO
 LP
 LQ
 LR
 LS
 LT
 LU
 LV
 LW
 LX
 LY
 LZ
 MA
 MB
 MC
 MD
 ME
 MF
 MG
 MH
 MI
 MJ
 MK
 ML
 MM
 MN
 MO
 MP
 MQ
 MR
 MS
 MT
 MU
 MV
 MW
 MX
 MY
 MZ
 NA
 NB
 NC
 ND
 NE
 NF
 NG
 NH
 NI
 NJ
 NK
 NL
 NM
 NN
 NO
 NP
 NQ
 NR
 NS
 NT
 NU
 NV
 NW
 NX
 NY
 NZ
 OA
 OB
 OC
 OD
 OE
 OF
 OG
 OH
 OI
 OJ
 OK
 OL
 OM
 ON
 OO
 OP
 OQ
 OR
 OS
 OT
 OU
 OV
 OW
 OX
 OY
 OZ
 PA
 PB
 PC
 PD
 PE
 PF
 PG
 PH
 PI
 PJ
 PK
 PL
 PM
 PN
 PO
 PP
 PQ
 PR
 PS
 PT
 PU
 PV
 PW
 PX
 PY
 PZ
 QA
 QB
 QC
 QD
 QE
 QF
 QG
 QH
 QI
 QJ
 QK
 QL
 QM
 QN
 QO
 QP
 QQ
 QR
 QS
 QT
 QU
 QV
 QW
 QX
 QY
 QZ
 RA
 RB
 RC
 RD
 RE
 RF
 RG
 RH
 RI
 RJ
 RK
 RL
 RM
 RN
 RO
 RP
 RQ
 RR
 RS
 RT
 RU
 RV
 RW
 RX
 RY
 RZ
 SA
 SB
 SC
 SD
 SE
 SF
 SG
 SH
 SI
 SJ
 SK
 SL
 SM
 SN
 SO
 SP
 SQ
 SR
 SS
 ST
 SU
 SV
 SW
 SX
 SY
 SZ
 TA
 TB
 TC
 TD
 TE
 TF
 TG
 TH
 TI
 TJ
 TK
 TL
 TM
 TN
 TO
 TP
 TQ
 TR
 TS
 TT
 TU
 TV
 TW
 TX
 TY
 TZ
 UA
 UB
 UC
 UD
 UE
 UF
 UG
 UH
 UI
 UJ
 UK
 UL
 UM
 UN
 UO
 UP
 UQ
 UR
 US
 UT
 UU
 UV
 UW
 UX
 UY
 UZ
 VA
 VB
 VC
 VD
 VE
 VF
 VG
 VH
 VI
 VJ
 VK
 VL
 VM
 VN
 VO
 VP
 VQ
 VR
 VS
 VT
 VU
 VV
 VW
 VX
 VY
 VZ
 WA
 WB
 WC
 WD
 WE
 WF
 WG
 WH
 WI
 WJ
 WK
 WL
 WM
 WN
 WO
 WP
 WQ
 WR
 WS
 WT
 WU
 WV
 WW
 WX
 WY
 WZ
 XA
 XB
 XC
 XD
 XE
 XF
 XG
 XH
 XI
 XJ
 XK
 XL
 XM
 XN
 XO
 XP
 XQ
 XR
 XS
 XT
 XU
 XV
 XW
 XX
 XY
 XZ
 YA
 YB
 YC
 YD
 YE
 YF
 YG
 YH
 YI
 YJ
 YK
 YL
 YM
 YN
 YO
 YP
 YQ
 YR
 YS
 YT
 YU
 YV
 YW
 YX
 YZ
 ZA
 ZB
 ZC
 ZD
 ZE
 ZF
 ZG
 ZH
 ZI
 ZJ
 ZK
 ZL
 ZM
 ZN
 ZO
 ZP
 ZQ
 ZR
 ZS
 ZT
 ZU
 ZV
 ZW
 ZX
 ZY
 ZZ

Wurzelheber
 Root elevators
 Elevadores para raices
 Elevateurs à racines
 Elevatori per radici



CRYER
 15,0 cm/6"



Fig.3A
 PF 002/03

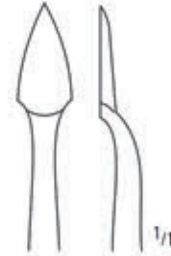

Fig.12
 PF 002/12



Fig.27
 PF 002/27



Fig.28
 PF 002/28



Fig.39
 PF 002/39



Fig.40
 PF 002/40

WURZELHEBER ROOT ELEVATORS ELEVADORES PARA RAICES ELEVATEURS A RACINES ELEVATORI PER RADICI

Wurzelheber
 Root elevators
 Elevadores para raíces
 Elevateurs à racines
 Elevatori per radici



APICAL
 15,0 cm/6"



Fig.2
 PF 003/02



Fig.3
 PF 003/03



Fig.4
 PF 003/04



Fig.1A
 PF 003/11



Fig.2A
 PF 003/12



Fig.3A
 PF 003/13



Fig.4A
 PF 003/14

AA
 AB
 AC
 AD
 AE
 AF
 AG
 AH
 AI
 AJ
 AK
 AL
 AM
 AN
 AO
 AP
 AQ
 AR
 AS
 AT
 AU
 AV
 AW
 AX
 AY
 AZ
 BA
 BB
 BC
 BD
 BE
 BF
 BG
 BH
 BI
 BJ
 BK
 BL
 BM
 BN
 BO
 BP
 BQ
 BR
 BS
 BT
 BU
 BV
 BW
 BX
 BY
 BZ
 CA
 CB
 CC
 CD
 CE
 CF
 CG
 CH
 CI
 CJ
 CK
 CL
 CM
 CN
 CO
 CP
 CQ
 CR
 CS
 CT
 CU
 CV
 CW
 CX
 CY
 CZ
 DA
 DB
 DC
 DD
 DE
 DF
 DG
 DH
 DI
 DJ
 DK
 DL
 DM
 DN
 DO
 DP
 DQ
 DR
 DS
 DT
 DU
 DV
 DW
 DX
 DY
 DZ
 EA
 EB
 EC
 ED
 EE
 EF
 EG
 EH
 EI
 EJ
 EK
 EL
 EM
 EN
 EO
 EP
 EQ
 ER
 ES
 ET
 EU
 EV
 EW
 EX
 EY
 EZ
 FA
 FB
 FC
 FD
 FE
 FF
 FG
 FH
 FI
 FJ
 FK
 FL
 FM
 FN
 FO
 FP
 FQ
 FR
 FS
 FT
 FU
 FV
 FW
 FX
 FY
 FZ
 GA
 GB
 GC
 GD
 GE
 GF
 GG
 GH
 GI
 GJ
 GK
 GL
 GM
 GN
 GO
 GP
 GQ
 GR
 GS
 GT
 GU
 GV
 GW
 GX
 GY
 GZ
 HA
 HB
 HC
 HD
 HE
 HF
 HG
 HH
 HI
 HJ
 HK
 HL
 HM
 HN
 HO
 HP
 HQ
 HR
 HS
 HT
 HU
 HV
 HW
 HX
 HY
 HZ
 IA
 IB
 IC
 ID
 IE
 IF
 IG
 IH
 II
 IJ
 IK
 IL
 IM
 IN
 IO
 IP
 IQ
 IR
 IS
 IT
 IU
 IV
 IW
 IX
 IY
 IZ
 JA
 JB
 JC
 JD
 JE
 JF
 JG
 JH
 JI
 JJ
 JK
 JL
 JM
 JN
 JO
 JP
 JQ
 JR
 JS
 JT
 JU
 JV
 JW
 JX
 JY
 JZ
 KA
 KB
 KC
 KD
 KE
 KF
 KG
 KH
 KI
 KJ
 KK
 KL
 KM
 KN
 KO
 KP
 KQ
 KR
 KS
 KT
 KU
 KV
 KW
 KX
 KY
 KZ
 LA
 LB
 LC
 LD
 LE
 LF
 LG
 LH
 LI
 LJ
 LK
 LL
 LM
 LN
 LO
 LP
 LQ
 LR
 LS
 LT
 LU
 LV
 LW
 LX
 LY
 LZ
 MA
 MB
 MC
 MD
 ME
 MF
 MG
 MH
 MI
 MJ
 MK
 ML
 MM
 MN
 MO
 MP
 MQ
 MR
 MS
 MT
 MU
 MV
 MW
 MX
 MY
 MZ
 NA
 NB
 NC
 ND
 NE
 NF
 NG
 NH
 NI
 NJ
 NK
 NL
 NM
 NN
 NO
 NP
 NQ
 NR
 NS
 NT
 NU
 NV
 NW
 NX
 NY
 NZ
 OA
 OB
 OC
 OD
 OE
 OF
 OG
 OH
 OI
 OJ
 OK
 OL
 OM
 ON
 OO
 OP
 OQ
 OR
 OS
 OT
 OU
 OV
 OW
 OX
 OY
 OZ
 PA
 PB
 PC
 PD
 PE
 PF
 PG
 PH
 PI
 PJ
 PK
 PL
 PM
 PN
 PO
 PP
 PQ
 PR
 PS
 PT
 PU
 PV
 PW
 PX
 PY
 PZ
 QA
 QB
 QC
 QD
 QE
 QF
 QG
 QH
 QI
 QJ
 QK
 QL
 QM
 QN
 QO
 QP
 QQ
 QR
 QS
 QT
 QU
 QV
 QW
 QX
 QY
 QZ
 RA
 RB
 RC
 RD
 RE
 RF
 RG
 RH
 RI
 RJ
 RK
 RL
 RM
 RN
 RO
 RP
 RQ
 RR
 RS
 RT
 RU
 RV
 RW
 RX
 RY
 RZ
 SA
 SB
 SC
 SD
 SE
 SF
 SG
 SH
 SI
 SJ
 SK
 SL
 SM
 SN
 SO
 SP
 SQ
 SR
 SS
 ST
 SU
 SV
 SW
 SX
 SY
 SZ
 TA
 TB
 TC
 TD
 TE
 TF
 TG
 TH
 TI
 TJ
 TK
 TL
 TM
 TN
 TO
 TP
 TQ
 TR
 TS
 TT
 TU
 TV
 TW
 TX
 TY
 TZ
 UA
 UB
 UC
 UD
 UE
 UF
 UG
 UH
 UI
 UJ
 UK
 UL
 UM
 UN
 UO
 UP
 UQ
 UR
 US
 UT
 UY
 UZ
 VA
 VB
 VC
 VD
 VE
 VF
 VG
 VH
 VI
 VJ
 VK
 VL
 VM
 VN
 VO
 VP
 VQ
 VR
 VS
 VT
 VU
 VV
 VW
 VX
 VY
 VZ
 WA
 WB
 WC
 WD
 WE
 WF
 WG
 WH
 WI
 WJ
 WK
 WL
 WM
 WN
 WO
 WP
 WQ
 WR
 WS
 WT
 WU
 WV
 WW
 WX
 WY
 WZ
 XA
 XB
 XC
 XD
 XE
 XF
 XG
 XH
 XI
 XJ
 XK
 XL
 XM
 XN
 XO
 XP
 XQ
 XR
 XS
 XT
 XU
 XV
 XW
 XX
 XY
 XZ
 YA
 YB
 YC
 YD
 YE
 YF
 YG
 YH
 YI
 YJ
 YK
 YL
 YM
 YN
 YO
 YP
 YQ
 YR
 YS
 YT
 YU
 YV
 YW
 YX
 YZ
 ZA
 ZB
 ZC
 ZD
 ZE
 ZF
 ZG
 ZH
 ZI
 ZJ
 ZK
 ZL
 ZM
 ZN
 ZO
 ZP
 ZQ
 ZR
 ZS
 ZT
 ZU
 ZV
 ZW
 ZX
 ZY
 ZZ

Wurzelheber
 Root elevators
 Elevadores para raices
 Elevateurs à racines
 Elevatori per radici



APICAL
 15,0 cm/6"



Fig.301
 PF 003/31



Fig.302
 PF 003/32

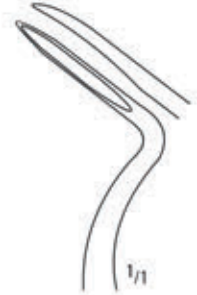

Fig.303
 PF 003/33



Fig.304
 PF 003/34

WURZELHEBER ROOT ELEVATORS ELEVADORES PARA RAICES ELEVATEURS A RACINES ELEVATORI PER RADICI

Wurzelheber
 Root elevators
 Elevadores para raíces
 Elevateurs à racines
 Elevatori per radici



SELDIN
 15,0 cm/6"



Fig.2
 PF 004/02



Fig.3
 PF 004/03



Fig.34
 PF 004/34



Fig.34S
 PF 004/35



Fig.301
 PF 004/36



Fig.77R
 PF 004/40



Fig.1L
 PF 005/01



Fig.1R
 PF 005/02



Fig.4L
 PF 007/01



Fig.4R
 PF 007/02

AA
 AB
 AC
 AD
 AE
 AF
 AG
 AH
 AI
 AJ
 AK
 AL
 AM
 AN
 AO
 AP
 AQ
 AR
 AS
 AT
 AU
 AV
 AW
 AX
 AY
 AZ
 BA
 BB
 BC
 BD
 BE
 BF
 BG
 BH
 BI
 BJ
 BK
 BL
 BM
 BN
 BO
 BP
 BQ
 BR
 BS
 BT
 BU
 BV
 BW
 BX
 BY
 BZ
 CA
 CB
 CC
 CD
 CE
 CF
 CG
 CH
 CI
 CJ
 CK
 CL
 CM
 CN
 CO
 CP
 CQ
 CR
 CS
 CT
 CU
 CV
 CW
 CX
 CY
 CZ
 DA
 DB
 DC
 DD
 DE
 DF
 DG
 DH
 DI
 DJ
 DK
 DL
 DM
 DN
 DO
 DP
 DQ
 DR
 DS
 DT
 DU
 DV
 DW
 DX
 DY
 DZ
 EA
 EB
 EC
 ED
 EE
 EF
 EG
 EH
 EI
 EJ
 EK
 EL
 EM
 EN
 EO
 EP
 EQ
 ER
 ES
 ET
 EU
 EV
 EW
 EX
 EY
 EZ
 FA
 FB
 FC
 FD
 FE
 FF
 FG
 FH
 FI
 FJ
 FK
 FL
 FM
 FN
 FO
 FP
 FQ
 FR
 FS
 FT
 FU
 FV
 FW
 FX
 FY
 FZ
 GA
 GB
 GC
 GD
 GE
 GF
 GG
 GH
 GI
 GJ
 GK
 GL
 GM
 GN
 GO
 GP
 GQ
 GR
 GS
 GT
 GU
 GV
 GW
 GX
 GY
 GZ
 HA
 HB
 HC
 HD
 HE
 HF
 HG
 HH
 HI
 HJ
 HK
 HL
 HM
 HN
 HO
 HP
 HQ
 HR
 HS
 HT
 HU
 HV
 HW
 HX
 HY
 HZ
 IA
 IB
 IC
 ID
 IE
 IF
 IG
 IH
 II
 IJ
 IK
 IL
 IM
 IN
 IO
 IP
 IQ
 IR
 IS
 IT
 IU
 IV
 IW
 IX
 IY
 IZ
 JA
 JB
 JC
 JD
 JE
 JF
 JG
 JH
 JI
 JJ
 JK
 JL
 JM
 JN
 JO
 JP
 JQ
 JR
 JS
 JT
 JU
 JV
 JW
 JX
 JY
 JZ
 KA
 KB
 KC
 KD
 KE
 KF
 KG
 KH
 KI
 KJ
 KK
 KL
 KM
 KN
 KO
 KP
 KQ
 KR
 KS
 KT
 KU
 KV
 KW
 KX
 KY
 KZ
 LA
 LB
 LC
 LD
 LE
 LF
 LG
 LH
 LI
 LJ
 LK
 LL
 LM
 LN
 LO
 LP
 LQ
 LR
 LS
 LT
 LU
 LV
 LW
 LX
 LY
 LZ
 MA
 MB
 MC
 MD
 ME
 MF
 MG
 MH
 MI
 MJ
 MK
 ML
 MM
 MN
 MO
 MP
 MQ
 MR
 MS
 MT
 MU
 MV
 MW
 MX
 MY
 MZ
 NA
 NB
 NC
 ND
 NE
 NF
 NG
 NH
 NI
 NJ
 NK
 NL
 NM
 NN
 NO
 NP
 NQ
 NR
 NS
 NT
 NU
 NV
 NW
 NX
 NY
 NZ
 OA
 OB
 OC
 OD
 OE
 OF
 OG
 OH
 OI
 OJ
 OK
 OL
 OM
 ON
 OO
 OP
 OQ
 OR
 OS
 OT
 OU
 OV
 OW
 OX
 OY
 OZ
 PA
 PB
 PC
 PD
 PE
 PF
 PG
 PH
 PI
 PJ
 PK
 PL
 PM
 PN
 PO
 PP
 PQ
 PR
 PS
 PT
 PU
 PV
 PW
 PX
 PY
 PZ
 QA
 QB
 QC
 QD
 QE
 QF
 QG
 QH
 QI
 QJ
 QK
 QL
 QM
 QN
 QO
 QP
 QQ
 QR
 QS
 QT
 QU
 QV
 QW
 QX
 QY
 QZ
 RA
 RB
 RC
 RD
 RE
 RF
 RG
 RH
 RI
 RJ
 RK
 RL
 RM
 RN
 RO
 RP
 RQ
 RR
 RS
 RT
 RU
 RV
 RW
 RX
 RY
 RZ
 SA
 SB
 SC
 SD
 SE
 SF
 SG
 SH
 SI
 SJ
 SK
 SL
 SM
 SN
 SO
 SP
 SQ
 SR
 SS
 ST
 SU
 SV
 SW
 SX
 SY
 SZ
 TA
 TB
 TC
 TD
 TE
 TF
 TG
 TH
 TI
 TJ
 TK
 TL
 TM
 TN
 TO
 TP
 TQ
 TR
 TS
 TT
 TU
 TV
 TW
 TX
 TY
 TZ
 UA
 UB
 UC
 UD
 UE
 UF
 UG
 UH
 UI
 UJ
 UK
 UL
 UM
 UN
 UO
 UP
 UQ
 UR
 US
 UT
 UY
 UZ
 VA
 VB
 VC
 VD
 VE
 VF
 VG
 VH
 VI
 VJ
 VK
 VL
 VM
 VN
 VO
 VP
 VQ
 VR
 VS
 VT
 VU
 VV
 VW
 VX
 VY
 VZ
 WA
 WB
 WC
 WD
 WE
 WF
 WG
 WH
 WI
 WJ
 WK
 WL
 WM
 WN
 WO
 WP
 WQ
 WR
 WS
 WT
 WU
 WV
 WW
 WX
 WY
 WZ
 XA
 XB
 XC
 XD
 XE
 XF
 XG
 XH
 XI
 XJ
 XK
 XL
 XM
 XN
 XO
 XP
 XQ
 XR
 XS
 XT
 XU
 XV
 XW
 XX
 XY
 XZ
 YA
 YB
 YC
 YD
 YE
 YF
 YG
 YH
 YI
 YJ
 YK
 YL
 YM
 YN
 YO
 YP
 YQ
 YR
 YS
 YT
 YU
 YV
 YW
 YX
 YZ
 ZA
 ZB
 ZC
 ZD
 ZE
 ZF
 ZG
 ZH
 ZI
 ZJ
 ZK
 ZL
 ZM
 ZN
 ZO
 ZP
 ZQ
 ZR
 ZS
 ZT
 ZU
 ZV
 ZW
 ZX
 ZY
 ZZ

Wurzelheber
 Root elevators
 Elevadores para raices
 Elevateurs à racines
 Elevatori per radici



COLEMAN
 15,0 cm/6"



Fig.1
 PF 080/01



Fig.2L
 PF 080/02



Fig.3R
 PF 080/03

Wurzelheber
 Root elevators
 Elevadores para raíces
 Elevateurs à racines
 Elevatori per radici



COUPLAND
 15,0 cm/6"



Fig. 1
 PF 082/01



Fig. 2
 PF 082/02



Fig. 3
 PF 082/03

AA
 AB
 AC
 AD
 AE
 AF
 AG
 AH
 AI
 AJ
 AK
 AL
 AM
 AN
 AO
 AP
 AQ
 AR
 AS
 AT
 AU
 AV
 AW
 AX
 AY
 AZ
 BA
 BB
 BC
 BD
 BE
 BF
 BG
 BH
 BI
 BJ
 BK
 BL
 BM
 BN
 BO
 BP
 BQ
 BR
 BS
 BT
 BU
 BV
 BW
 BX
 BY
 BZ
 CA
 CB
 CC
 CD
 CE
 CF
 CG
 CH
 CI
 CJ
 CK
 CL
 CM
 CN
 CO
 CP
 CQ
 CR
 CS
 CT
 CU
 CV
 CW
 CX
 CY
 CZ
 DA
 DB
 DC
 DD
 DE
 DF
 DG
 DH
 DI
 DJ
 DK
 DL
 DM
 DN
 DO
 DP
 DQ
 DR
 DS
 DT
 DU
 DV
 DW
 DX
 DY
 DZ
 EA
 EB
 EC
 ED
 EE
 EF
 EG
 EH
 EI
 EJ
 EK
 EL
 EM
 EN
 EO
 EP
 EQ
 ER
 ES
 ET
 EU
 EV
 EW
 EX
 EY
 EZ
 FA
 FB
 FC
 FD
 FE
 FF
 FG
 FH
 FI
 FJ
 FK
 FL
 FM
 FN
 FO
 FP
 FQ
 FR
 FS
 FT
 FU
 FV
 FW
 FX
 FY
 FZ
 GA
 GB
 GC
 GD
 GE
 GF
 GG
 GH
 GI
 GJ
 GK
 GL
 GM
 GN
 GO
 GP
 GQ
 GR
 GS
 GT
 GU
 GV
 GW
 GX
 GY
 GZ
 HA
 HB
 HC
 HD
 HE
 HF
 HG
 HH
 HI
 HJ
 HK
 HL
 HM
 HN
 HO
 HP
 HQ
 HR
 HS
 HT
 HU
 HV
 HW
 HX
 HY
 HZ
 IA
 IB
 IC
 ID
 IE
 IF
 IG
 IH
 II
 IJ
 IK
 IL
 IM
 IN
 IO
 IP
 IQ
 IR
 IS
 IT
 IU
 IV
 IW
 IX
 IY
 IZ
 JA
 JB
 JC
 JD
 JE
 JF
 JG
 JH
 JI
 JJ
 JK
 JL
 JM
 JN
 JO
 JP
 JQ
 JR
 JS
 JT
 JU
 JV
 JW
 JX
 JY
 JZ
 KA
 KB
 KC
 KD
 KE
 KF
 KG
 KH
 KI
 KJ
 KK
 KL
 KM
 KN
 KO
 KP
 KQ
 KR
 KS
 KT
 KU
 KV
 KW
 KX
 KY
 KZ
 LA
 LB
 LC
 LD
 LE
 LF
 LG
 LH
 LI
 LJ
 LK
 LL
 LM
 LN
 LO
 LP
 LQ
 LR
 LS
 LT
 LU
 LV
 LW
 LX
 LY
 LZ
 MA
 MB
 MC
 MD
 ME
 MF
 MG
 MH
 MI
 MJ
 MK
 ML
 MM
 MN
 MO
 MP
 MQ
 MR
 MS
 MT
 MU
 MV
 MW
 MX
 MY
 MZ
 NA
 NB
 NC
 ND
 NE
 NF
 NG
 NH
 NI
 NJ
 NK
 NL
 NM
 NN
 NO
 NP
 NQ
 NR
 NS
 NT
 NU
 NV
 NW
 NX
 NY
 NZ
 OA
 OB
 OC
 OD
 OE
 OF
 OG
 OH
 OI
 OJ
 OK
 OL
 OM
 ON
 OO
 OP
 OQ
 OR
 OS
 OT
 OU
 OV
 OW
 OX
 OY
 OZ
 PA
 PB
 PC
 PD
 PE
 PF
 PG
 PH
 PI
 PJ
 PK
 PL
 PM
 PN
 PO
 PP
 PQ
 PR
 PS
 PT
 PU
 PV
 PW
 PX
 PY
 PZ
 QA
 QB
 QC
 QD
 QE
 QF
 QG
 QH
 QI
 QJ
 QK
 QL
 QM
 QN
 QO
 QP
 QQ
 QR
 QS
 QT
 QU
 QV
 QW
 QX
 QY
 QZ
 RA
 RB
 RC
 RD
 RE
 RF
 RG
 RH
 RI
 RJ
 RK
 RL
 RM
 RN
 RO
 RP
 RQ
 RR
 RS
 RT
 RU
 RV
 RW
 RX
 RY
 RZ
 SA
 SB
 SC
 SD
 SE
 SF
 SG
 SH
 SI
 SJ
 SK
 SL
 SM
 SN
 SO
 SP
 SQ
 SR
 SS
 ST
 SU
 SV
 SW
 SX
 SY
 SZ
 TA
 TB
 TC
 TD
 TE
 TF
 TG
 TH
 TI
 TJ
 TK
 TL
 TM
 TN
 TO
 TP
 TQ
 TR
 TS
 TT
 TU
 TV
 TW
 TX
 TY
 TZ
 UA
 UB
 UC
 UD
 UE
 UF
 UG
 UH
 UI
 UJ
 UK
 UL
 UM
 UN
 UO
 UP
 UQ
 UR
 US
 UT
 UY
 UZ
 VA
 VB
 VC
 VD
 VE
 VF
 VG
 VH
 VI
 VJ
 VK
 VL
 VM
 VN
 VO
 VP
 VQ
 VR
 VS
 VT
 VU
 VV
 VW
 VX
 VY
 VZ
 WA
 WB
 WC
 WD
 WE
 WF
 WG
 WH
 WI
 WJ
 WK
 WL
 WM
 WN
 WO
 WP
 WQ
 WR
 WS
 WT
 WU
 WV
 WW
 WX
 WY
 WZ
 XA
 XB
 XC
 XD
 XE
 XF
 XG
 XH
 XI
 XJ
 XK
 XL
 XM
 XN
 XO
 XP
 XQ
 XR
 XS
 XT
 XU
 XV
 XW
 XX
 XY
 XZ
 YA
 YB
 YC
 YD
 YE
 YF
 YG
 YH
 YI
 YJ
 YK
 YL
 YM
 YN
 YO
 YP
 YQ
 YR
 YS
 YT
 YU
 YV
 YW
 YX
 YZ
 ZA
 ZB
 ZC
 ZD
 ZE
 ZF
 ZG
 ZH
 ZI
 ZJ
 ZK
 ZL
 ZM
 ZN
 ZO
 ZP
 ZQ
 ZR
 ZS
 ZT
 ZU
 ZV
 ZW
 ZX
 ZY
 ZZ

Wurzelheber
 Root elevators
 Elevadores para raíces
 Elevateurs à racines
 Elevatori per radici



FRIEDMAN
 15,0 cm/6"



Fig.1
 PF 084/01



Fig.2L
 PF 084/02



Fig.3R
 PF 084/03

Wurzelheber
 Root elevators
 Elevadores para raíces
 Elevateurs à racines
 Elevatori per radici



LINDO LEVIAN
 15,0 cm/6"



Fig.1
 PF 085/01



Fig.3
 PF 085/03



MILLER-APEXO
 15,0 cm/6"



Fig.10
 PF 085/10



Fig.11
 PF 085/11

AA
 AB
 AC
 AD
 AE
 AF
 AG
 AH
 AI
 AJ
 AK
 AL
 AM
 AN
 AO
 AP
 AQ
 AR
 AS
 AT
 AU
 AV
 AW
 AX
 AY
 AZ
 BA
 BB
 BC
 BD
 BE
 BF
 BG
 BH
 BI
 BJ
 BK
 BL
 BM
 BN
 BO
 BP
 BQ
 BR
 BS
 BT
 BU
 BV
 BW
 BX
 BY
 BZ
 CA
 CB
 CC
 CD
 CE
 CF
 CG
 CH
 CI
 CJ
 CK
 CL
 CM
 CN
 CO
 CP
 CQ
 CR
 CS
 CT
 CU
 CV
 CW
 CX
 CY
 CZ
 DA
 DB
 DC
 DD
 DE
 DF
 DG
 DH
 DI
 DJ
 DK
 DL
 DM
 DN
 DO
 DP
 DQ
 DR
 DS
 DT
 DU
 DV
 DW
 DX
 DY
 DZ
 EA
 EB
 EC
 ED
 EE
 EF
 EG
 EH
 EI
 EJ
 EK
 EL
 EM
 EN
 EO
 EP
 EQ
 ER
 ES
 ET
 EU
 EV
 EW
 EX
 EY
 EZ
 FA
 FB
 FC
 FD
 FE
 FF
 FG
 FH
 FI
 FJ
 FK
 FL
 FM
 FN
 FO
 FP
 FQ
 FR
 FS
 FT
 FU
 FV
 FW
 FX
 FY
 FZ
 GA
 GB
 GC
 GD
 GE
 GF
 GG
 GH
 GI
 GJ
 GK
 GL
 GM
 GN
 GO
 GP
 GQ
 GR
 GS
 GT
 GU
 GV
 GW
 GX
 GY
 GZ
 HA
 HB
 HC
 HD
 HE
 HF
 HG
 HH
 HI
 HJ
 HK
 HL
 HM
 HN
 HO
 HP
 HQ
 HR
 HS
 HT
 HU
 HV
 HW
 HX
 HY
 HZ
 IA
 IB
 IC
 ID
 IE
 IF
 IG
 IH
 II
 IJ
 IK
 IL
 IM
 IN
 IO
 IP
 IQ
 IR
 IS
 IT
 IU
 IV
 IW
 IX
 IY
 IZ
 JA
 JB
 JC
 JD
 JE
 JF
 JG
 JH
 JI
 JJ
 JK
 JL
 JM
 JN
 JO
 JP
 JQ
 JR
 JS
 JT
 JU
 JV
 JW
 JX
 JY
 JZ
 KA
 KB
 KC
 KD
 KE
 KF
 KG
 KH
 KI
 KJ
 KK
 KL
 KM
 KN
 KO
 KP
 KQ
 KR
 KS
 KT
 KU
 KV
 KW
 KX
 KY
 KZ
 LA
 LB
 LC
 LD
 LE
 LF
 LG
 LH
 LI
 LJ
 LK
 LL
 LM
 LN
 LO
 LP
 LQ
 LR
 LS
 LT
 LU
 LV
 LW
 LX
 LY
 LZ
 MA
 MB
 MC
 MD
 ME
 MF
 MG
 MH
 MI
 MJ
 MK
 ML
 MM
 MN
 MO
 MP
 MQ
 MR
 MS
 MT
 MU
 MV
 MW
 MX
 MY
 MZ
 NA
 NB
 NC
 ND
 NE
 NF
 NG
 NH
 NI
 NJ
 NK
 NL
 NM
 NN
 NO
 NP
 NQ
 NR
 NS
 NT
 NU
 NV
 NW
 NX
 NY
 NZ
 OA
 OB
 OC
 OD
 OE
 OF
 OG
 OH
 OI
 OJ
 OK
 OL
 OM
 ON
 OO
 OP
 OQ
 OR
 OS
 OT
 OU
 OV
 OW
 OX
 OY
 OZ
 PA
 PB
 PC
 PD
 PE
 PF
 PG
 PH
 PI
 PJ
 PK
 PL
 PM
 PN
 PO
 PP
 PQ
 PR
 PS
 PT
 PU
 PV
 PW
 PX
 PY
 PZ
 QA
 QB
 QC
 QD
 QE
 QF
 QG
 QH
 QI
 QJ
 QK
 QL
 QM
 QN
 QO
 QP
 QQ
 QR
 QS
 QT
 QU
 QV
 QW
 QX
 QY
 QZ
 RA
 RB
 RC
 RD
 RE
 RF
 RG
 RH
 RI
 RJ
 RK
 RL
 RM
 RN
 RO
 RP
 RQ
 RR
 RS
 RT
 RU
 RV
 RW
 RX
 RY
 RZ
 SA
 SB
 SC
 SD
 SE
 SF
 SG
 SH
 SI
 SJ
 SK
 SL
 SM
 SN
 SO
 SP
 SQ
 SR
 SS
 ST
 SU
 SV
 SW
 SX
 SY
 SZ
 TA
 TB
 TC
 TD
 TE
 TF
 TG
 TH
 TI
 TJ
 TK
 TL
 TM
 TN
 TO
 TP
 TQ
 TR
 TS
 TT
 TU
 TV
 TW
 TX
 TY
 TZ
 UA
 UB
 UC
 UD
 UE
 UF
 UG
 UH
 UI
 UJ
 UK
 UL
 UM
 UN
 UO
 UP
 UQ
 UR
 US
 UT
 UY
 UZ
 VA
 VB
 VC
 VD
 VE
 VF
 VG
 VH
 VI
 VJ
 VK
 VL
 VM
 VN
 VO
 VP
 VQ
 VR
 VS
 VT
 VY
 VZ
 WA
 WB
 WC
 WD
 WE
 WF
 WG
 WH
 WI
 WJ
 WK
 WL
 WM
 WN
 WO
 WP
 WQ
 WR
 WS
 WT
 WY
 WZ
 XA
 XB
 XC
 XD
 XE
 XF
 XG
 XH
 XI
 XJ
 XK
 XL
 XM
 XN
 XO
 XP
 XQ
 XR
 XS
 XT
 XU
 XV
 XW
 XX
 XY
 XZ
 YA
 YB
 YC
 YD
 YE
 YF
 YG
 YH
 YI
 YJ
 YK
 YL
 YM
 YN
 YO
 YP
 YQ
 YR
 YS
 YT
 YZ
 ZA
 ZB
 ZC
 ZD
 ZE
 ZF
 ZG
 ZH
 ZI
 ZJ
 ZK
 ZL
 ZM
 ZN
 ZO
 ZP
 ZQ
 ZR
 ZS
 ZT
 ZY
 ZZ

Wurzelheber
 Root elevators
 Elevadores para raices
 Elevateurs à racines
 Elevatori per radici



HYLIN
 14,0 cm/5½"



Fig.1
 PF 086/01



Fig.2
 PF 086/02



Fig.3L
 PF 086/03



Fig.4R
 PF 086/04

WURZELHEBER ROOT ELEVATORS ELEVADORES PARA RAICES ELEVATEURS A RACINES ELEVATORI PER RADICI

Wurzelheber
 Root elevators
 Elevadores para raíces
 Elevateurs à racines
 Elevatori per radici

AA
 AB
 AC
 AD
 AE
 AF
 AG
 AH
 AI
 AJ
 AK
 AL
 AM
 AN
 AO
 AP
 AQ
 AR
 AS
 AT
 AU
 AV
 AW
 AX
 AY
 AZ
 BA
 BB
 BC
 BD
 BE
 BF
 BG
 BH
 BI
 BJ
 BK
 BL
 BM
 BN
 BO
 BP
 BQ
 BR
 BS
 BT
 BU
 BV
 BW
 BX
 BY
 BZ
 CA
 CB
 CC
 CD
 CE
 CF
 CG
 CH
 CI
 CJ
 CK
 CL
 CM
 CN
 CO
 CP
 CQ
 CR
 CS
 CT
 CU
 CV
 CW
 CX
 CY
 CZ
 DA
 DB
 DC
 DD
 DE
 DF
 DG
 DH
 DI
 DJ
 DK
 DL
 DM
 DN
 DO
 DP
 DQ
 DR
 DS
 DT
 DU
 DV
 DW
 DX
 DY
 DZ
 EA
 EB
 EC
 ED
 EE
 EF
 EG
 EH
 EI
 EJ
 EK
 EL
 EM
 EN
 EO
 EP
 EQ
 ER
 ES
 ET
 EU
 EV
 EW
 EX
 EY
 EZ
 FA
 FB
 FC
 FD
 FE
 FF
 FG
 FH
 FI
 FJ
 FK
 FL
 FM
 FN
 FO
 FP
 FQ
 FR
 FS
 FT
 FU
 FV
 FW
 FX
 FY
 FZ
 GA
 GB
 GC
 GD
 GE
 GF
 GG
 GH
 GI
 GJ
 GK
 GL
 GM
 GN
 GO
 GP
 GQ
 GR
 GS
 GT
 GU
 GV
 GW
 GX
 GY
 GZ
 HA
 HB
 HC
 HD
 HE
 HF
 HG
 HH
 HI
 HJ
 HK
 HL
 HM
 HN
 HO
 HP
 HQ
 HR
 HS
 HT
 HU
 HV
 HW
 HX
 HY
 HZ
 IA
 IB
 IC
 ID
 IE
 IF
 IG
 IH
 II
 IJ
 IK
 IL
 IM
 IN
 IO
 IP
 IQ
 IR
 IS
 IT
 IU
 IV
 IW
 IX
 IY
 IZ
 JA
 JB
 JC
 JD
 JE
 JF
 JG
 JH
 JI
 JJ
 JK
 JL
 JM
 JN
 JO
 JP
 JQ
 JR
 JS
 JT
 JU
 JV
 JW
 JX
 JY
 JZ
 KA
 KB
 KC
 KD
 KE
 KF
 KG
 KH
 KI
 KJ
 KK
 KL
 KM
 KN
 KO
 KP
 KQ
 KR
 KS
 KT
 KU
 KV
 KW
 KX
 KY
 KZ
 LA
 LB
 LC
 LD
 LE
 LF
 LG
 LH
 LI
 LJ
 LK
 LL
 LM
 LN
 LO
 LP
 LQ
 LR
 LS
 LT
 LU
 LV
 LW
 LX
 LY
 LZ
 MA
 MB
 MC
 MD
 ME
 MF
 MG
 MH
 MI
 MJ
 MK
 ML
 MM
 MN
 MO
 MP
 MQ
 MR
 MS
 MT
 MU
 MV
 MW
 MX
 MY
 MZ
 NA
 NB
 NC
 ND
 NE
 NF
 NG
 NH
 NI
 NJ
 NK
 NL
 NM
 NN
 NO
 NP
 NQ
 NR
 NS
 NT
 NU
 NV
 NW
 NX
 NY
 NZ
 OA
 OB
 OC
 OD
 OE
 OF
 OG
 OH
 OI
 OJ
 OK
 OL
 OM
 ON
 OO
 OP
 OQ
 OR
 OS
 OT
 OU
 OV
 OW
 OX
 OY
 OZ
 PA
 PB
 PC
 PD
 PE
 PF
 PG
 PH
 PI
 PJ
 PK
 PL
 PM
 PN
 PO
 PP
 PQ
 PR
 PS
 PT
 PU
 PV
 PW
 PX
 PY
 PZ
 QA
 QB
 QC
 QD
 QE
 QF
 QG
 QH
 QI
 QJ
 QK
 QL
 QM
 QN
 QO
 QP
 QQ
 QR
 QS
 QT
 QU
 QV
 QW
 QX
 QY
 QZ
 RA
 RB
 RC
 RD
 RE
 RF
 RG
 RH
 RI
 RJ
 RK
 RL
 RM
 RN
 RO
 RP
 RQ
 RR
 RS
 RT
 RU
 RV
 RW
 RX
 RY
 RZ
 SA
 SB
 SC
 SD
 SE
 SF
 SG
 SH
 SI
 SJ
 SK
 SL
 SM
 SN
 SO
 SP
 SQ
 SR
 SS
 ST
 SU
 SV
 SW
 SX
 SY
 SZ
 TA
 TB
 TC
 TD
 TE
 TF
 TG
 TH
 TI
 TJ
 TK
 TL
 TM
 TN
 TO
 TP
 TQ
 TR
 TS
 TT
 TU
 TV
 TW
 TX
 TY
 TZ
 UA
 UB
 UC
 UD
 UE
 UF
 UG
 UH
 UI
 UJ
 UK
 UL
 UM
 UN
 UO
 UP
 UQ
 UR
 US
 UT
 UY
 UZ
 VA
 VB
 VC
 VD
 VE
 VF
 VG
 VH
 VI
 VJ
 VK
 VL
 VM
 VN
 VO
 VP
 VQ
 VR
 VS
 VT
 VU
 VV
 VW
 VX
 VY
 VZ
 WA
 WB
 WC
 WD
 WE
 WF
 WG
 WH
 WI
 WJ
 WK
 WL
 WM
 WN
 WO
 WP
 WQ
 WR
 WS
 WT
 WU
 WV
 WW
 WX
 WY
 WZ
 XA
 XB
 XC
 XD
 XE
 XF
 XG
 XH
 XI
 XJ
 XK
 XL
 XM
 XN
 XO
 XP
 XQ
 XR
 XS
 XT
 XU
 XV
 XW
 XX
 XY
 XZ
 YA
 YB
 YC
 YD
 YE
 YF
 YG
 YH
 YI
 YJ
 YK
 YL
 YM
 YN
 YO
 YP
 YQ
 YR
 YS
 YT
 YU
 YV
 YW
 YX
 YZ
 ZA
 ZB
 ZC
 ZD
 ZE
 ZF
 ZG
 ZH
 ZI
 ZJ
 ZK
 ZL
 ZM
 ZN
 ZO
 ZP
 ZQ
 ZR
 ZS
 ZT
 ZU
 ZV
 ZW
 ZX
 ZY
 ZZ



Fig.0
 PF 090/00



Fig.1
 PF 090/01



Fig.2
 PF 090/02



Fig.0A
 PF 091/00



Fig.1A
 PF 091/01



Fig.2A
 PF 091/02



BEIN
 13,0 cm/5"

Wurzelheber
 Root elevators
 Elevadores para raíces
 Elevateurs à racines
 Elevatori per radici



16,0 cm/6¹/₄"



Fig.1
 PF 092/01



Fig.2
 PF 092/02



Fig.3
 PF 092/03



Fig.4
 PF 092/04



Fig.7
 PF 092/07



Fig.8
 PF 092/08



Fig.11
 PF 092/11



Fig.12
 PF 092/12



Fig.13
 PF 092/13

WURZELHEBER ROOT ELEVATORS ELEVADORES PARA RAICES ELEVATEURS A RACINES ELEVATORI PER RADICI

Wurzelheber
 Root elevators
 Elevadores para raíces
 Elevateurs à racines
 Elevatori per radici



16,0 cm/6 1/4"



Fig.16
 PF 092/16



Fig.17
 PF 092/17



Fig.18
 PF 092/18



Fig.19
 PF 092/19



Fig.20
 PF 092/20



Fig.21
 PF 092/21

AA
 AB
 AC
 AD
 AE
 AF
 AG
 AH
 AI
 AJ
 AK
 AL
 AO
 AP
 AQ
 AR
 AS
 AT
 AU
 AV
 AW
 AX
 AY
 AZ
 BA
 BB
 BC
 BD
 BE
 BF
 BG
 BH
 BI
 BJ
 BK
 BL
 BM
 BN
 BO
 BP
 BQ
 BR
 BS
 BT
 BU
 BV
 BW
 BX
 BY
 BZ
 CA
 CB
 CC
 CD
 CE
 CF
 CG
 CH
 CI
 CJ
 CK
 CL
 CM
 CN
 CO
 CP
 CQ
 CR
 CS
 CT
 CU
 CV
 CW
 CX
 CY
 CZ
 DA
 DB
 DC
 DD
 DE
 DF
 DG
 DH
 DI
 DJ
 DK
 DL
 DM
 DN
 DO
 DP
 DQ
 DR
 DS
 DT
 DU
 DV
 DW
 DX
 DY
 DZ
 EA
 EB
 EC
 ED
 EE
 EF
 EG
 EH
 EI
 EJ
 EK
 EL
 EM
 EN
 EO
 EP
 EQ
 ER
 ES
 ET
 EU
 EV
 EW
 EX
 EY
 EZ
 FA
 FB
 FC
 FD
 FE
 FF
 FG
 FH
 FI
 FJ
 FK
 FL
 FM
 FN
 FO
 FP
 FQ
 FR
 FS
 FT
 FU
 FV
 FW
 FX
 FY
 FZ
 GA
 GB
 GC
 GD
 GE
 GF
 GG
 GH
 GI
 GJ
 GK
 GL
 GM
 GN
 GO
 GP
 GQ
 GR
 GS
 GT
 GU
 GV
 GW
 GX
 GY
 GZ
 HA
 HB
 HC
 HD
 HE
 HF
 HG
 HH
 HI
 HJ
 HK
 HL
 HM
 HN
 HO
 HP
 HQ
 HR
 HS
 HT
 HU
 HV
 HW
 HX
 HY
 HZ
 IA
 IB
 IC
 ID
 IE
 IF
 IG
 IH
 II
 IJ
 IK
 IL
 IM
 IN
 IO
 IP
 IQ
 IR
 IS
 IT
 IU
 IV
 IW
 IX
 IY
 IZ
 JA
 JB
 JC
 JD
 JE
 JF
 JG
 JH
 JI
 JJ
 JK
 JL
 JM
 JN
 JO
 JP
 JQ
 JR
 JS
 JT
 JU
 JV
 JW
 JX
 JY
 JZ
 KA
 KB
 KC
 KD
 KE
 KF
 KG
 KH
 KI
 KJ
 KK
 KL
 KM
 KN
 KO
 KP
 KQ
 KR
 KS
 KT
 KU
 KV
 KW
 KX
 KY
 KZ
 LA
 LB
 LC
 LD
 LE
 LF
 LG
 LH
 LI
 LJ
 LK
 LL
 LM
 LN
 LO
 LP
 LQ
 LR
 LS
 LT
 LU
 LV
 LW
 LX
 LY
 LZ
 MA
 MB
 MC
 MD
 ME
 MF
 MG
 MH
 MI
 MJ
 MK
 ML
 MM
 MN
 MO
 MP
 MQ
 MR
 MS
 MT
 MU
 MV
 MW
 MX
 MY
 MZ
 NA
 NB
 NC
 ND
 NE
 NF
 NG
 NH
 NI
 NJ
 NK
 NL
 NM
 NN
 NO
 NP
 NQ
 NR
 NS
 NT
 NU
 NV
 NW
 NX
 NY
 NZ
 OA
 OB
 OC
 OD
 OE
 OF
 OG
 OH
 OI
 OJ
 OK
 OL
 OM
 ON
 OO
 OP
 OQ
 OR
 OS
 OT
 OU
 OV
 OW
 OX
 OY
 OZ
 PA
 PB
 PC
 PD
 PE
 PF
 PG
 PH
 PI
 PJ
 PK
 PL
 PM
 PN
 PO
 PP
 PQ
 PR
 PS
 PT
 PU
 PV
 PW
 PX
 PY
 PZ
 QA
 QB
 QC
 QD
 QE
 QF
 QG
 QH
 QI
 QJ
 QK
 QL
 QM
 QN
 QO
 QP
 QQ
 QR
 QS
 QT
 QU
 QV
 QW
 QX
 QY
 QZ
 RA
 RB
 RC
 RD
 RE
 RF
 RG
 RH
 RI
 RJ
 RK
 RL
 RM
 RN
 RO
 RP
 RQ
 RR
 RS
 RT
 RU
 RV
 RW
 RX
 RY
 RZ
 SA
 SB
 SC
 SD
 SE
 SF
 SG
 SH
 SI
 SJ
 SK
 SL
 SM
 SN
 SO
 SP
 SQ
 SR
 SS
 ST
 SU
 SV
 SW
 SX
 SY
 SZ
 TA
 TB
 TC
 TD
 TE
 TF
 TG
 TH
 TI
 TJ
 TK
 TL
 TM
 TN
 TO
 TP
 TQ
 TR
 TS
 TT
 TU
 TV
 TW
 TX
 TY
 TZ
 UA
 UB
 UC
 UD
 UE
 UF
 UG
 UH
 UI
 UJ
 UK
 UL
 UM
 UN
 UO
 UP
 UQ
 UR
 US
 UT
 UY
 UZ
 VA
 VB
 VC
 VD
 VE
 VF
 VG
 VH
 VI
 VJ
 VK
 VL
 VM
 VN
 VO
 VP
 VQ
 VR
 VS
 VT
 VY
 VZ
 WA
 WB
 WC
 WD
 WE
 WF
 WG
 WH
 WI
 WJ
 WK
 WL
 WM
 WN
 WO
 WP
 WQ
 WR
 WS
 WT
 WY
 WZ
 XA
 XB
 XC
 XD
 XE
 XF
 XG
 XH
 XI
 XJ
 XK
 XL
 XM
 XN
 XO
 XP
 XQ
 XR
 XS
 XT
 XU
 XV
 XW
 XX
 XY
 XZ
 YA
 YB
 YC
 YD
 YE
 YF
 YG
 YH
 YI
 YJ
 YK
 YL
 YM
 YN
 YO
 YP
 YQ
 YR
 YS
 YT
 YZ
 ZA
 ZB
 ZC
 ZD
 ZE
 ZF
 ZG
 ZH
 ZI
 ZJ
 ZK
 ZL
 ZM
 ZN
 ZO
 ZP
 ZQ
 ZR
 ZS
 ZT
 ZY
 ZZ

Wurzelheber
 Root elevators
 Elevadores para raices
 Elevateurs à racines
 Elevatori per radici



Fig.1
 PF 096/01



Fig.2
 PF 096/02

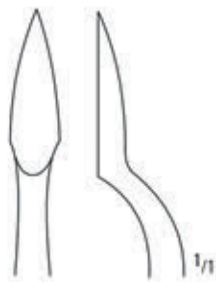
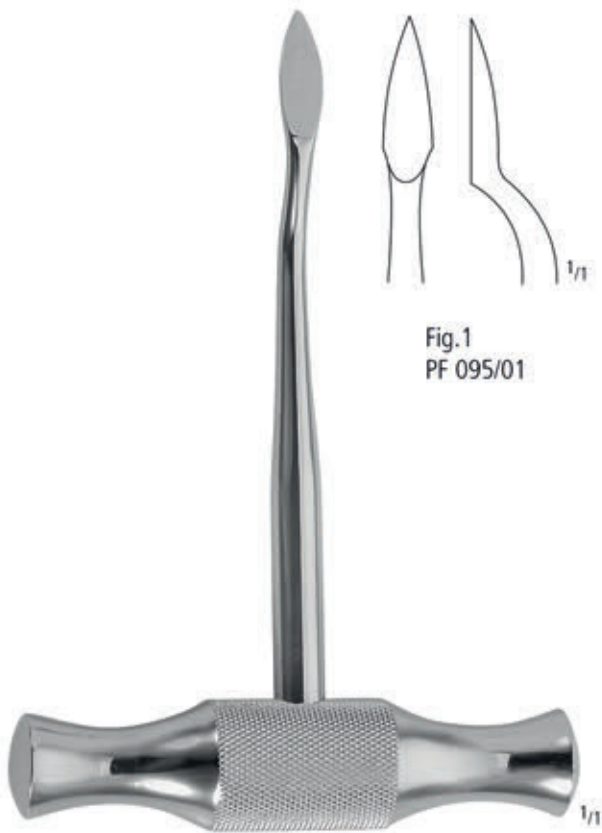

Fig.1
 PF 095/01



LECLUSE
 11,0 cm/4¹/₃"



POTT
 15,0 cm/6"

Wurzelheber
 Root elevators
 Elevadores para raíces
 Elevateurs à racines
 Elevatori per radici



WARWICK-JAMES
 16,0 cm/6¹/₄"



Fig.1
 PF 100/01



Fig.2L
 PF 100/02



Fig.3R
 PF 100/03

AA
 AB
 AC
 AD
 AE
 AF
 AG
 AH
 AI
 AJ
 AK
 AL
 AM
 AN
 AO
 AP
 AQ
 AR
 AS
 AT
 AU
 AV
 AW
 AX
 AY
 AZ
 BA
 BB
 BC
 BD
 BE
 BF
 BG
 BH
 BI
 BJ
 BK
 BL
 BM
 BN
 BO
 BP
 BQ
 BR
 BS
 BT
 BU
 BV
 BW
 BX
 BY
 BZ
 CA
 CB
 CC
 CD
 CE
 CF
 CG
 CH
 CI
 CJ
 CK
 CL
 CM
 CN
 CO
 CP
 CQ
 CR
 CS
 CT
 CU
 CV
 CW
 CX
 CY
 CZ
 DA
 DB
 DC
 DD
 DE
 DF
 DG
 DH
 DI
 DJ
 DK
 DL
 DM
 DN
 DO
 DP
 DQ
 DR
 DS
 DT
 DU
 DV
 DW
 DX
 DY
 DZ
 EA
 EB
 EC
 ED
 EE
 EF
 EG
 EH
 EI
 EJ
 EK
 EL
 EM
 EN
 EO
 EP
 EQ
 ER
 ES
 ET
 EU
 EV
 EW
 EX
 EY
 EZ
 FA
 FB
 FC
 FD
 FE
 FF
 FG
 FH
 FI
 FJ
 FK
 FL
 FM
 FN
 FO
 FP
 FQ
 FR
 FS
 FT
 FU
 FV
 FW
 FX
 FY
 FZ
 GA
 GB
 GC
 GD
 GE
 GF
 GG
 GH
 GI
 GJ
 GK
 GL
 GM
 GN
 GO
 GP
 GQ
 GR
 GS
 GT
 GU
 GV
 GW
 GX
 GY
 GZ
 HA
 HB
 HC
 HD
 HE
 HF
 HG
 HH
 HI
 HJ
 HK
 HL
 HM
 HN
 HO
 HP
 HQ
 HR
 HS
 HT
 HU
 HV
 HW
 HX
 HY
 HZ
 IA
 IB
 IC
 ID
 IE
 IF
 IG
 IH
 II
 IJ
 IK
 IL
 IM
 IN
 IO
 IP
 IQ
 IR
 IS
 IT
 IU
 IV
 IW
 IX
 IY
 IZ
 JA
 JB
 JC
 JD
 JE
 JF
 JG
 JH
 JI
 JJ
 JK
 JL
 JM
 JN
 JO
 JP
 JQ
 JR
 JS
 JT
 JU
 JV
 JW
 JX
 JY
 JZ
 KA
 KB
 KC
 KD
 KE
 KF
 KG
 KH
 KI
 KJ
 KK
 KL
 KM
 KN
 KO
 KP
 KQ
 KR
 KS
 KT
 KU
 KV
 KW
 KX
 KY
 KZ
 LA
 LB
 LC
 LD
 LE
 LF
 LG
 LH
 LI
 LJ
 LK
 LL
 LM
 LN
 LO
 LP
 LQ
 LR
 LS
 LT
 LU
 LV
 LW
 LX
 LY
 LZ
 MA
 MB
 MC
 MD
 ME
 MF
 MG
 MH
 MI
 MJ
 MK
 ML
 MM
 MN
 MO
 MP
 MQ
 MR
 MS
 MT
 MU
 MV
 MW
 MX
 MY
 MZ
 NA
 NB
 NC
 ND
 NE
 NF
 NG
 NH
 NI
 NJ
 NK
 NL
 NM
 NN
 NO
 NP
 NQ
 NR
 NS
 NT
 NU
 NV
 NW
 NX
 NY
 NZ
 OA
 OB
 OC
 OD
 OE
 OF
 OG
 OH
 OI
 OJ
 OK
 OL
 OM
 ON
 OO
 OP
 OQ
 OR
 OS
 OT
 OU
 OV
 OW
 OX
 OY
 OZ
 PA
 PB
 PC
 PD
 PE
 PF
 PG
 PH
 PI
 PJ
 PK
 PL
 PM
 PN
 PO
 PP
 PQ
 PR
 PS
 PT
 PU
 PV
 PW
 PX
 PY
 PZ
 QA
 QB
 QC
 QD
 QE
 QF
 QG
 QH
 QI
 QJ
 QK
 QL
 QM
 QN
 QO
 QP
 QQ
 QR
 QS
 QT
 QU
 QV
 QW
 QX
 QY
 QZ
 RA
 RB
 RC
 RD
 RE
 RF
 RG
 RH
 RI
 RJ
 RK
 RL
 RM
 RN
 RO
 RP
 RQ
 RR
 RS
 RT
 RU
 RV
 RW
 RX
 RY
 RZ
 SA
 SB
 SC
 SD
 SE
 SF
 SG
 SH
 SI
 SJ
 SK
 SL
 SM
 SN
 SO
 SP
 SQ
 SR
 SS
 ST
 SU
 SV
 SW
 SX
 SY
 SZ
 TA
 TB
 TC
 TD
 TE
 TF
 TG
 TH
 TI
 TJ
 TK
 TL
 TM
 TN
 TO
 TP
 TQ
 TR
 TS
 TT
 TU
 TV
 TW
 TX
 TY
 TZ
 UA
 UB
 UC
 UD
 UE
 UF
 UG
 UH
 UI
 UJ
 UK
 UL
 UM
 UN
 UO
 UP
 UQ
 UR
 US
 UT
 UY
 UZ
 VA
 VB
 VC
 VD
 VE
 VF
 VG
 VH
 VI
 VJ
 VK
 VL
 VM
 VN
 VO
 VP
 VQ
 VR
 VS
 VT
 VU
 VV
 VW
 VX
 VY
 VZ
 WA
 WB
 WC
 WD
 WE
 WF
 WG
 WH
 WI
 WJ
 WK
 WL
 WM
 WN
 WO
 WP
 WQ
 WR
 WS
 WT
 WU
 WV
 WW
 WX
 WY
 WZ
 XA
 XB
 XC
 XD
 XE
 XF
 XG
 XH
 XI
 XJ
 XK
 XL
 XM
 XN
 XO
 XP
 XQ
 XR
 XS
 XT
 XU
 XV
 XW
 XX
 XY
 XZ
 YA
 YB
 YC
 YD
 YE
 YF
 YG
 YH
 YI
 YJ
 YK
 YL
 YM
 YN
 YO
 YP
 YQ
 YR
 YS
 YT
 YU
 YV
 YW
 YX
 YZ
 ZA
 ZB
 ZC
 ZD
 ZE
 ZF
 ZG
 ZH
 ZI
 ZJ
 ZK
 ZL
 ZM
 ZN
 ZO
 ZP
 ZQ
 ZR
 ZS
 ZT
 ZU
 ZV
 ZW
 ZX
 ZY
 ZZ

Wurzelheber
 Root elevators
 Elevadores para raices
 Elevateurs à racines
 Elevatori per radici



Fig.320L
 PF 210/01



Fig.321R
 PF 210/02



Fig.322L
 PF 211/01



Fig.323R
 PF 211/02



W.F. BARRY
 11,0 cm/4¹/₃"

WURZELHEBER ROOT ELEVATORS ELEVADORES PARA RAICES ELEVATEURS A RACINES ELEVATORI PER RADICI

Wurzelheber
 Root elevators
 Elevadores para raíces
 Elevateurs à racines
 Elevatori per radici



WINTER
 11,0 cm/4 1/3"



Fig.11L
 PF 220/01



Fig.11R
 PF 220/02



Fig.12L
 PF 221/01



Fig.12R
 PF 221/02



Fig.13L
 PF 222/01



Fig.13R
 PF 222/02



Fig.14L
 PF 224/01



Fig.14R
 PF 224/02

AA
 AB
 AC
 AD
 AE
 AF
 AK
 AL
 AO
 AR
 KA
 KL
 KU
 PA
 PB
PF
 PI
 PK
 PL
 PM
 PP
 PS
 PT
 PU
 PV
 KYE

Wurzelheber
 Root elevators
 Elevadores para raices
 Elevateurs à racines
 Elevatori per radici



Fig.1
 PF 310/01



Fig.2
 PF 310/02



Fig.3
 PF 310/03

CHOMPRET
 16,0 cm/6 1/4"



Fig.1
 PF 310/11



Fig.3
 PF 310/13

CHOMPRET
 16,0 cm/6 1/4"
 massiv
 solid
 masivo
 massif
 massiccio

WURZELHEBER ROOT ELEVATORS ELEVADORES PARA RAICES ELEVATEURS A RACINES ELEVATORI PER RADICI

Wurzelheber
 Root elevators
 Elevadores para raíces
 Elevateurs à racines
 Elevatori per radici



HEIDBRINK
 14,0 cm/5 1/2"



Fig.1
 PF 311/01



Fig.2
 PF 311/02



Fig.3
 PF 311/03

AA
 AB
 AC
 AD
 AE
 AF
 AG
 AH
 AI
 AJ
 AK
 AL
 AM
 AN
 AO
 AP
 AQ
 AR
 AS
 AT
 AU
 AV
 AW
 AX
 AY
 AZ
 BA
 BB
 BC
 BD
 BE
 BF
 BG
 BH
 BI
 BJ
 BK
 BL
 BM
 BN
 BO
 BP
 BQ
 BR
 BS
 BT
 BU
 BV
 BW
 BX
 BY
 BZ
 CA
 CB
 CC
 CD
 CE
 CF
 CG
 CH
 CI
 CJ
 CK
 CL
 CM
 CN
 CO
 CP
 CQ
 CR
 CS
 CT
 CU
 CV
 CW
 CX
 CY
 CZ
 DA
 DB
 DC
 DD
 DE
 DF
 DG
 DH
 DI
 DJ
 DK
 DL
 DM
 DN
 DO
 DP
 DQ
 DR
 DS
 DT
 DU
 DV
 DW
 DX
 DY
 DZ
 EA
 EB
 EC
 ED
 EE
 EF
 EG
 EH
 EI
 EJ
 EK
 EL
 EM
 EN
 EO
 EP
 EQ
 ER
 ES
 ET
 EU
 EV
 EW
 EX
 EY
 EZ
 FA
 FB
 FC
 FD
 FE
 FF
 FG
 FH
 FI
 FJ
 FK
 FL
 FM
 FN
 FO
 FP
 FQ
 FR
 FS
 FT
 FU
 FV
 FW
 FX
 FY
 FZ
 GA
 GB
 GC
 GD
 GE
 GF
 GG
 GH
 GI
 GJ
 GK
 GL
 GM
 GN
 GO
 GP
 GQ
 GR
 GS
 GT
 GU
 GV
 GW
 GX
 GY
 GZ
 HA
 HB
 HC
 HD
 HE
 HF
 HG
 HH
 HI
 HJ
 HK
 HL
 HM
 HN
 HO
 HP
 HQ
 HR
 HS
 HT
 HU
 HV
 HW
 HX
 HY
 HZ
 IA
 IB
 IC
 ID
 IE
 IF
 IG
 IH
 II
 IJ
 IK
 IL
 IM
 IN
 IO
 IP
 IQ
 IR
 IS
 IT
 IU
 IV
 IW
 IX
 IY
 IZ
 JA
 JB
 JC
 JD
 JE
 JF
 JG
 JH
 JI
 JJ
 JK
 JL
 JM
 JN
 JO
 JP
 JQ
 JR
 JS
 JT
 JU
 JV
 JW
 JX
 JY
 JZ
 KA
 KB
 KC
 KD
 KE
 KF
 KG
 KH
 KI
 KJ
 KK
 KL
 KM
 KN
 KO
 KP
 KQ
 KR
 KS
 KT
 KU
 KV
 KW
 KX
 KY
 KZ
 LA
 LB
 LC
 LD
 LE
 LF
 LG
 LH
 LI
 LJ
 LK
 LL
 LM
 LN
 LO
 LP
 LQ
 LR
 LS
 LT
 LU
 LV
 LW
 LX
 LY
 LZ
 MA
 MB
 MC
 MD
 ME
 MF
 MG
 MH
 MI
 MJ
 MK
 ML
 MM
 MN
 MO
 MP
 MQ
 MR
 MS
 MT
 MU
 MV
 MW
 MX
 MY
 MZ
 NA
 NB
 NC
 ND
 NE
 NF
 NG
 NH
 NI
 NJ
 NK
 NL
 NM
 NN
 NO
 NP
 NQ
 NR
 NS
 NT
 NU
 NV
 NW
 NX
 NY
 NZ
 OA
 OB
 OC
 OD
 OE
 OF
 OG
 OH
 OI
 OJ
 OK
 OL
 OM
 ON
 OO
 OP
 OQ
 OR
 OS
 OT
 OU
 OV
 OW
 OX
 OY
 OZ
 PA
 PB
 PC
 PD
 PE
 PF
 PG
 PH
 PI
 PJ
 PK
 PL
 PM
 PN
 PO
 PP
 PQ
 PR
 PS
 PT
 PU
 PV
 PW
 PX
 PY
 PZ
 QA
 QB
 QC
 QD
 QE
 QF
 QG
 QH
 QI
 QJ
 QK
 QL
 QM
 QN
 QO
 QP
 QQ
 QR
 QS
 QT
 QU
 QV
 QW
 QX
 QY
 QZ
 RA
 RB
 RC
 RD
 RE
 RF
 RG
 RH
 RI
 RJ
 RK
 RL
 RM
 RN
 RO
 RP
 RQ
 RR
 RS
 RT
 RU
 RV
 RW
 RX
 RY
 RZ
 SA
 SB
 SC
 SD
 SE
 SF
 SG
 SH
 SI
 SJ
 SK
 SL
 SM
 SN
 SO
 SP
 SQ
 SR
 SS
 ST
 SU
 SV
 SW
 SX
 SY
 SZ
 TA
 TB
 TC
 TD
 TE
 TF
 TG
 TH
 TI
 TJ
 TK
 TL
 TM
 TN
 TO
 TP
 TQ
 TR
 TS
 TT
 TU
 TV
 TW
 TX
 TY
 TZ
 UA
 UB
 UC
 UD
 UE
 UF
 UG
 UH
 UI
 UJ
 UK
 UL
 UM
 UN
 UO
 UP
 UQ
 UR
 US
 UT
 UY
 UZ
 VA
 VB
 VC
 VD
 VE
 VF
 VG
 VH
 VI
 VJ
 VK
 VL
 VM
 VN
 VO
 VP
 VQ
 VR
 VS
 VT
 VU
 VV
 VW
 VX
 VY
 VZ
 WA
 WB
 WC
 WD
 WE
 WF
 WG
 WH
 WI
 WJ
 WK
 WL
 WM
 WN
 WO
 WP
 WQ
 WR
 WS
 WT
 WU
 WV
 WW
 WX
 WY
 WZ
 XA
 XB
 XC
 XD
 XE
 XF
 XG
 XH
 XI
 XJ
 XK
 XL
 XM
 XN
 XO
 XP
 XQ
 XR
 XS
 XT
 XU
 XV
 XW
 XX
 XY
 XZ
 YA
 YB
 YC
 YD
 YE
 YF
 YG
 YH
 YI
 YJ
 YK
 YL
 YM
 YN
 YO
 YP
 YQ
 YR
 YS
 YT
 YU
 YV
 YW
 YX
 YZ
 ZA
 ZB
 ZC
 ZD
 ZE
 ZF
 ZG
 ZH
 ZI
 ZJ
 ZK
 ZL
 ZM
 ZN
 ZO
 ZP
 ZQ
 ZR
 ZS
 ZT
 ZU
 ZV
 ZW
 ZX
 ZY
 ZZ

Wurzelheber
 Root elevators
 Elevadores para raíces
 Elevateurs à racines
 Elevatori per radici



16,0 cm/6¹/₄"



PF 311/13
 1,3 mm



PF 311/18
 1,8 mm



PF 311/23
 2,3 mm



PF 311/30
 1,3 mm



PF 311/31
 1,3 mm

WURZELHEBER ROOT ELEVATORS ELEVADORES PARA RAICES ELEVATEURS A RACINES ELEVATORI PER RADICI

Wurzelheber
 Root elevators
 Elevadores para raíces
 Elevateurs à racines
 Elevatori per radici



HEIDBRINK
 20,0 cm/8"

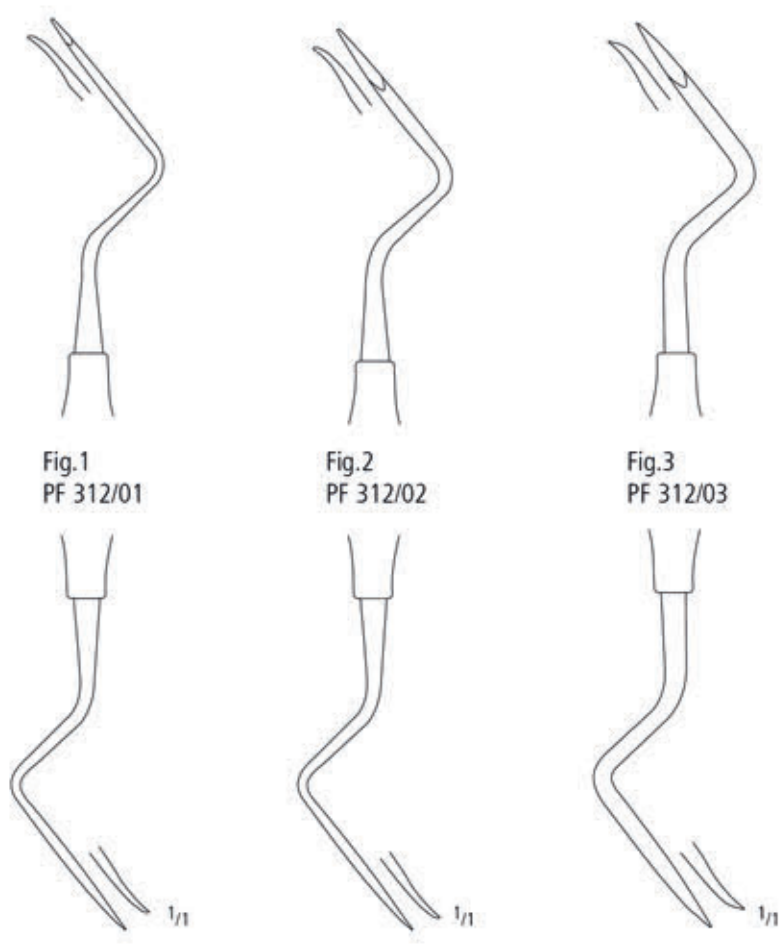

Fig.1
 PF 312/01

Fig.2
 PF 312/02

Fig.3
 PF 312/03

AA
 AB
 AC
 AD
 AE
 AF
 AK
 AL
 AO
 AR
 KA
 KL
 KU
 PA
 PB
PF
 PI
 PK
 PL
 PM
 PP
 PS
 PT
 PU
 PV
 KYE

Wurzelheber
 Root elevators
 Elevadores para raíces
 Elevateurs à racines
 Elevatori per radici



WEST
 16,0 cm/6 1/4"



Fig.1
 PF 313/01



Fig.2
 PF 313/02



Fig.3
 PF 313/03

ZAHNREINIGER
DENTAL SCALERS
LIMPIADORES DE SARRO
INSTRUMENTS A DETARTRE
LEVATARTARI DENTALI

PI

nopa[®] instruments



Zahnreiner
Dental scalers
Limpiadores de sarro
Instruments à détartrer
Levatartari dentali



15,5 cm/6"

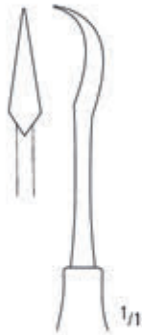

Fig.1
PI 010/01



Fig.2
PI 010/02



Fig.33A
PI 010/03



Fig.11
PI 010/11



Fig.33
PI 010/33



Fig.34
PI 010/34



Fig.35
PI 010/35



Fig.36
PI 010/36



Fig.17
PI 011/01



Fig.18
PI 011/02

Zahnreiniger
Dental scalers
Limpiadores de sarro
Instruments à détartrer
Levatartari dentali



17,5 cm/7"



McCALL
Fig.17/18
PI 011/17

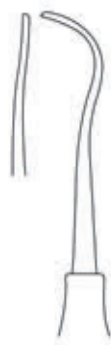

YOUNGER-GOOD
Fig.33/34
PI 031/02



CUMINE
Fig.33
PI 031/33

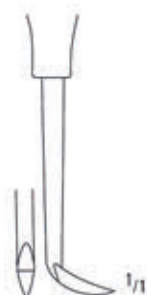

MITCHELL
Fig.34
PI 031/34



TOWNER
Fig.15/33
PI 043/30



Fig.15/30
PI 043/33



TOWNER
Fig.5/33
PI 044/33

AA AB AC AD AE AF AG AH AI AJ AK AL AM AN AO AP AQ AR AS AT AU AV AW AX AY AZ
BA BB BC BD BE BF BG BH BI BJ BK BL BM BN BO BP BQ BR BS BT BU BV BW BX BY BZ
CA CB CC CD CE CF CG CH CI CJ CK CL CM CN CO CP CQ CR CS CT CU CV CW CX CY CZ
DA DB DC DD DE DF DG DH DI DJ DK DL DM DN DO DP DQ DR DS DT DU DV DW DX DY DZ
EA EB EC ED EE EF EG EH EI EJ EK EL EM EN EO EP EQ ER ES ET EU EV EW EX EY EZ
FA FB FC FD FE FF FG FH FI FJ FK FL FM FN FO FP FQ FR FS FT FU FV FW FX FY FZ
GA GB GC GD GE GF GG GH GI GJ GK GL GM GN GO GP GQ GR GS GT GU GV GW GX GY GZ
HA HB HC HD HE HF HG HH HI HJ HK HL HM HN HO HP HQ HR HS HT HU HV HW HX HY HZ
IA IB IC ID IE IF IG IH II IJ IK IL IM IN IO IP IQ IR IS IT IU IV IW IX IY IZ
JA JB JC JD JE JF JG JH JI JJ JK JL JM JN JO JP JQ JR JS JT JU JV JW JX JY JZ
KA KB KC KD KE KF KG KH KI KJ KL KM KN KO KP KQ KR KS KT KU KV KW KX KY KZ
LA LB LC LD LE LF LG LH LI LJ LK LL LM LN LO LP LQ LR LS LT LU LV LW LX LY LZ
MA MB MC MD ME MF MG MH MI MJ MK ML MN MO MP MQ MR MS MT MU MV MW MX MY MZ
NA NB NC ND NE NF NG NH NI NJ NK NL NO NP NQ NR NS NT NU NV NW NX NY NZ
OA OB OC OD OE OF OG OH OI OJ OK OL OM ON OO OP OQ OR OS OT OU OV OW OX OY OZ
PA PB PC PD PE PF PG PH PI **PI** PK PL PM PN PO PP PQ PR PS PT PU PV PW PX PY PZ
QA QB QC QD QE QF QG QH QI QJ QK QL QM QN QO QP QQ QR QS QT QU QV QW QX QY QZ
RA RB RC RD RE RF RG RH RI RJ RK RL RM RN RO RP RQ RR RS RT RU RV RW RX RY RZ
SA SB SC SD SE SF SG SH SI SJ SK SL SM SN SO SP SQ SR SS ST SU SV SW SX SY SZ
TA TB TC TD TE TF TG TH TI TJ TK TL TM TN TO TP TQ TR TS TT TU TV TW TX TY TZ
UA UB UC UD UE UF UG UH UI UJ UK UL UM UN UO UP UQ UR US UT UU UV UW UX UY UZ
VA VB VC VD VE VF VG VH VI VJ VK VL VM VN VO VP VQ VR VS VT VU VW VX VY VZ
WA WB WC WD WE WF WG WH WI WJ WK WL WM WN WO WP WQ WR WS WT WU WV WW WX WY WZ
XA XB XC XD XE XF XG XH XI XJ XK XL XM XN XO XP XQ XR XS XT XU XV XW XX XY XZ
YA YB YC YD YE YF YG YH YI YJ YK YL YM YN YO YP YQ YR YS YT YU YV YW YX YY YZ
ZA ZB ZC ZD ZE ZF ZG ZH ZI ZJ ZK ZL ZM ZN ZO ZP ZQ ZR ZS ZT ZU ZV ZW ZX ZY ZZ

Zahnreiniger
Dental scalers
Limpiadores de sarro
Instruments à détartrer
Levatartari dentali



17,5 cm/7"



HYGIENIST
Fig.H6/H7
PI 045/06



Fig.T 2/3
PI 045/35

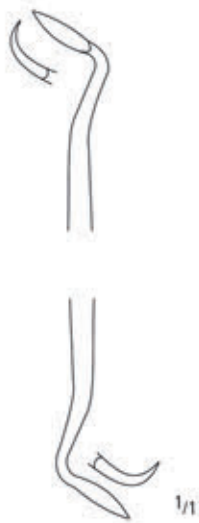

Fig.204
PI 045/36

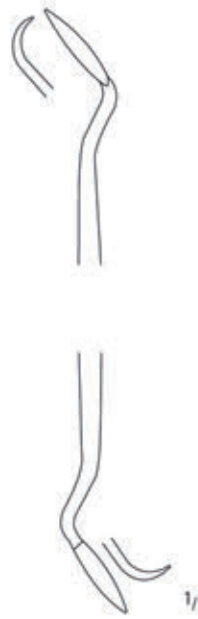

Fig.CI 2/3
PI 045/38

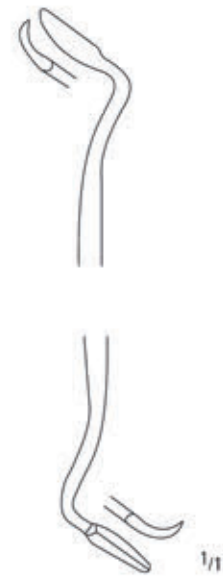

Fig.CC 6
PI 045/39

PARODONTOLOGIE
PERIODONTOLOGY
PARODONTOLOGIA
PARODONTOLOGIE
PARODONTOLOGIA

PK

nopa[®] instruments



Küretten, subgingival
Curettes, subgingival
Curetas, subgingival
Curettes, subgingival
Curette, subgingivale



McCALL
17,5 cm/7"

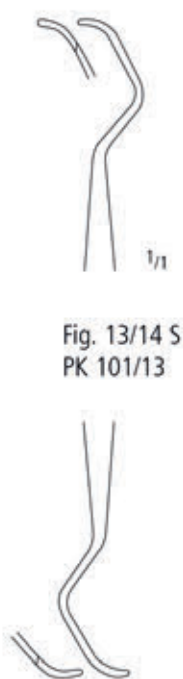

Fig. 13/14 S
PK 101/13

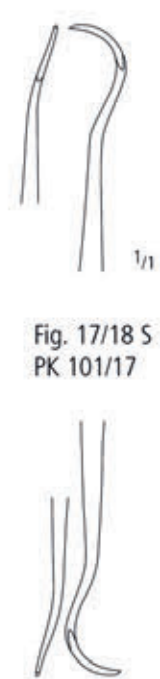

Fig. 17/18 S
PK 101/17



COLUMBIA
17,5 cm/7"

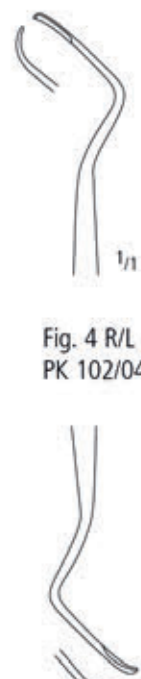

Fig. 4 R/L
PK 102/04

AA
AB
AC
AD
AE
AF
AK
AL
AO
AR
KA
KL
KU
PA
PB
PF
PI
PK
PL
PM
PP
PS
PT
PU
PV
KYE

Standard-Küretten, subgingival
 Standard-curettes, subgingival
 Curetas estándar, subgingival
 Curettes standard, subgingival
 Curette standard, subgingivale



GRACEY-STANDARD
 17,5 cm/7"



Fig. 1/2
 PK 104/02



Fig. 3/4
 PK 104/04



Fig. 5/6
 PK 104/06



Fig. 7/8
 PK 104/08



Fig. 9/10
 PK 104/10



Fig. 11/12
 PK 104/12



Fig. 13/14
 PK 104/14



Fig. 15/16
 PK 104/16



Küretten, subgingival
 Curettes, subgingival
 Curetas, subgingival
 Curettes, subgingival
 Curette, subgingivale



17,5 cm/7"



FIG. 1/2
 PK 105/02



FIG. 5/6
 PK 105/06



FIG. 3/4
 PK 105/04



AA
 AB
 AC
 AD
 AE
 AF
 AG
 AH
 AI
 AJ
 AK
 AL
 AM
 AN
 AO
 AP
 AQ
 AR
 AS
 AT
 AU
 AV
 AW
 AX
 AY
 AZ
 BA
 BB
 BC
 BD
 BE
 BF
 BG
 BH
 BI
 BJ
 BK
 BL
 BM
 BN
 BO
 BP
 BQ
 BR
 BS
 BT
 BU
 BV
 BV
 BW
 BX
 BY
 BZ
 CA
 CB
 CC
 CD
 CE
 CF
 CG
 CH
 CI
 CJ
 CK
 CL
 CM
 CN
 CO
 CP
 CQ
 CR
 CS
 CT
 CU
 CV
 CW
 CX
 CY
 CZ
 DA
 DB
 DC
 DD
 DE
 DF
 DG
 DH
 DI
 DJ
 DK
 DL
 DM
 DN
 DO
 DP
 DQ
 DR
 DS
 DT
 DU
 DV
 DW
 DX
 DY
 DZ
 EA
 EB
 EC
 ED
 EE
 EF
 EG
 EH
 EI
 EJ
 EK
 EL
 EM
 EN
 EO
 EP
 EQ
 ER
 ES
 ET
 EU
 EV
 EW
 EX
 EY
 EZ
 FA
 FB
 FC
 FD
 FE
 FF
 FG
 FH
 FI
 FJ
 FK
 FL
 FM
 FN
 FO
 FP
 FQ
 FR
 FS
 FT
 FU
 FV
 FW
 FX
 FY
 FZ
 GA
 GB
 GC
 GD
 GE
 GF
 GG
 GH
 GI
 GJ
 GK
 GL
 GM
 GN
 GO
 GP
 GQ
 GR
 GS
 GT
 GU
 GV
 GW
 GX
 GY
 GZ
 HA
 HB
 HC
 HD
 HE
 HF
 HG
 HH
 HI
 HJ
 HK
 HL
 HM
 HN
 HO
 HP
 HQ
 HR
 HS
 HT
 HU
 HV
 HW
 HX
 HY
 HZ
 IA
 IB
 IC
 ID
 IE
 IF
 IG
 IH
 II
 IJ
 IK
 IL
 IM
 IN
 IO
 IP
 IQ
 IR
 IS
 IT
 IU
 IV
 IW
 IX
 IY
 IZ
 JA
 JB
 JC
 JD
 JE
 JF
 JG
 JH
 JI
 JJ
 JK
 JL
 JM
 JN
 JO
 JP
 JQ
 JR
 JS
 JT
 JU
 JV
 JW
 JX
 JY
 JZ
 KA
 KB
 KC
 KD
 KE
 KF
 KG
 KH
 KI
 KJ
 KK
 KL
 KM
 KN
 KO
 KP
 KQ
 KR
 KS
 KT
 KU
 KV
 KW
 KX
 KY
 KZ
 LA
 LB
 LC
 LD
 LE
 LF
 LG
 LH
 LI
 LJ
 LK
 LL
 LM
 LN
 LO
 LP
 LQ
 LR
 LS
 LT
 LU
 LV
 LW
 LX
 LY
 LZ
 MA
 MB
 MC
 MD
 ME
 MF
 MG
 MH
 MI
 MJ
 MK
 ML
 MM
 MN
 MO
 MP
 MQ
 MR
 MS
 MT
 MU
 MV
 MW
 MX
 MY
 MZ
 NA
 NB
 NC
 ND
 NE
 NF
 NG
 NH
 NI
 NJ
 NK
 NL
 NM
 NN
 NO
 NP
 NQ
 NR
 NS
 NT
 NU
 NV
 NW
 NX
 NY
 NZ
 OA
 OB
 OC
 OD
 OE
 OF
 OG
 OH
 OI
 OJ
 OK
 OL
 OM
 ON
 OO
 OP
 OQ
 OR
 OS
 OT
 OU
 OV
 OW
 OX
 OY
 OZ
 PA
 PB
 PC
 PD
 PE
 PF
 PG
 PH
 PI
 PJ
 PK
 PL
 PM
 PN
 PO
 PP
 PQ
 PR
 PS
 PT
 PU
 PV
 PW
 PX
 PY
 PZ
 QA
 QB
 QC
 QD
 QE
 QF
 QG
 QH
 QI
 QJ
 QK
 QL
 QM
 QN
 QO
 QP
 QQ
 QR
 QS
 QT
 QU
 QV
 QW
 QX
 QY
 QZ
 RA
 RB
 RC
 RD
 RE
 RF
 RG
 RH
 RI
 RJ
 RK
 RL
 RM
 RN
 RO
 RP
 RQ
 RR
 RS
 RT
 RU
 RV
 RW
 RX
 RY
 RZ
 SA
 SB
 SC
 SD
 SE
 SF
 SG
 SH
 SI
 SJ
 SK
 SL
 SM
 SN
 SO
 SP
 SQ
 SR
 SS
 ST
 SU
 SV
 SW
 SX
 SY
 SZ
 TA
 TB
 TC
 TD
 TE
 TF
 TG
 TH
 TI
 TJ
 TK
 TL
 TM
 TN
 TO
 TP
 TQ
 TR
 TS
 TT
 TU
 TV
 TW
 TX
 TY
 TZ
 UA
 UB
 UC
 UD
 UE
 UF
 UG
 UH
 UI
 UJ
 UK
 UL
 UM
 UN
 UO
 UP
 UQ
 UR
 US
 UT
 UU
 UV
 UW
 UX
 UY
 UZ
 VA
 VB
 VC
 VD
 VE
 VF
 VG
 VH
 VI
 VJ
 VK
 VL
 VM
 VN
 VO
 VP
 VQ
 VR
 VS
 VT
 VU
 VV
 VW
 VX
 VY
 VZ
 WA
 WB
 WC
 WD
 WE
 WF
 WG
 WH
 WI
 WJ
 WK
 WL
 WM
 WN
 WO
 WP
 WQ
 WR
 WS
 WT
 WU
 WV
 WW
 WX
 WY
 WZ
 XA
 XB
 XC
 XD
 XE
 XF
 XG
 XH
 XI
 XJ
 XK
 XL
 XM
 XN
 XO
 XP
 XQ
 XR
 XS
 XT
 XU
 XV
 XW
 XX
 XY
 XZ
 YA
 YB
 YC
 YD
 YE
 YF
 YG
 YH
 YI
 YJ
 YK
 YL
 YM
 YN
 YO
 YP
 YQ
 YR
 YS
 YT
 YU
 YV
 YW
 YX
 YY
 YZ
 ZA
 ZB
 ZC
 ZD
 ZE
 ZF
 ZG
 ZH
 ZI
 ZJ
 ZK
 ZL
 ZM
 ZN
 ZO
 ZP
 ZQ
 ZR
 ZS
 ZT
 ZU
 ZV
 ZW
 ZX
 ZY
 ZZ

Sinus-Lift-Küretten
 Sinus lift curettes
 Curetas para sinus lift
 Curettes pour sinus lift
 Curette per sinus lift

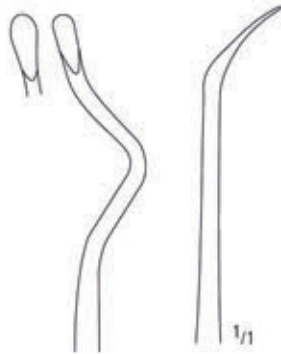

Fig. 1
 PK 108/01
 19,0 cm/7 1/2"



Fig. 2
 PK 108/02
 20,0 cm/8"

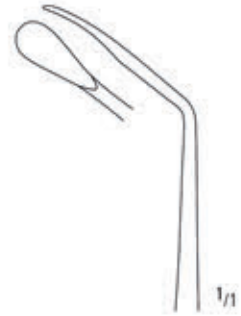

Fig. 3
 PK 108/03
 19,0 cm/7 1/2"



Fig. 4
 PK 108/04
 17,0 cm/6 3/4"

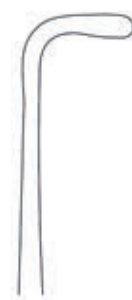
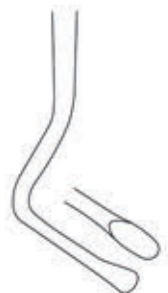
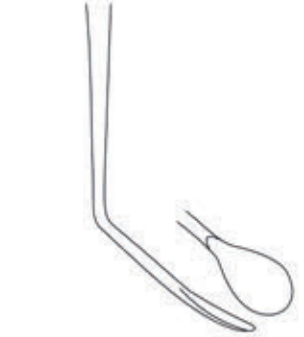

Fig. 5
 PK 108/05
 18,0 cm/7"



Scaler, supragingival
 Scalers, supragingival
 Limpiadores de sarro, supragingival
 Instruments à détartrer, supragingival
 Ablatori di tartaro, supragingival



GOLDMAN-FOX
 17,5 cm/7"



Fig. 1
 PK 110/01



Fig. 2
 PK 110/02



Fig. 3
 PK 110/03



Fig. 4
 PK 110/04



Fig. 5
 PK 110/05



Fig. 6
 PK 110/06

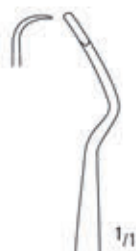

Fig. 4
 PK 110/04



Fig. 5
 PK 110/05



Fig. 6
 PK 110/06



Fig. 4
 PK 110/04



Fig. 5
 PK 110/05



Fig. 6
 PK 110/06

AA
 AB
 AC
 AD
 AE
 AF
 AG
 AH
 AI
 AJ
 AK
 AL
 AM
 AN
 AO
 AP
 AQ
 AR
 AS
 AT
 AU
 AV
 AW
 AX
 AY
 AZ
 BA
 BB
 BC
 BD
 BE
 BF
 BG
 BH
 BI
 BJ
 BK
 BL
 BM
 BN
 BO
 BP
 BQ
 BR
 BS
 BT
 BU
 BV
 BW
 BX
 BY
 BZ
 CA
 CB
 CC
 CD
 CE
 CF
 CG
 CH
 CI
 CJ
 CK
 CL
 CM
 CN
 CO
 CP
 CQ
 CR
 CS
 CT
 CU
 CV
 CW
 CX
 CY
 CZ
 DA
 DB
 DC
 DD
 DE
 DF
 DG
 DH
 DI
 DJ
 DK
 DL
 DM
 DN
 DO
 DP
 DQ
 DR
 DS
 DT
 DU
 DV
 DW
 DX
 DY
 DZ
 EA
 EB
 EC
 ED
 EE
 EF
 EG
 EH
 EI
 EJ
 EK
 EL
 EM
 EN
 EO
 EP
 EQ
 ER
 ES
 ET
 EU
 EV
 EW
 EX
 EY
 EZ
 FA
 FB
 FC
 FD
 FE
 FF
 FG
 FH
 FI
 FJ
 FK
 FL
 FM
 FN
 FO
 FP
 FQ
 FR
 FS
 FT
 FU
 FV
 FW
 FX
 FY
 FZ
 GA
 GB
 GC
 GD
 GE
 GF
 GG
 GH
 GI
 GJ
 GK
 GL
 GM
 GN
 GO
 GP
 GQ
 GR
 GS
 GT
 GU
 GV
 GW
 GX
 GY
 GZ
 HA
 HB
 HC
 HD
 HE
 HF
 HG
 HH
 HI
 HJ
 HK
 HL
 HM
 HN
 HO
 HP
 HQ
 HR
 HS
 HT
 HU
 HV
 HW
 HX
 HY
 HZ
 IA
 IB
 IC
 ID
 IE
 IF
 IG
 IH
 II
 IJ
 IK
 IL
 IM
 IN
 IO
 IP
 IQ
 IR
 IS
 IT
 IU
 IV
 IW
 IX
 IY
 IZ
 JA
 JB
 JC
 JD
 JE
 JF
 JG
 JH
 JI
 JJ
 JK
 JL
 JM
 JN
 JO
 JP
 JQ
 JR
 JS
 JT
 JU
 JV
 JW
 JX
 JY
 JZ
 KA
 KB
 KC
 KD
 KE
 KF
 KG
 KH
 KI
 KJ
 KK
 KL
 KM
 KN
 KO
 KP
 KQ
 KR
 KS
 KT
 KU
 KV
 KW
 KX
 KY
 KZ
 LA
 LB
 LC
 LD
 LE
 LF
 LG
 LH
 LI
 LJ
 LK
 LL
 LM
 LN
 LO
 LP
 LQ
 LR
 LS
 LT
 LU
 LV
 LW
 LX
 LY
 LZ
 MA
 MB
 MC
 MD
 ME
 MF
 MG
 MH
 MI
 MJ
 MK
 ML
 MM
 MN
 MO
 MP
 MQ
 MR
 MS
 MT
 MU
 MV
 MW
 MX
 MY
 MZ
 NA
 NB
 NC
 ND
 NE
 NF
 NG
 NH
 NI
 NJ
 NK
 NL
 NM
 NN
 NO
 NP
 NQ
 NR
 NS
 NT
 NU
 NV
 NW
 NX
 NY
 NZ
 OA
 OB
 OC
 OD
 OE
 OF
 OG
 OH
 OI
 OJ
 OK
 OL
 OM
 ON
 OO
 OP
 OQ
 OR
 OS
 OT
 OU
 OV
 OW
 OX
 OY
 OZ
 PA
 PB
 PC
 PD
 PE
 PF
 PG
 PH
 PI
 PJ
 PK
 PL
 PM
 PN
 PO
 PP
 PQ
 PR
 PS
 PT
 PU
 PV
 PW
 PX
 PY
 PZ
 QA
 QB
 QC
 QD
 QE
 QF
 QG
 QH
 QI
 QJ
 QK
 QL
 QM
 QN
 QO
 QP
 QQ
 QR
 QS
 QT
 QU
 QV
 QW
 QX
 QY
 QZ
 RA
 RB
 RC
 RD
 RE
 RF
 RG
 RH
 RI
 RJ
 RK
 RL
 RM
 RN
 RO
 RP
 RQ
 RR
 RS
 RT
 RU
 RV
 RW
 RX
 RY
 RZ
 SA
 SB
 SC
 SD
 SE
 SF
 SG
 SH
 SI
 SJ
 SK
 SL
 SM
 SN
 SO
 SP
 SQ
 SR
 SS
 ST
 SU
 SV
 SW
 SX
 SY
 SZ
 TA
 TB
 TC
 TD
 TE
 TF
 TG
 TH
 TI
 TJ
 TK
 TL
 TM
 TN
 TO
 TP
 TQ
 TR
 TS
 TT
 TU
 TV
 TW
 TX
 TY
 TZ
 UA
 UB
 UC
 UD
 UE
 UF
 UG
 UH
 UI
 UJ
 UK
 UL
 UM
 UN
 UO
 UP
 UQ
 UR
 US
 UT
 UY
 UZ
 VA
 VB
 VC
 VD
 VE
 VF
 VG
 VH
 VI
 VJ
 VK
 VL
 VM
 VN
 VO
 VP
 VQ
 VR
 VS
 VT
 VU
 VV
 VW
 VX
 VY
 VZ
 WA
 WB
 WC
 WD
 WE
 WF
 WG
 WH
 WI
 WJ
 WK
 WL
 WM
 WN
 WO
 WP
 WQ
 WR
 WS
 WT
 WU
 WV
 WW
 WX
 WY
 WZ
 XA
 XB
 XC
 XD
 XE
 XF
 XG
 XH
 XI
 XJ
 XK
 XL
 XM
 XN
 XO
 XP
 XQ
 XR
 XS
 XT
 XU
 XV
 XW
 XX
 XY
 XZ
 YA
 YB
 YC
 YD
 YE
 YF
 YG
 YH
 YI
 YJ
 YK
 YL
 YM
 YN
 YO
 YP
 YQ
 YR
 YS
 YT
 YU
 YV
 YW
 YX
 YZ
 ZA
 ZB
 ZC
 ZD
 ZE
 ZF
 ZG
 ZH
 ZI
 ZJ
 ZK
 ZL
 ZM
 ZN
 ZO
 ZP
 ZQ
 ZR
 ZS
 ZT
 ZU
 ZV
 ZW
 ZX
 ZY
 ZZ

Gingivektomiemesser
 Gingivectomy knives
 Bisturies para la gingivectomia
 Bistouris pour la gingivectomie
 Bisturie per gengivectomia



GOLDMAN-FOX
 17,5 cm/7"



Fig. 7
 PK 210/07



Fig. 8
 PK 210/08



Fig. 9
 PK 210/09



Fig. 10
 PK 210/10



Gingivektomiemesser
 Gingivectomy knives
 Bisturios para la gingivectomia
 Bistouris pour la gingivectomie
 Bisturie per gengivectomia



KIRKLAND
PK 220/15



KIRKLAND
PK 220/16



ORBAN
PK 222/01
Fig. 1

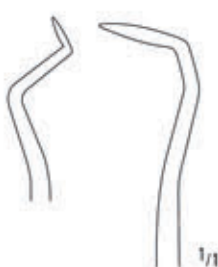

ORBAN
PK 222/02
Fig. 2

17,5 cm/7"



KIRKLAND
PK 221/00



ORBAN
PK 222/03
Fig. 1/2



17,5 cm/7"

AA
AB
AC
AD
AE
AF
AK
AL
AO
AR
KA
KL
KU
PA
PB
PF
PI
PK
PL
PM
PP
PS
PT
PU
PV
KYE

Parodontalmeißel
 Periodontal chisels
 Cinceles de periodoncia
 Burins de parodontie
 Sgorbie per parodontologia

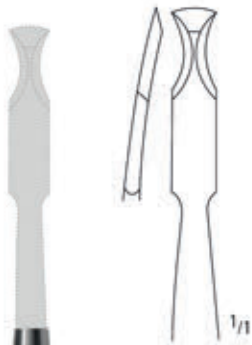

Fig. 1
 PK 357/01

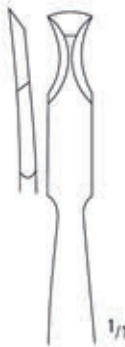

Fig. 2
 PK 357/02



OCHSENBEIN
 17,0 cm/6³/₄"



Fig. 3
 PK 357/03

Fig. 4
 PK 357/04



OCHSENBEIN
 17,5 cm/7"

Raspatorien
Raspatories
Raspadores
Rugines-Raspatoires
Peristotomi



Fig. 8
PK 400/08

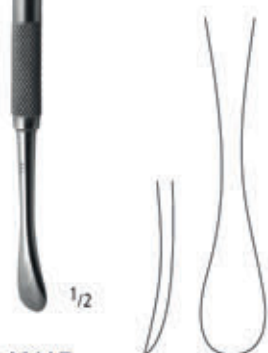
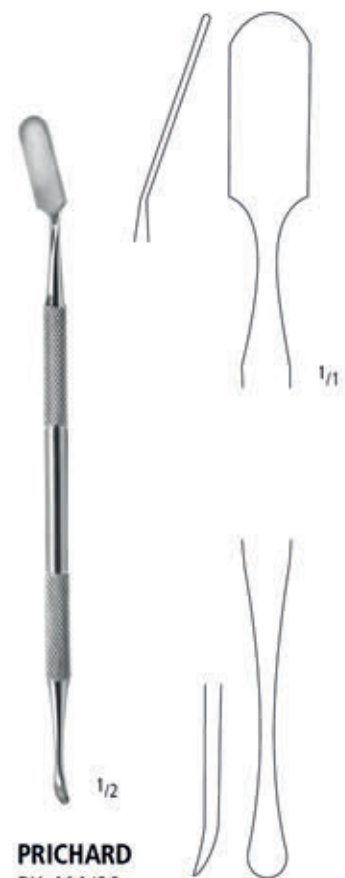

Fig. 9
PK 400/09

MOLT
18,0 cm/7"

MOLT
18,0 cm/7"



PRICHARD
PK 411/00
18,0 cm/7"



SELDIN
PK 412/23
18 cm/7"

AA
AB
AC
AD
AE
AF
AK
AL
AO
AR
KA
KL
KU
PA
PB
PF
PI
PK
PL
PM
PP
PS
PT
PU
PV
KYE

Raspatorien
 Raspatories
 Raspadores
 Rugines-Raspatoires
 Peristotomi



WEST
 PK 415/00
 18,0 cm/7"



OHL
 PK 417/00
 18,0 cm/7"

Knochenfeilen
 Bone files
 Limas para huesos
 Limes à os
 Lime per ossa



MILLER-COLBURN
 18,0 cm / 7"



Fig. 1
 PK 420/01



Fig. 2
 PK 420/02

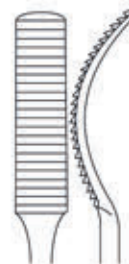

Fig. 3
 PK 420/03

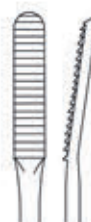
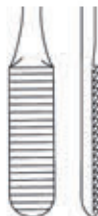

Fig. 4
 PK 420/04



Fig. 5
 PK 420/05



AA
 AB
 AC
 AD
 AE
 AF
 AK
 AL
 AO
 AR
 KA
 KL
 KU
 PA
 PB
 PF
 PJ
PK
 PL
 PM
 PP
 PS
 PT
 PU
 PV
 KYE

Knochenfeilen
 Bone files
 Limas para huesos
 Limes à os
 Lime per ossa



MILLER-COLBURN
 18,0 cm / 7"



Fig. 1
 PK 421/01



Fig. 2
 PK 421/02

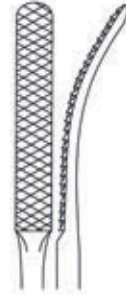

Fig. 3
 PK 421/03



Fig. 4
 PK 421/04

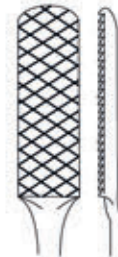

Fig. 5
 PK 421/05



Knochenfeilen
 Bone files
 Limas para huesos
 Limes à os
 Lime per ossa



17,5 cm/7"



Fig. 3/7
 PK 422/07



Fig. 5/11
 PK 422/11



AA
 AB
 AC
 AD
 AE
 AF
 AG
 AH
 AI
 AJ
 AK
 AL
 AM
 AN
 AO
 AP
 AQ
 AR
 AS
 AT
 AU
 AV
 AW
 AX
 AY
 AZ
 BA
 BB
 BC
 BD
 BE
 BF
 BG
 BH
 BI
 BJ
 BK
 BL
 BM
 BN
 BO
 BP
 BQ
 BR
 BS
 BT
 BU
 BV
 BW
 BX
 BY
 BZ
 CA
 CB
 CC
 CD
 CE
 CF
 CG
 CH
 CI
 CJ
 CK
 CL
 CM
 CN
 CO
 CP
 CQ
 CR
 CS
 CT
 CU
 CV
 CW
 CX
 CY
 CZ
 DA
 DB
 DC
 DD
 DE
 DF
 DG
 DH
 DI
 DJ
 DK
 DL
 DM
 DN
 DO
 DP
 DQ
 DR
 DS
 DT
 DU
 DV
 DW
 DX
 DY
 DZ
 EA
 EB
 EC
 ED
 EE
 EF
 EG
 EH
 EI
 EJ
 EK
 EL
 EM
 EN
 EO
 EP
 EQ
 ER
 ES
 ET
 EU
 EV
 EW
 EX
 EY
 EZ
 FA
 FB
 FC
 FD
 FE
 FF
 FG
 FH
 FI
 FJ
 FK
 FL
 FM
 FN
 FO
 FP
 FQ
 FR
 FS
 FT
 FU
 FV
 FW
 FX
 FY
 FZ
 GA
 GB
 GC
 GD
 GE
 GF
 GG
 GH
 GI
 GJ
 GK
 GL
 GM
 GN
 GO
 GP
 GQ
 GR
 GS
 GT
 GU
 GV
 GW
 GX
 GY
 GZ
 HA
 HB
 HC
 HD
 HE
 HF
 HG
 HH
 HI
 HJ
 HK
 HL
 HM
 HN
 HO
 HP
 HQ
 HR
 HS
 HT
 HU
 HV
 HW
 HX
 HY
 HZ
 IA
 IB
 IC
 ID
 IE
 IF
 IG
 IH
 II
 IJ
 IK
 IL
 IM
 IN
 IO
 IP
 IQ
 IR
 IS
 IT
 IU
 IV
 IW
 IX
 IY
 IZ
 JA
 JB
 JC
 JD
 JE
 JF
 JG
 JH
 JI
 JJ
 JK
 JL
 JM
 JN
 JO
 JP
 JQ
 JR
 JS
 JT
 JU
 JV
 JW
 JX
 JY
 JZ
 KA
 KB
 KC
 KD
 KE
 KF
 KG
 KH
 KI
 KJ
 KK
 KL
 KM
 KN
 KO
 KP
 KQ
 KR
 KS
 KT
 KU
 KV
 KW
 KX
 KY
 KZ
 LA
 LB
 LC
 LD
 LE
 LF
 LG
 LH
 LI
 LJ
 LK
 LL
 LM
 LN
 LO
 LP
 LQ
 LR
 LS
 LT
 LU
 LV
 LW
 LX
 LY
 LZ
 MA
 MB
 MC
 MD
 ME
 MF
 MG
 MH
 MI
 MJ
 MK
 ML
 MM
 MN
 MO
 MP
 MQ
 MR
 MS
 MT
 MU
 MV
 MW
 MX
 MY
 MZ
 NA
 NB
 NC
 ND
 NE
 NF
 NG
 NH
 NI
 NJ
 NK
 NL
 NM
 NN
 NO
 NP
 NQ
 NR
 NS
 NT
 NU
 NV
 NW
 NX
 NY
 NZ
 OA
 OB
 OC
 OD
 OE
 OF
 OG
 OH
 OI
 OJ
 OK
 OL
 OM
 ON
 OO
 OP
 OQ
 OR
 OS
 OT
 OU
 OV
 OW
 OX
 OY
 OZ
 PA
 PB
 PC
 PD
 PE
 PF
 PG
 PH
 PI
 PJ
 PK
 PL
 PM
 PN
 PO
 PP
 PQ
 PR
 PS
 PT
 PU
 PV
 PW
 PX
 PY
 PZ
 QA
 QB
 QC
 QD
 QE
 QF
 QG
 QH
 QI
 QJ
 QK
 QL
 QM
 QN
 QO
 QP
 QQ
 QR
 QS
 QT
 QU
 QV
 QW
 QX
 QY
 QZ
 RA
 RB
 RC
 RD
 RE
 RF
 RG
 RH
 RI
 RJ
 RK
 RL
 RM
 RN
 RO
 RP
 RQ
 RR
 RS
 RT
 RU
 RV
 RW
 RX
 RY
 RZ
 SA
 SB
 SC
 SD
 SE
 SF
 SG
 SH
 SI
 SJ
 SK
 SL
 SM
 SN
 SO
 SP
 SQ
 SR
 SS
 ST
 SU
 SV
 SW
 SX
 SY
 SZ
 TA
 TB
 TC
 TD
 TE
 TF
 TG
 TH
 TI
 TJ
 TK
 TL
 TM
 TN
 TO
 TP
 TQ
 TR
 TS
 TT
 TU
 TV
 TW
 TX
 TY
 TZ
 UA
 UB
 UC
 UD
 UE
 UF
 UG
 UH
 UI
 UJ
 UK
 UL
 UM
 UN
 UO
 UP
 UQ
 UR
 US
 UT
 UY
 UZ
 VA
 VB
 VC
 VD
 VE
 VF
 VG
 VH
 VI
 VJ
 VK
 VL
 VM
 VN
 VO
 VP
 VQ
 VR
 VS
 VT
 VU
 VV
 VW
 VX
 VY
 VZ
 WA
 WB
 WC
 WD
 WE
 WF
 WG
 WH
 WI
 WJ
 WK
 WL
 WM
 WN
 WO
 WP
 WQ
 WR
 WS
 WT
 WU
 WV
 WW
 WX
 WY
 WZ
 XA
 XB
 XC
 XD
 XE
 XF
 XG
 XH
 XI
 XJ
 XK
 XL
 XM
 XN
 XO
 XP
 XQ
 XR
 XS
 XT
 XU
 XV
 XW
 XX
 XY
 XZ
 YA
 YB
 YC
 YD
 YE
 YF
 YG
 YH
 YI
 YJ
 YK
 YL
 YM
 YN
 YO
 YP
 YQ
 YR
 YS
 YT
 YU
 YV
 YW
 YX
 YZ
 ZA
 ZB
 ZC
 ZD
 ZE
 ZF
 ZG
 ZH
 ZI
 ZJ
 ZK
 ZL
 ZM
 ZN
 ZO
 ZP
 ZQ
 ZR
 ZS
 ZT
 ZU
 ZV
 ZW
 ZX
 ZY
 ZZ

SONDEN
PROBES
SONDAS
SONDES
SONDE

PL

nopa[®] instruments



SONDEN PROBES SONDAS SONDES SONDE

Zahnsonden
Explorers
Sondas
Sondes
Sonde



17,5 cm/7"



Fig. 3
PL 060/03



Fig. 6
PL 060/06



Fig. 6XL
PL 060/07



Fig. 8
PL 060/08



Fig. 9
PL 060/09



Fig. 17
PL 060/17



Fig. 23
PL 060/23

AA
AB
AC
AD
AE
AF
AG
AH
AI
AJ
AK
AL
AM
AN
AO
AP
AQ
AR
AS
AT
AU
AV
AW
AX
AY
AZ
BA
BB
BC
BD
BE
BF
BG
BH
BI
BJ
BK
BL
BM
BN
BO
BP
BQ
BR
BS
BT
BU
BV
BW
BX
BY
BZ
CA
CB
CC
CD
CE
CF
CG
CH
CI
CJ
CK
CL
CM
CN
CO
CP
CQ
CR
CS
CT
CU
CV
CW
CX
CY
CZ
DA
DB
DC
DD
DE
DF
DG
DH
DI
DJ
DK
DL
DM
DN
DO
DP
DQ
DR
DS
DT
DU
DV
DW
DX
DY
DZ
EA
EB
EC
ED
EE
EF
EG
EH
EI
EJ
EK
EL
EM
EN
EO
EP
EQ
ER
ES
ET
EU
EV
EW
EX
EY
EZ
FA
FB
FC
FD
FE
FF
FG
FH
FI
FJ
FK
FL
FM
FN
FO
FP
FQ
FR
FS
FT
FU
FV
FW
FX
FY
FZ
GA
GB
GC
GD
GE
GF
GG
GH
GI
GJ
GK
GL
GM
GN
GO
GP
GQ
GR
GS
GT
GU
GV
GW
GX
GY
GZ
HA
HB
HC
HD
HE
HF
HG
HH
HI
HJ
HK
HL
HM
HN
HO
HP
HQ
HR
HS
HT
HU
HV
HW
HX
HY
HZ
IA
IB
IC
ID
IE
IF
IG
IH
II
IJ
IK
IL
IM
IN
IO
IP
IQ
IR
IS
IT
IU
IV
IW
IX
IY
IZ
JA
JB
JC
JD
JE
JF
JG
JH
JI
JJ
JK
JL
JM
JN
JO
JP
JQ
JR
JS
JT
JU
JV
JW
JX
JY
JZ
KA
KB
KC
KD
KE
KF
KG
KH
KI
KJ
KK
KL
KM
KN
KO
KP
KQ
KR
KS
KT
KU
KV
KW
KX
KY
KZ
LA
LB
LC
LD
LE
LF
LG
LH
LI
LJ
LK
LL
LM
LN
LO
LP
LQ
LR
LS
LT
LU
LV
LW
LX
LY
LZ
MA
MB
MC
MD
ME
MF
MG
MH
MI
MJ
MK
ML
MM
MN
MO
MP
MQ
MR
MS
MT
MU
MV
MW
MX
MY
MZ
NA
NB
NC
ND
NE
NF
NG
NH
NI
NJ
NK
NL
NM
NN
NO
NP
NQ
NR
NS
NT
NU
NV
NW
NX
NY
NZ
OA
OB
OC
OD
OE
OF
OG
OH
OI
OJ
OK
OL
OM
ON
OO
OP
OQ
OR
OS
OT
OU
OV
OW
OX
OY
OZ
PA
PB
PC
PD
PE
PF
PG
PH
PI
PJ
PK
PL
PM
PN
PO
PP
PQ
PR
PS
PT
PU
PV
PW
PX
PY
PZ
QA
QB
QC
QD
QE
QF
QG
QH
QI
QJ
QK
QL
QM
QN
QO
QP
QQ
QR
QS
QT
QU
QV
QW
QX
QY
QZ
RA
RB
RC
RD
RE
RF
RG
RH
RI
RJ
RK
RL
RM
RN
RO
RP
RQ
RR
RS
RT
RU
RV
RW
RX
RY
RZ
SA
SB
SC
SD
SE
SF
SG
SH
SI
SJ
SK
SL
SM
SN
SO
SP
SQ
SR
SS
ST
SU
SV
SW
SX
SY
SZ
TA
TB
TC
TD
TE
TF
TG
TH
TI
TJ
TK
TL
TM
TN
TO
TP
TQ
TR
TS
TT
TU
TV
TW
TX
TY
TZ
UA
UB
UC
UD
UE
UF
UG
UH
UI
UJ
UK
UL
UM
UN
UO
UP
UQ
UR
US
UT
UU
UV
UW
UX
UY
UZ
VA
VB
VC
VD
VE
VF
VG
VH
VI
VJ
VK
VL
VM
VN
VO
VP
VQ
VR
VS
VT
VU
VV
VW
VX
VY
VZ
WA
WB
WC
WD
WE
WF
WG
WH
WI
WJ
WK
WL
WM
WN
WO
WP
WQ
WR
WS
WT
WU
WV
WW
WX
WY
WZ
XA
XB
XC
XD
XE
XF
XG
XH
XI
XJ
XK
XL
XM
XN
XO
XP
XQ
XR
XS
XT
XU
XV
XW
XX
XY
XZ
YA
YB
YC
YD
YE
YF
YG
YH
YI
YJ
YK
YL
YM
YN
YO
YP
YQ
YR
YS
YT
YU
YV
YW
YX
YY
YZ
ZA
ZB
ZC
ZD
ZE
ZF
ZG
ZH
ZI
ZJ
ZK
ZL
ZM
ZN
ZO
ZP
ZQ
ZR
ZS
ZT
ZU
ZV
ZW
ZX
ZY
ZZ

PL

Zahnsonden
Explorers
Sondas
Sondes
Sonde



17,5 cm/7"



Fig. 2/2
PL 211/02



Fig. 3/3
PL 211/03



Fig. 5/6
PL 211/05



Fig. 23/6
PL 211/06

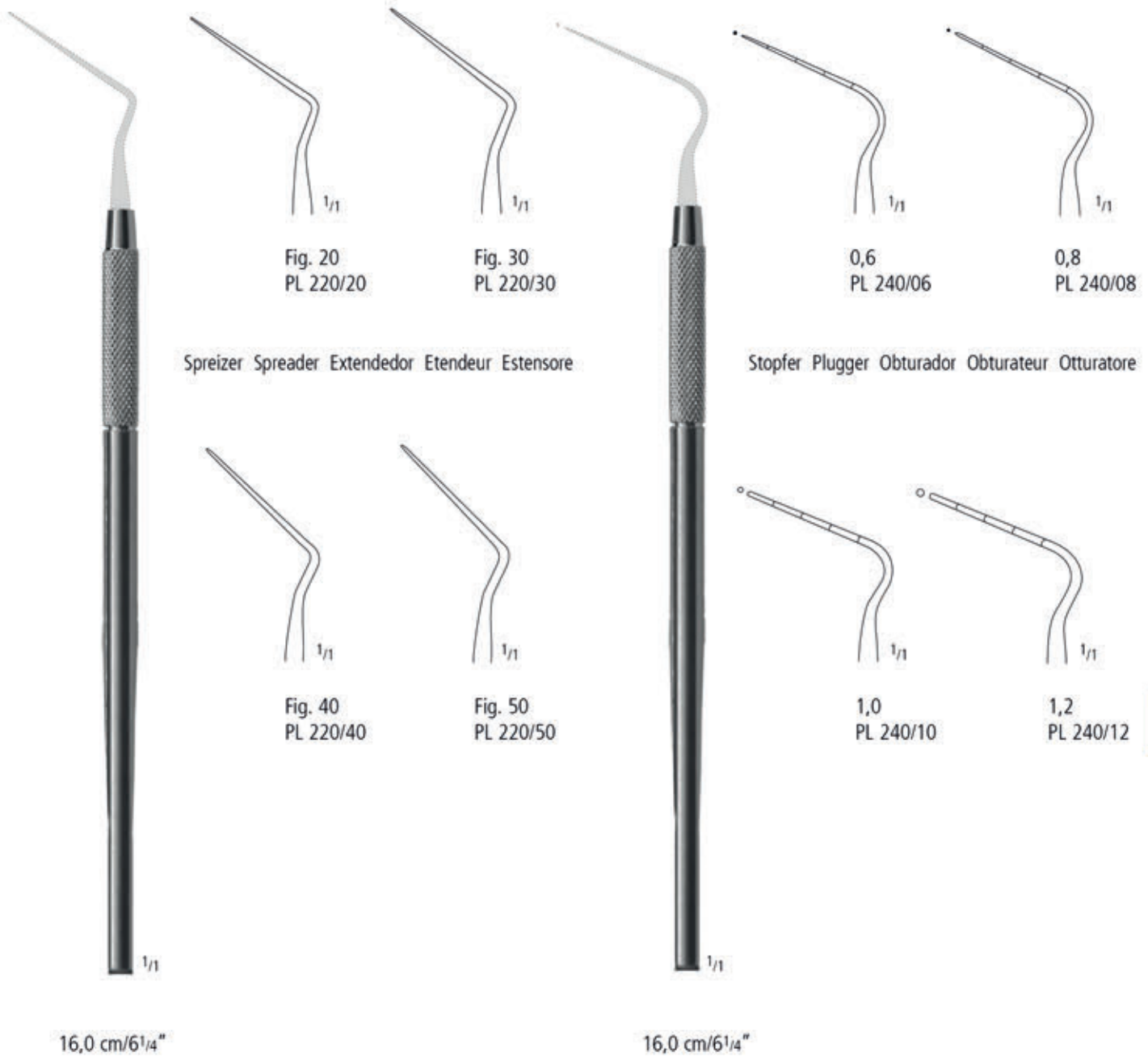

Fig. 17/23
PL 211/17



SONDEN PROBES SONDAS SONDES SONDE

Spreizer, Wurzelkanalstopfer
 Spreader, root canal plugger
 Extendedor, obturador
 Etendeur, fouloir à canaux
 Estensore, otturatore



AA
AB
AC
AD
AE
AF
AK
AL
AO
AR
KA
KL
KU
PA
PB
PF
PI
PK
PL
PM
PP
PS
PT
PU
PV
KYE

Parodontometer
 Periodontal probes
 Sondas parodontales
 Sondes parodontales
 Sonde parodontali



16,0 cm/6 1/4"



Fig. 11
 Grad. 3-6-8-11
 PL 251/11



Fig. 12
 Grad. 3-6-9-12
 PL 251/12



OMS
 Fig. CPG 12
 Grad. 3-6-9-12
 PL 251/22



Fig. 15
 Grad. 1-2-3-5-7-8-9-10-11-12-13-14-15
 PL 251/15



Fig. 18
 Grad. 3-5-8-10
 PL 251/18



WHO
 Fig. CPG 11,5
 Grad. 3,5-5,5-8,5-11,5
 PL 251/23



Fig 10
 Grad. 1-2-3-5-7-8-9-10
 PL 251/24



Fig. W
 Grad. 1-2-3-5-7-9-10
 PL 251/25



16,0 cm/6 1/4"

EXKAVATOREN
EXCAVATORS
EXCAVADORES
EXCAVATEURS
ESCAVATORI

PM

nopa[®] instruments



EXKAVATOREN EXCAVATORS EXCAVADORES EXCAVATEURS ESCAVATORI

Exkavatoren
Excavators
Excavadores
Excavateurs
Escavatori



17,5 cm/7"



Fig. 0
PM 100/00



Fig. 1
PM 100/01



Fig. 2
PM 100/02



Fig. 3
PM 100/03



Fig. 4
PM 100/04



AA
AB
AC
AD
AE
AF
AK
AL
AO
AR
KA
KL
KU
PA
PB
PF
PI
PK
PL
PM
PP
PS
PT
PU
PV
KYE

Exkavatoren
Excavators
Excavadores
Excavateurs
Escavatori



WHITE
17,5 cm/7"



Fig. 17
PM 120/17



Fig. 18
PM 120/18



Fig. 19
PM 120/19



EXKAVATOREN EXCAVATORS EXCAVADORES EXCAVATEURS ESCAVATORI

Exkavatoren
Excavators
Excavadores
Excavateurs
Escavatori



17,5 cm/7"



Fig. 17
PM 121/17



Fig. 18
PM 121/18



Fig.19
PM 121/19



Fig. 31L
PM 121/31



Fig. 32L
PM 121/32



Fig. 33L
PM 121/33



AA
AB
AC
AD
AE
AF
AK
AL
AO
AR
KA
KL
KU
PA
PB
PF
PI
PK
PL
PM
PP
PS
PT
PU
PV
KYE

Exkavatoren
Excavators
Excavadores
Excavateurs
Escavatori



DERBY-PERRY
17,5 cm/7"



Fig. 5/6
PM 123/05



Fig. 7/8
PM 123/06



Fig. 9/10
PM 123/07



Fig. 11/12
PM 123/08



Fig. 13/14
PM 123/09



Fig. 15/16
PM 123/10



SCHMELZMEISSEL
ENAMEL CHISELS
CINCELES PARA ESMALTE
CISEAUX A EMAIL
TAGLIASMALTO

PP

nopa[®] instruments



SCHMELZMEISSEL ENAMEL CHISELS CINCELES PARA ESMALTE CISEAUX A EMAIL TAGLIASMALTO

Schmelzmeißel
Enamel chisels
Cinceles para esmalte
Ciseaux à émail
Tagliasmaltos



BLACK
17,5 cm/7"



Fig. 51/52
PP 110/51



Fig. 53/54
PP 110/53



Fig. 63/64
PP 110/63



Fig. 65/66
PP 110/65



Fig. 77/78
PP 110/77



Fig. 79/80
PP 110/79



AA
AB
AC
AD
AE
AF
AK
AL
AO
AR
KA
KL
KU
PA
PB
PF
PI
PK
PL
PM
PP
PS
PT
PU
PV
KYE

Schmelzmeißel
 Enamel chisels
 Cinceles para esmalte
 Ciseaux à émail
 Tagliasmaltes



WEDELSTAEDT
 17,5 cm/7"



Fig. 1/2
 PP 120/01



Fig. 3/4
 PP 120/03



Fig. 5/6
 PP 120/06



FÜLLUNGSINSTRUMENTE
FILLING INSTRUMENTS
INSTRUMENTOS PARA OBTURACIONES
INSTRUMENTS POUR PLOMBAGES
OTTURATORI

PS

nopa[®] instruments



Füllungsinstrumente
Filling instruments
Instrumentos para obturaciones
Instruments pour plombages
Otturatori



HOLLERBACK
17,5 cm/7"



Fig. 1
PS 010/01



Fig. 2
PS 010/02



Fig. 3
PS 010/03



Fig. 4
PS 010/04



AA
AB
AC
AD
AE
AF
AK
AL
AO
AR
KA
KL
KU
PA
PB
PF
PI
PK
PL
PM
PP
PS
PT
PU
PV
KYE

Füllungsinstrumente
 Filling instruments
 Instrumentos para obturaciones
 Instruments pour plombages
 Otturatori



17,5 cm/7"



Fig. 1P
 PS 011/00



Fig. 3P
 PS 011/01



Fig. 4P
 PS 012/00



Fig. 3S
 PS 013/03



Fig. 4S
 PS 013/04



Planstopfer
Plane condenser
Condensador plano
Obturateur plan
Otturatore piano



17,5 cm/7"



Fig. 1S
PS 020/01



Fig. 2S
PS 020/02



Fig. 3S
PS 020/03



AA
AB
AC
AD
AE
AF
AG
AH
AI
AJ
AK
AL
AM
AN
AO
AP
AQ
AR
AS
AT
AU
AV
AW
AX
AY
AZ
BA
BB
BC
BD
BE
BF
BG
BH
BI
BJ
BK
BL
BM
BN
BO
BP
BQ
BR
BS
BT
BU
BV
BW
BX
BY
BZ
CA
CB
CC
CD
CE
CF
CG
CH
CI
CJ
CK
CL
CM
CN
CO
CP
CQ
CR
CS
CT
CU
CV
CW
CX
CY
CZ
DA
DB
DC
DD
DE
DF
DG
DH
DI
DJ
DK
DL
DM
DN
DO
DP
DQ
DR
DS
DT
DU
DV
DW
DX
DY
DZ
EA
EB
EC
ED
EE
EF
EG
EH
EI
EJ
EK
EL
EM
EN
EO
EP
EQ
ER
ES
ET
EU
EV
EW
EX
EY
EZ
FA
FB
FC
FD
FE
FF
FG
FH
FI
FJ
FK
FL
FM
FN
FO
FP
FQ
FR
FS
FT
FU
FV
FW
FX
FY
FZ
GA
GB
GC
GD
GE
GF
GG
GH
GI
GJ
GK
GL
GM
GN
GO
GP
GQ
GR
GS
GT
GU
GV
GW
GX
GY
GZ
HA
HB
HC
HD
HE
HF
HG
HH
HI
HJ
HK
HL
HM
HN
HO
HP
HQ
HR
HS
HT
HU
HV
HW
HX
HY
HZ
IA
IB
IC
ID
IE
IF
IG
IH
II
IJ
IK
IL
IM
IN
IO
IP
IQ
IR
IS
IT
IU
IV
IW
IX
IY
IZ
JA
JB
JC
JD
JE
JF
JG
JH
JI
JJ
JK
JL
JM
JN
JO
JP
JQ
JR
JS
JT
JU
JV
JW
JX
JY
JZ
KA
KB
KC
KD
KE
KF
KG
KH
KI
KJ
KK
KL
KM
KN
KO
KP
KQ
KR
KS
KT
KU
KV
KW
KX
KY
KZ
LA
LB
LC
LD
LE
LF
LG
LH
LI
LJ
LK
LL
LM
LN
LO
LP
LQ
LR
LS
LT
LU
LV
LW
LX
LY
LZ
MA
MB
MC
MD
ME
MF
MG
MH
MI
MJ
MK
ML
MM
MN
MO
MP
MQ
MR
MS
MT
MU
MV
MW
MX
MY
MZ
NA
NB
NC
ND
NE
NF
NG
NH
NI
NJ
NK
NL
NM
NN
NO
NP
NQ
NR
NS
NT
NU
NV
NW
NX
NY
NZ
OA
OB
OC
OD
OE
OF
OG
OH
OI
OJ
OK
OL
OM
ON
OO
OP
OQ
OR
OS
OT
OU
OV
OW
OX
OY
OZ
PA
PB
PC
PD
PE
PF
PG
PH
PI
PJ
PK
PL
PM
PN
PO
PP
PQ
PR
PS
PT
PU
PV
PW
PX
PY
PZ
QA
QB
QC
QD
QE
QF
QG
QH
QI
QJ
QK
QL
QM
QN
QO
QP
QQ
QR
QS
QT
QU
QV
QW
QX
QY
QZ
RA
RB
RC
RD
RE
RF
RG
RH
RI
RJ
RK
RL
RM
RN
RO
RP
RQ
RR
RS
RT
RU
RV
RW
RX
RY
RZ
SA
SB
SC
SD
SE
SF
SG
SH
SI
SJ
SK
SL
SM
SN
SO
SP
SQ
SR
SS
ST
SU
SV
SW
SX
SY
SZ
TA
TB
TC
TD
TE
TF
TG
TH
TI
TJ
TK
TL
TM
TN
TO
TP
TQ
TR
TS
TT
TU
TV
TW
TX
TY
TZ
UA
UB
UC
UD
UE
UF
UG
UH
UI
UJ
UK
UL
UM
UN
UO
UP
UQ
UR
US
UT
UU
UV
UW
UX
UY
UZ
VA
VB
VC
VD
VE
VF
VG
VH
VI
VJ
VK
VL
VM
VN
VO
VP
VQ
VR
VS
VT
VU
VV
VW
VX
VY
VZ
WA
WB
WC
WD
WE
WF
WG
WH
WI
WJ
WK
WL
WM
WN
WO
WP
WQ
WR
WS
WT
WU
WV
WW
WX
WY
WZ
XA
XB
XC
XD
XE
XF
XG
XH
XI
XJ
XK
XL
XM
XN
XO
XP
XQ
XR
XS
XT
XU
XV
XW
XX
XY
XZ
YA
YB
YC
YD
YE
YF
YG
YH
YI
YJ
YK
YL
YM
YN
YO
YP
YQ
YR
YS
YT
YU
YV
YW
YX
YY
YZ
ZA
ZB
ZC
ZD
ZE
ZF
ZG
ZH
ZI
ZJ
ZK
ZL
ZM
ZN
ZO
ZP
ZQ
ZR
ZS
ZT
ZU
ZV
ZW
ZX
ZY
ZZ

Kompositinstrumente
Composite instruments
Instrumentos para composites
Instruments pour composites
Strumenti composito

TINI[®] = TI

Arbeitsenden Titan-Nitrit beschichtet (TINI[®])
Working ends Titanium-Nitride coating (TINI[®])



Füllungsinstrumente
Filling instruments
Instrumentos para obturaciones
Instruments pour plombages
Otturatori



HEIDEMANN
18,0 cm/7"



Fig. 1
PS 030/01
PS 030/01**TI**



2,0 mm



Fig. 2
PS 030/02
PS 030/02**TI**



2,5 mm



Fig. 3
PS 030/03
PS 030/03**TI**



3,0 mm



USA
17,5 cm/7"



Fig. 1
PS 040/01
PS 040/01**TI**



Fig. 2
PS 040/02
PS 040/02**TI**



AA
AB
AC
AD
AE
AF
AK
AL
AO
AR
KA
KL
KU
PA
PB
PF
PI
PK
PL
PM
PP
PS
PT
PU
PV
KYE

Füllungsinstrumente
 Filling instruments
 Instrumentos para obturaciones
 Instruments pour plombages
 Otturatori



WOODSON
 18,0 cm/7"



Fig. 1
 PS 070/01



Fig. 2
 PS 070/02



Fig. 3
 PS 070/03



Planstopfer, Füllungsinstrumente
 Plane condenser, filling instruments
 Condensador plano, instrumentos para obturaciones
 Obturateur plan, instruments pour plombages
 Otturatore piano, otturatori



17,5 cm/7"



Fig. 1
PS 090/01



Fig. 2
PS 090/02



Fig. 3
PS 090/03



Fig. 1D
PS 100/01
PS 100/01TI



Fig. 2D
PS 100/02
PS 100/02TI



Fig. T 1
PS 100/03
PS 100/03TI



Füllungsinstrumente
 Filling instruments
 Instrumentos para obturaciones
 Instruments pour plombages
 Otturatori



17,0 cm/6³/₄"



Fig. 26/27S
 PS 102/26



Fig. 27/29
 PS 102/27



Fig. 28/29
 PS 102/28



Fig. 7A
 PS 104/00



Kugelstopfer
Ball type condenser
Condensador tipo bola
Obturateur à bille
Otturatore a sfera



17,0 cm/6³/₄"



Fig. 1
PS 110/01



Fig. 2
PS 110/02



Fig. 3
PS 110/03



Fig. 4
PS 110/04



Fig. 5
PS 110/05



AA
AB
AC
AD
AE
AF
AK
AL
AO
AR
KA
KL
KU
PA
PB
PF
PI
PK
PL
PM
PP
PS
PT
PU
PV
KYE

Kugel/Spatel-Kombination
 Ball/spatula combination
 Combinación bola/espátula
 Combinaison bille/spatule
 Combinazione sfera/spatola



17,0 cm/6³/₄"



Fig. 1
PS 115/01



Fig. 2
PS 115/02



Fig. 3
PS 115/03



Spatel
Spatula
Espátula
Spatule
Spatola



17,5 cm/7"



Fig. 1
PS 120/01



Fig. 2
PS 120/02



Fig. 3
PS 120/03



Fig. 6
PS 120/06



Fig. 12
PS 120/12



AA
AB
AC
AD
AE
AF
AK
AL
AO
AR
KA
KL
KU
PA
PB
PF
PI
PK
PL
PM
PP
PS
PT
PU
PV
KYE

Füllungsinstrumente
Filling instruments
Instrumentos para obturaciones
Instruments pour plombages
Otturatori



BENNET
PS 150/07



Elefantfußstopfer
Elephant foot condenser
Condensador pie de elefante
Obturateur pied d'éléphant
Otturatore a piede di elefante

PS 160/00
16,5 cm/6 1/2"



17,5 cm/7"

Amalgaminstrumente
Amalgam instruments
Instrumentos amalgamas
Instruments à amalgame
Strumenti per amalgama



PS 180/01



PS 180/02

Kunststoffansatz
Plastic tip



PS 181/01

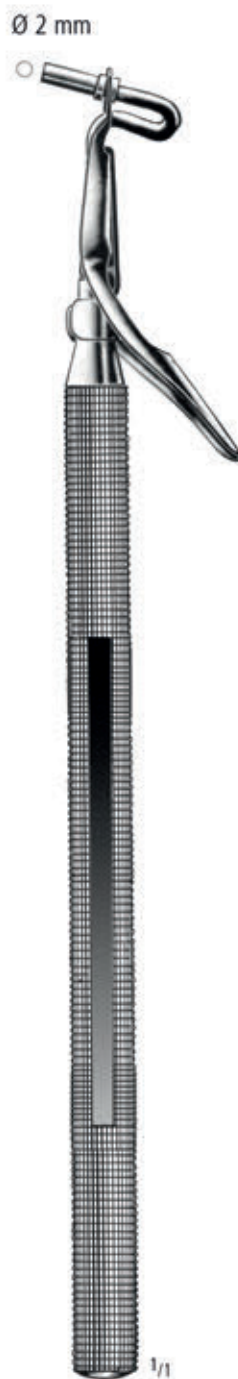

IVORY
PS 182/01
17,0 cm/6³/₄"

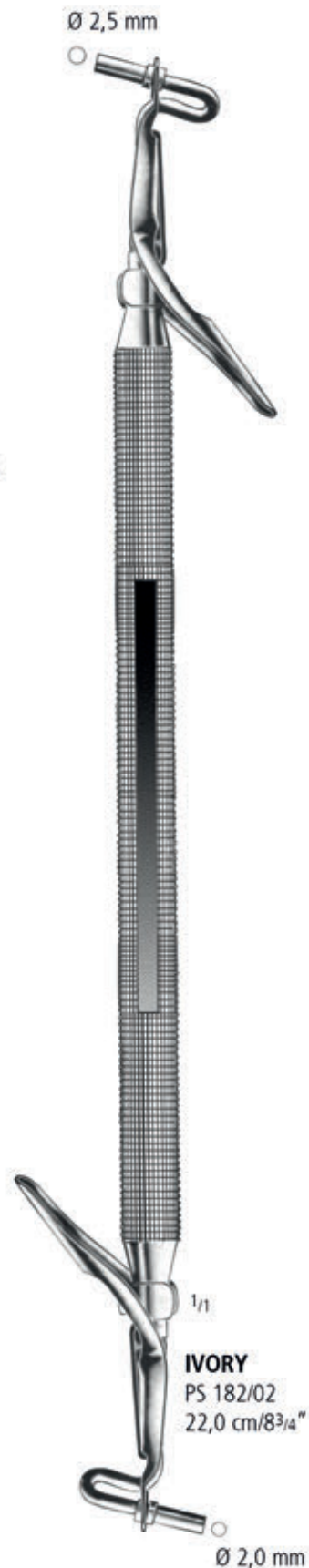

IVORY
PS 182/02
22,0 cm/8³/₄"

AA
AB
AC
AD
AE
AF
AK
AL
AO
AR
KA
KL
KU
PA
PB
PF
PI
PK
PL
PM
PP
PS
PT
PU
PV
KYE

Zementspatel
 Cement mixing spatula
 Espátula para mezclar
 Spatule à plâtre
 Spatola per cemento



18,0 cm/7"

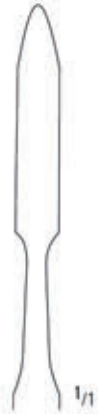

Fig. 1
PS 300/01



Fig. 2
PS 300/02



Fig. 3
PS 300/03



Zementspatel
 Cement mixing spatula
 Espátula para mezclar
 Spatule à plâtre
 Spatola per cemento



PS 302/18
 19,0 cm/7 1/2"



21,0 cm/8 1/4"



Fig. 00
 PS 303/01



Fig. 0
 PS 303/02



PS 304/02
 19,0 cm/7 1/2"



Fig. 2

AA
 AB
 AC
 AD
 AE
 AF
 AG
 AH
 AI
 AJ
 AK
 AL
 AM
 AN
 AO
 AP
 AQ
 AR
 AS
 AT
 AU
 AV
 AW
 AX
 AY
 AZ
 BA
 BB
 BC
 BD
 BE
 BF
 BG
 BH
 BI
 BJ
 BK
 BL
 BM
 BN
 BO
 BP
 BQ
 BR
 BS
 BT
 BU
 BV
 BW
 BX
 BY
 BZ
 CA
 CB
 CC
 CD
 CE
 CF
 CG
 CH
 CI
 CJ
 CK
 CL
 CM
 CN
 CO
 CP
 CQ
 CR
 CS
 CT
 CU
 CV
 CW
 CX
 CY
 CZ
 DA
 DB
 DC
 DD
 DE
 DF
 DG
 DH
 DI
 DJ
 DK
 DL
 DM
 DN
 DO
 DP
 DQ
 DR
 DS
 DT
 DU
 DV
 DW
 DX
 DY
 DZ
 EA
 EB
 EC
 ED
 EE
 EF
 EG
 EH
 EI
 EJ
 EK
 EL
 EM
 EN
 EO
 EP
 EQ
 ER
 ES
 ET
 EU
 EV
 EW
 EX
 EY
 EZ
 FA
 FB
 FC
 FD
 FE
 FF
 FG
 FH
 FI
 FJ
 FK
 FL
 FM
 FN
 FO
 FP
 FQ
 FR
 FS
 FT
 FU
 FV
 FW
 FX
 FY
 FZ
 GA
 GB
 GC
 GD
 GE
 GF
 GG
 GH
 GI
 GJ
 GK
 GL
 GM
 GN
 GO
 GP
 GQ
 GR
 GS
 GT
 GU
 GV
 GW
 GX
 GY
 GZ
 HA
 HB
 HC
 HD
 HE
 HF
 HG
 HH
 HI
 HJ
 HK
 HL
 HM
 HN
 HO
 HP
 HQ
 HR
 HS
 HT
 HU
 HV
 HW
 HX
 HY
 HZ
 IA
 IB
 IC
 ID
 IE
 IF
 IG
 IH
 II
 IJ
 IK
 IL
 IM
 IN
 IO
 IP
 IQ
 IR
 IS
 IT
 IU
 IV
 IW
 IX
 IY
 IZ
 JA
 JB
 JC
 JD
 JE
 JF
 JG
 JH
 JI
 JJ
 JK
 JL
 JM
 JN
 JO
 JP
 JQ
 JR
 JS
 JT
 JU
 JV
 JW
 JX
 JY
 JZ
 KA
 KB
 KC
 KD
 KE
 KF
 KG
 KH
 KI
 KJ
 KK
 KL
 KM
 KN
 KO
 KP
 KQ
 KR
 KS
 KT
 KU
 KV
 KW
 KX
 KY
 KZ
 LA
 LB
 LC
 LD
 LE
 LF
 LG
 LH
 LI
 LJ
 LK
 LL
 LM
 LN
 LO
 LP
 LQ
 LR
 LS
 LT
 LU
 LV
 LW
 LX
 LY
 LZ
 MA
 MB
 MC
 MD
 ME
 MF
 MG
 MH
 MI
 MJ
 MK
 ML
 MM
 MN
 MO
 MP
 MQ
 MR
 MS
 MT
 MU
 MV
 MW
 MX
 MY
 MZ
 NA
 NB
 NC
 ND
 NE
 NF
 NG
 NH
 NI
 NJ
 NK
 NL
 NM
 NN
 NO
 NP
 NQ
 NR
 NS
 NT
 NU
 NV
 NW
 NX
 NY
 NZ
 OA
 OB
 OC
 OD
 OE
 OF
 OG
 OH
 OI
 OJ
 OK
 OL
 OM
 ON
 OO
 OP
 OQ
 OR
 OS
 OT
 OU
 OV
 OW
 OX
 OY
 OZ
 PA
 PB
 PC
 PD
 PE
 PF
 PG
 PH
 PI
 PJ
 PK
 PL
 PM
 PN
 PO
 PP
 PQ
 PR
 PS
 PT
 PU
 PV
 PW
 PX
 PY
 PZ
 QA
 QB
 QC
 QD
 QE
 QF
 QG
 QH
 QI
 QJ
 QK
 QL
 QM
 QN
 QO
 QP
 QQ
 QR
 QS
 QT
 QU
 QV
 QW
 QX
 QY
 QZ
 RA
 RB
 RC
 RD
 RE
 RF
 RG
 RH
 RI
 RJ
 RK
 RL
 RM
 RN
 RO
 RP
 RQ
 RR
 RS
 RT
 RU
 RV
 RW
 RX
 RY
 RZ
 SA
 SB
 SC
 SD
 SE
 SF
 SG
 SH
 SI
 SJ
 SK
 SL
 SM
 SN
 SO
 SP
 SQ
 SR
 SS
 ST
 SU
 SV
 SW
 SX
 SY
 SZ
 TA
 TB
 TC
 TD
 TE
 TF
 TG
 TH
 TI
 TJ
 TK
 TL
 TM
 TN
 TO
 TP
 TQ
 TR
 TS
 TT
 TU
 TV
 TW
 TX
 TY
 TZ
 UA
 UB
 UC
 UD
 UE
 UF
 UG
 UH
 UI
 UJ
 UK
 UL
 UM
 UN
 UO
 UP
 UQ
 UR
 US
 UT
 UY
 UZ
 VA
 VB
 VC
 VD
 VE
 VF
 VG
 VH
 VI
 VJ
 VK
 VL
 VM
 VN
 VO
 VP
 VQ
 VR
 VS
 VT
 VY
 VZ
 WA
 WB
 WC
 WD
 WE
 WF
 WG
 WH
 WI
 WJ
 WK
 WL
 WM
 WN
 WO
 WP
 WQ
 WR
 WS
 WT
 WY
 WZ
 XA
 XB
 XC
 XD
 XE
 XF
 XG
 XH
 XI
 XJ
 XK
 XL
 XM
 XN
 XO
 XP
 XQ
 XR
 XS
 XT
 XU
 XV
 XW
 XX
 XY
 XZ
 YA
 YB
 YC
 YD
 YE
 YF
 YG
 YH
 YI
 YJ
 YK
 YL
 YM
 YN
 YO
 YP
 YQ
 YR
 YS
 YT
 YZ
 ZA
 ZB
 ZC
 ZD
 ZE
 ZF
 ZG
 ZH
 ZI
 ZJ
 ZK
 ZL
 ZM
 ZN
 ZO
 ZP
 ZQ
 ZR
 ZS
 ZT
 ZY
 ZZ

Kompositinstrumente
 Composite instruments
 Instrumentos para composites
 Instruments pour composites
 Strumenti composito



17,5 cm/7"



FELT
 Fig. 1
 PS 306/01



FELT
 Fig. 2
 PS 306/02



FELT
 Fig. 3
 PS 306/03



FELT
 Fig. 4
 PS 306/04



FELT
 Fig. 5
 PS 306/05



FELT
 Fig. 6
 PS 306/06



GOLDSTEIN
 Fig. 1
 PS 307/01



GOLDSTEIN
 Fig. 2
 PS 307/02



GOLDSTEIN
 Fig. 3
 PS 307/03



GOLDSTEIN
 Fig. 4
 PS 307/04



PROTHETIK UND ORTHODONTIE
PROTHETICS AND ORTHODONTIA
PROTESIS Y ORTODONCIA
PROTHESE ET ORTHODONTIE
PROTESI E ORTODONZIA

PT

nopa[®] instruments



Wachs-, Porzellan- und Modellierinstrumente
 Wax, porcelain and modelling carvers
 Talladores y espátulas para cera, porcelana y modelar
 Instruments à modeler
 Strumenti per modellare



Fig. 1S



WARD
PT 010/01



Fig. 2



WARD
PT 010/02



Fig. 2/3



FRAHM
PT 020/01



Fig. 1/2



HOLLENBACK
PT 050/01



Fig. 2



HOLLENBACK
PT 050/03

AA
AB
AC
AD
AE
AF
AK
AL
AO
AR
KA
KL
KU
PA
PB
PF
PI
PK
PL
PM
PP
PS
PT
PU
PV
KYE

Wachs-, Porzellan- und Modellierinstrumente
 Wax, porcelain and modelling carvers
 Talladores y espátulas para cera, porcelana y modelar
 Instruments à modeler
 Strumenti per modellare



HYLIN



HYLIN
 PT 080/00
 17,0 cm/6³/₄"



ZAHLE
 PT 090/00
 15,0 cm/6"



LE CRON Fig. 1
 PT 100/00
 16,0 cm/6¹/₄"



BEALE Fig. 1
 PT 120/00
 16,0 cm/6¹/₄"



Wachs-, Porzellan- und Modellierinstrumente
 Wax, porcelain and modelling carvers
 Talladores y espátulas para cera, porcelana y modelar
 Instruments à modeler
 Strumenti per modellare



THOMAS
 17,5 cm/7"



Fig. 1
 PT 130/01

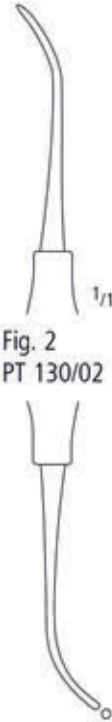

Fig. 2
 PT 130/02

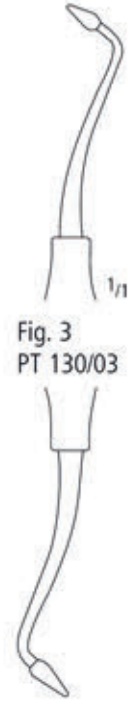

Fig. 3
 PT 130/03

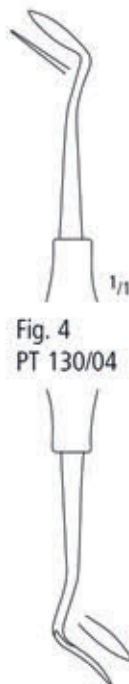

Fig. 4
 PT 130/04

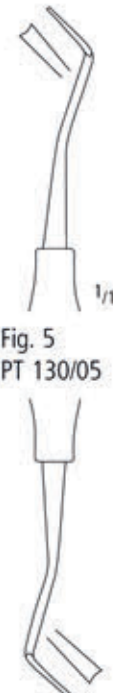

Fig. 5
 PT 130/05

AA
 AB
 AC
 AD
 AE
 AF
 AG
 AH
 AI
 AJ
 AK
 AL
 AM
 AN
 AO
 AP
 AQ
 AR
 AS
 AT
 AU
 AV
 AW
 AX
 AY
 AZ
 BA
 BB
 BC
 BD
 BE
 BF
 BG
 BH
 BI
 BJ
 BK
 BL
 BM
 BN
 BO
 BP
 BQ
 BR
 BS
 BT
 BU
 BV
 BW
 BX
 BY
 BZ
 CA
 CB
 CC
 CD
 CE
 CF
 CG
 CH
 CI
 CJ
 CK
 CL
 CM
 CN
 CO
 CP
 CQ
 CR
 CS
 CT
 CU
 CV
 CW
 CX
 CY
 CZ
 DA
 DB
 DC
 DD
 DE
 DF
 DG
 DH
 DI
 DJ
 DK
 DL
 DM
 DN
 DO
 DP
 DQ
 DR
 DS
 DT
 DU
 DV
 DW
 DX
 DY
 DZ
 EA
 EB
 EC
 ED
 EE
 EF
 EG
 EH
 EI
 EJ
 EK
 EL
 EM
 EN
 EO
 EP
 EQ
 ER
 ES
 ET
 EU
 EV
 EW
 EX
 EY
 EZ
 FA
 FB
 FC
 FD
 FE
 FF
 FG
 FH
 FI
 FJ
 FK
 FL
 FM
 FN
 FO
 FP
 FQ
 FR
 FS
 FT
 FU
 FV
 FW
 FX
 FY
 FZ
 GA
 GB
 GC
 GD
 GE
 GF
 GG
 GH
 GI
 GJ
 GK
 GL
 GM
 GN
 GO
 GP
 GQ
 GR
 GS
 GT
 GU
 GV
 GW
 GX
 GY
 GZ
 HA
 HB
 HC
 HD
 HE
 HF
 HG
 HH
 HI
 HJ
 HK
 HL
 HM
 HN
 HO
 HP
 HQ
 HR
 HS
 HT
 HU
 HV
 HW
 HX
 HY
 HZ
 IA
 IB
 IC
 ID
 IE
 IF
 IG
 IH
 II
 IJ
 IK
 IL
 IM
 IN
 IO
 IP
 IQ
 IR
 IS
 IT
 IU
 IV
 IW
 IX
 IY
 IZ
 JA
 JB
 JC
 JD
 JE
 JF
 JG
 JH
 JI
 JJ
 JK
 JL
 JM
 JN
 JO
 JP
 JQ
 JR
 JS
 JT
 JU
 JV
 JW
 JX
 JY
 JZ
 KA
 KB
 KC
 KD
 KE
 KF
 KG
 KH
 KI
 KJ
 KK
 KL
 KM
 KN
 KO
 KP
 KQ
 KR
 KS
 KT
 KU
 KV
 KW
 KX
 KY
 KZ
 LA
 LB
 LC
 LD
 LE
 LF
 LG
 LH
 LI
 LJ
 LK
 LL
 LM
 LN
 LO
 LP
 LQ
 LR
 LS
 LT
 LU
 LV
 LW
 LX
 LY
 LZ
 MA
 MB
 MC
 MD
 ME
 MF
 MG
 MH
 MI
 MJ
 MK
 ML
 MM
 MN
 MO
 MP
 MQ
 MR
 MS
 MT
 MU
 MV
 MW
 MX
 MY
 MZ
 NA
 NB
 NC
 ND
 NE
 NF
 NG
 NH
 NI
 NJ
 NK
 NL
 NM
 NN
 NO
 NP
 NQ
 NR
 NS
 NT
 NU
 NV
 NW
 NX
 NY
 NZ
 OA
 OB
 OC
 OD
 OE
 OF
 OG
 OH
 OI
 OJ
 OK
 OL
 OM
 ON
 OO
 OP
 OQ
 OR
 OS
 OT
 OU
 OV
 OW
 OX
 OY
 OZ
 PA
 PB
 PC
 PD
 PE
 PF
 PG
 PH
 PI
 PJ
 PK
 PL
 PM
 PN
 PO
 PP
 PQ
 PR
 PS
 PT
 PU
 PV
 PW
 PX
 PY
 PZ
 QA
 QB
 QC
 QD
 QE
 QF
 QG
 QH
 QI
 QJ
 QK
 QL
 QM
 QN
 QO
 QP
 QQ
 QR
 QS
 QT
 QU
 QV
 QW
 QX
 QY
 QZ
 RA
 RB
 RC
 RD
 RE
 RF
 RG
 RH
 RI
 RJ
 RK
 RL
 RM
 RN
 RO
 RP
 RQ
 RR
 RS
 RT
 RU
 RV
 RW
 RX
 RY
 RZ
 SA
 SB
 SC
 SD
 SE
 SF
 SG
 SH
 SI
 SJ
 SK
 SL
 SM
 SN
 SO
 SP
 SQ
 SR
 SS
 ST
 SU
 SV
 SW
 SX
 SY
 SZ
 TA
 TB
 TC
 TD
 TE
 TF
 TG
 TH
 TI
 TJ
 TK
 TL
 TM
 TN
 TO
 TP
 TQ
 TR
 TS
 TT
 TU
 TV
 TW
 TX
 TY
 TZ
 UA
 UB
 UC
 UD
 UE
 UF
 UG
 UH
 UI
 UJ
 UK
 UL
 UM
 UN
 UO
 UP
 UQ
 UR
 US
 UT
 UY
 UZ
 VA
 VB
 VC
 VD
 VE
 VF
 VG
 VH
 VI
 VJ
 VK
 VL
 VM
 VN
 VO
 VP
 VQ
 VR
 VS
 VT
 VU
 VV
 VW
 VX
 VY
 VZ
 WA
 WB
 WC
 WD
 WE
 WF
 WG
 WH
 WI
 WJ
 WK
 WL
 WM
 WN
 WO
 WP
 WQ
 WR
 WS
 WT
 WU
 WV
 WW
 WX
 WY
 WZ
 XA
 XB
 XC
 XD
 XE
 XF
 XG
 XH
 XI
 XJ
 XK
 XL
 XM
 XN
 XO
 XP
 XQ
 XR
 XS
 XT
 XU
 XV
 XW
 XX
 XY
 XZ
 YA
 YB
 YC
 YD
 YE
 YF
 YG
 YH
 YI
 YJ
 YK
 YL
 YM
 YN
 YO
 YP
 YQ
 YR
 YS
 YT
 YU
 YV
 YW
 YX
 YZ
 ZA
 ZB
 ZC
 ZD
 ZE
 ZF
 ZG
 ZH
 ZI
 ZJ
 ZK
 ZL
 ZM
 ZN
 ZO
 ZP
 ZQ
 ZR
 ZS
 ZT
 ZU
 ZV
 ZW
 ZX
 ZY
 ZZ

Wachs-, Porzellan- und Modellierinstrumente
 Wax, porcelain and modelling carvers
 Talladores y espátulas para cera, porcelana y modelar
 Instruments à modeler
 Strumenti per modellare



PT 200/13
 13,0 cm/5"

PT 200/17
 17,0 cm/6³/₄"

FAHNENSTOCK



GRITMANN
 PT 205/17
 17,0 cm/6³/₄"



LICHTENSTEIN
 PT 208/17
 17,0 cm/6³/₄"

Kroneninstrumente
 Instruments for crown work
 Instrumentos para coronas
 Instruments de couronnes
 Strumenti per corone



MERSHON
 PT 220/00
 14,5 cm/5³/₄"



PT 230/00
 14,0 cm/5¹/₂"



TREYMAN
 PT 240/00
 16,0 cm/6¹/₄"

AA
 AB
 AC
 AD
 AE
 AF
 AG
 AH
 AI
 AJ
 AK
 AL
 AO
 AP
 AQ
 AR
 AS
 AT
 AU
 AV
 AW
 AX
 AY
 AZ
 BA
 BB
 BC
 BD
 BE
 BF
 BG
 BH
 BI
 BJ
 BK
 BL
 BM
 BN
 BO
 BP
 BQ
 BR
 BS
 BT
 BU
 BV
 BW
 BX
 BY
 BZ
 CA
 CB
 CC
 CD
 CE
 CF
 CG
 CH
 CI
 CJ
 CK
 CL
 CM
 CN
 CO
 CP
 CQ
 CR
 CS
 CT
 CU
 CV
 CW
 CX
 CY
 CZ
 DA
 DB
 DC
 DD
 DE
 DF
 DG
 DH
 DI
 DJ
 DK
 DL
 DM
 DN
 DO
 DP
 DQ
 DR
 DS
 DT
 DU
 DV
 DW
 DX
 DY
 DZ
 EA
 EB
 EC
 ED
 EE
 EF
 EG
 EH
 EI
 EJ
 EK
 EL
 EM
 EN
 EO
 EP
 EQ
 ER
 ES
 ET
 EU
 EV
 EW
 EX
 EY
 EZ
 FA
 FB
 FC
 FD
 FE
 FF
 FG
 FH
 FI
 FJ
 FK
 FL
 FM
 FN
 FO
 FP
 FQ
 FR
 FS
 FT
 FU
 FV
 FW
 FX
 FY
 FZ
 GA
 GB
 GC
 GD
 GE
 GF
 GG
 GH
 GI
 GJ
 GK
 GL
 GM
 GN
 GO
 GP
 GQ
 GR
 GS
 GT
 GU
 GV
 GW
 GX
 GY
 GZ
 HA
 HB
 HC
 HD
 HE
 HF
 HG
 HH
 HI
 HJ
 HK
 HL
 HM
 HN
 HO
 HP
 HQ
 HR
 HS
 HT
 HU
 HV
 HW
 HX
 HY
 HZ
 IA
 IB
 IC
 ID
 IE
 IF
 IG
 IH
 II
 IJ
 IK
 IL
 IM
 IN
 IO
 IP
 IQ
 IR
 IS
 IT
 IU
 IV
 IW
 IX
 IY
 IZ
 JA
 JB
 JC
 JD
 JE
 JF
 JG
 JH
 JI
 JJ
 JK
 JL
 JM
 JN
 JO
 JP
 JQ
 JR
 JS
 JT
 JU
 JV
 JW
 JX
 JY
 JZ
 KA
 KB
 KC
 KD
 KE
 KF
 KG
 KH
 KI
 KJ
 KK
 KL
 KM
 KN
 KO
 KP
 KQ
 KR
 KS
 KT
 KU
 KV
 KW
 KX
 KY
 KZ
 LA
 LB
 LC
 LD
 LE
 LF
 LG
 LH
 LI
 LJ
 LK
 LL
 LM
 LN
 LO
 LP
 LQ
 LR
 LS
 LT
 LU
 LV
 LW
 LX
 LY
 LZ
 MA
 MB
 MC
 MD
 ME
 MF
 MG
 MH
 MI
 MJ
 MK
 ML
 MM
 MN
 MO
 MP
 MQ
 MR
 MS
 MT
 MU
 MV
 MW
 MX
 MY
 MZ
 NA
 NB
 NC
 ND
 NE
 NF
 NG
 NH
 NI
 NJ
 NK
 NL
 NM
 NN
 NO
 NP
 NQ
 NR
 NS
 NT
 NU
 NV
 NW
 NX
 NY
 NZ
 OA
 OB
 OC
 OD
 OE
 OF
 OG
 OH
 OI
 OJ
 OK
 OL
 OM
 ON
 OO
 OP
 OQ
 OR
 OS
 OT
 OU
 OV
 OW
 OX
 OY
 OZ
 PA
 PB
 PC
 PD
 PE
 PF
 PG
 PH
 PI
 PJ
 PK
 PL
 PM
 PN
 PO
 PP
 PQ
 PR
 PS
 PT
 PU
 PV
 PW
 PX
 PY
 PZ
 QA
 QB
 QC
 QD
 QE
 QF
 QG
 QH
 QI
 QJ
 QK
 QL
 QM
 QN
 QO
 QP
 QQ
 QR
 QS
 QT
 QU
 QV
 QW
 QX
 QY
 QZ
 RA
 RB
 RC
 RD
 RE
 RF
 RG
 RH
 RI
 RJ
 RK
 RL
 RM
 RN
 RO
 RP
 RQ
 RR
 RS
 RT
 RU
 RV
 RW
 RX
 RY
 RZ
 SA
 SB
 SC
 SD
 SE
 SF
 SG
 SH
 SI
 SJ
 SK
 SL
 SM
 SN
 SO
 SP
 SQ
 SR
 SS
 ST
 SU
 SV
 SW
 SX
 SY
 SZ
 TA
 TB
 TC
 TD
 TE
 TF
 TG
 TH
 TI
 TJ
 TK
 TL
 TM
 TN
 TO
 TP
 TQ
 TR
 TS
 TU
 TV
 TW
 TX
 TY
 TZ
 UA
 UB
 UC
 UD
 UE
 UF
 UG
 UH
 UI
 UJ
 UK
 UL
 UM
 UN
 UO
 UP
 UQ
 UR
 US
 UT
 UU
 UV
 UW
 UX
 UY
 UZ
 VA
 VB
 VC
 VD
 VE
 VF
 VG
 VH
 VI
 VJ
 VK
 VL
 VM
 VN
 VO
 VP
 VQ
 VR
 VS
 VT
 VU
 VV
 VW
 VX
 VY
 VZ
 WA
 WB
 WC
 WD
 WE
 WF
 WG
 WH
 WI
 WJ
 WK
 WL
 WM
 WN
 WO
 WP
 WQ
 WR
 WS
 WT
 WU
 WV
 WW
 WX
 WY
 WZ
 XA
 XB
 XC
 XD
 XE
 XF
 XG
 XH
 XI
 XJ
 XK
 XL
 XM
 XN
 XO
 XP
 XQ
 XR
 XS
 XT
 XU
 XV
 XW
 XX
 XY
 XZ
 YA
 YB
 YC
 YD
 YE
 YF
 YG
 YH
 YI
 YJ
 YK
 YL
 YM
 YN
 YO
 YP
 YQ
 YR
 YS
 YT
 YU
 YV
 YW
 YX
 YZ
 ZA
 ZB
 ZC
 ZD
 ZE
 ZF
 ZG
 ZH
 ZI
 ZJ
 ZK
 ZL
 ZM
 ZN
 ZO
 ZP
 ZQ
 ZR
 ZS
 ZT
 ZU
 ZV
 ZW
 ZX
 ZY
 ZZ

Kroneninstrumente
 Instruments for crown work
 Instrumentos para coronas
 Instruments de couronnes
 Strumenti per corone



CROWN-REMOVER
 PT 250/00
 15,0 cm/6"



Fig. 1
 PT 250/01



Fig. 2
 PT 250/02



Fig. 3
 PT 250/03



WYMAN
 PT 255/16
 16,0 cm/6¹/₄"

Drahtzangen
Wire Forceps
Pinzas para hilos
Pincers à fil
Tenaglie fili



KA 250/00
15,0 cm/6"



KA 250/14
14,0 cm/5 1/2"



KA 251/14
14,0 cm/5 1/2"



KA 252/16
16,0 cm/6 1/4"



KA 253/19
19,0 cm/7 1/2"



KA 257/15
15,0 cm/6"

AA
AB
AC
AD
AE
AF
AK
AL
AO
AR
KA
KL
KU
PA
PB
PF
PI
PK
PL
PM
PP
PS
PT
PU
PV
KYE

Drahtzangen
Wire Forceps
Pinzas para hilos
Pincas à fil
Tenaglie fili

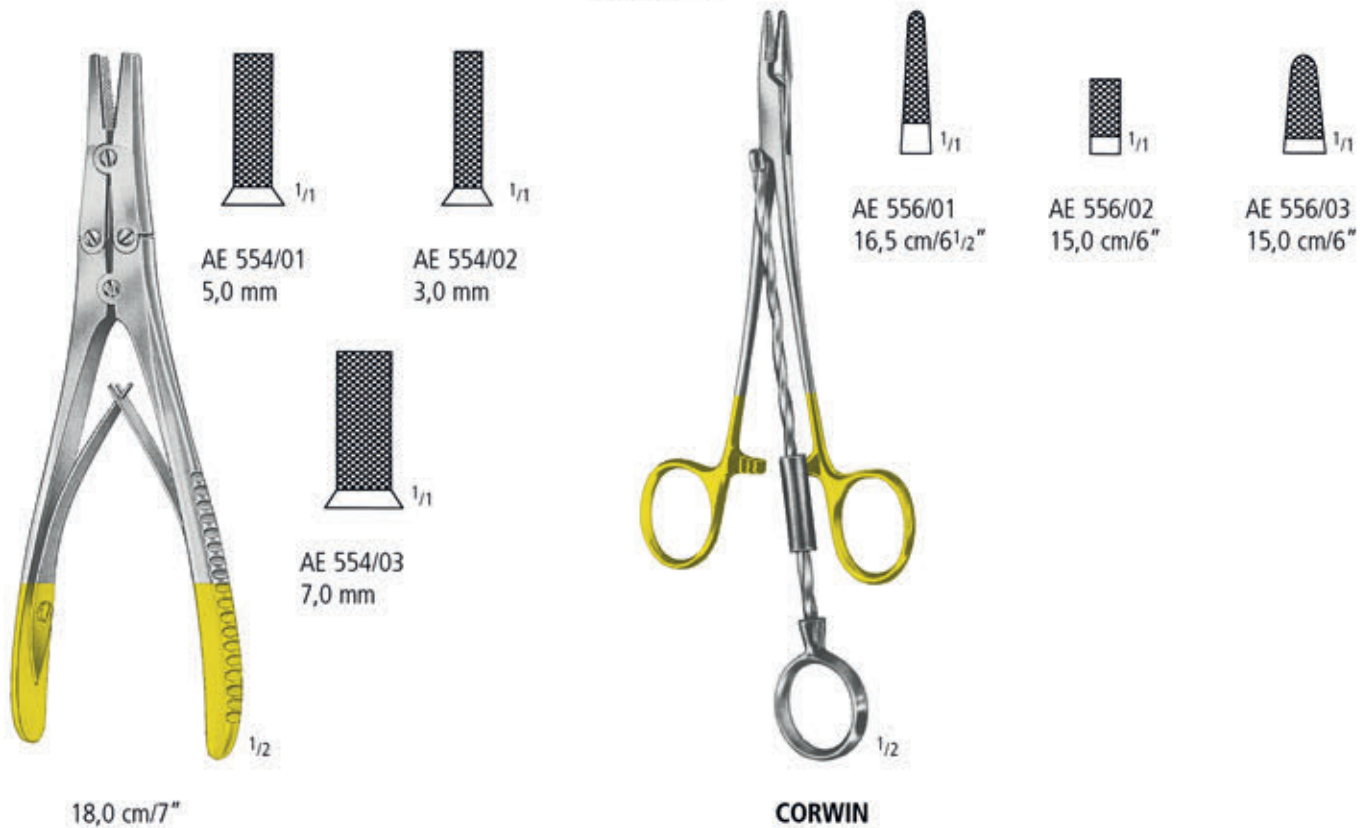

Flachzangen und Drahtzangen
 Flat Nose Pliers and Wire Forceps
 Alicates planos y pinzas para hilos
 Pincers plates et pincers à fil
 Tenaglie piatte e tenaglie fili



KA 265/18
 18,0 cm/7"

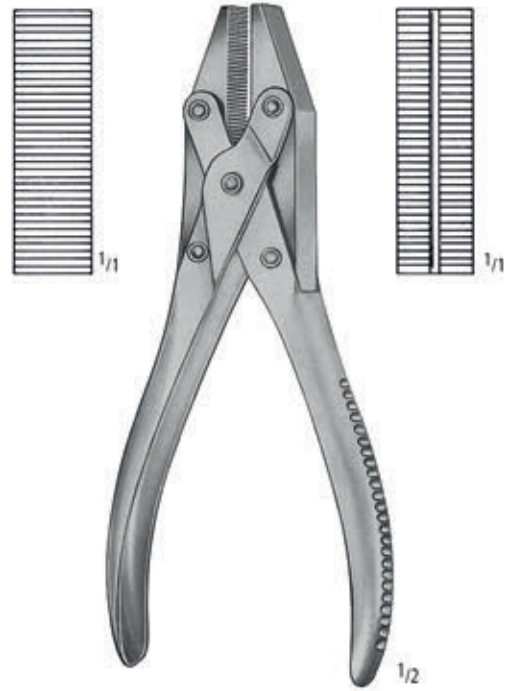

KA 266/17
 17,0 cm/6³/₄"



KA 270/15
 15,0 cm/6"



KA 271/16
 16 cm/6¹/₄"

- >> Draht- und Kronenscheren finden Sie in der Gruppe AC.
- >> For wire cutting and crown scissors, kindly see Instrument group AC.
- >> Para cizallas cortar alambres y tijeras para coronas por favor se encuentra en el grupo de Instrumentos AC.
- >> Pour des cisailles à fils et des ciseaux à couronnes, consultez la section des instruments AC.
- >> Per forbici per filo metallico e per corone consultare il gruppo strumenti AC.

AA
AB
AC
AD
AE
AF
AK
AL
AO
AR
KA
KL
KU
PA
PB
PF
PI
PK
PL
PM
PP
PS
PT
PU
PV
KYE

Drahtzangen
Wire Forceps
Pinzas para hilos
Pinces à fil
Tenaglie fili



für weiche Drähte bis 2,0 mm Ø
for soft wires up to 2,0 mm Ø
para hilos blandos hasta 2,0 mm de Ø
pour fils mous jusqu'à 2,0 mm de Ø
per fili morbidi sino a mm 2,0 di Ø

für harte Drähte bis 1,5 mm Ø
for hard wires up to 1,5 mm Ø
para hilos duros hasta 1,5 mm de Ø
pour fils durs jusqu'à 1,5 mm de Ø
per fili duri sino a mm 1,5 di Ø

KA 272/18
18,0 cm/7"



für weiche Drähte bis 2,0 mm Ø
for soft wires up to 2,0 mm Ø
para hilos blandos hasta 2,0 mm de Ø
pour fils mous jusqu'à 2,0 mm de Ø
per fili morbidi sino a mm 2,0 di Ø

für harte Drähte bis 1,6 mm Ø
for hard wires up to 1,6 mm Ø
para hilos duros hasta 1,6 mm de Ø
pour fils durs jusqu'à 1,6 mm de Ø
per fili duri sino a mm 1,6 di Ø

KA 273/17
17,0 cm/6³/₄"

nopa
TUG[®]



für Drähte bis 2,5 mm Ø
for wires up to 2,5 mm Ø
para hilos hasta 2,5 mm de Ø
pour fils jusqu'à 2,5 mm de Ø
per fili sino a mm 2,5 di Ø

KA 273/22
22,0 cm/8³/₄"

- >> Draht- und Kronenscheren finden Sie in der Gruppe AC.
- >> For wire cutting and crown scissors, kindly see Instrument group AC.
- >> Para cizallas cortar alamoses y tijeras para coronas por favor se encuentra en el grupo de Instrumentos AC.
- >> Pour des cisailles à fils et des ciseaux à couronnes, consultez la section des instruments AC.
- >> Per forbici per filo metallico e per corone consultare il gruppo strumenti AC.

Bügelbiegezangen
 Bar Bending Pliers
 Alicates para doblar alambres
 Pincès à courber les branches
 Tenaglie per la piegatura di staffe



SCHWARZ
 13,0 cm/5"



Fig. 1
 PT 300/01



Fig. 2
 PT 300/02



Fig. 3
 PT 300/03

AA
 AB
 AC
 AD
 AE
 AF
 AK
 AL
 AO
 AR
 KA
 KL
 KU
 PA
 PB
 PF
 PI
 PK
 PL
 PM
 PP
 PS
PT
 PU
 PV
 KYE

Zwickzangen, Bügelbiegezangen
 End and side nippers, bar bending pliers
 Alicates cortantes y alicates para doblar alambres
 Pincers, pincers à courber les branches
 Tenaglie, tenaglie per la piegatura di staffe



PT 308/12
 12,5 cm/5"



PT 309/11
 11,0 cm/4 1/3"

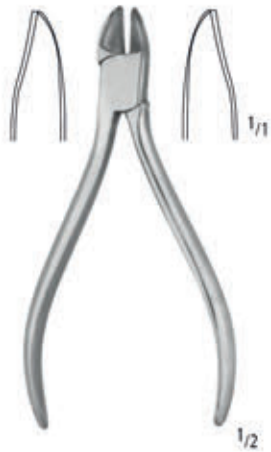

PT 310/11
 11,0 cm/4 1/3"

PT 310/15
 15,0 cm/6"



PT 315/00
 11,0 cm/4 1/3"

Universalzangen
 Universal Pliers
 Alicates universales
 Pincers universelles
 Tenaglie universali

AA
 AB
 AC
 AD
 AE
 AF
 AK
 AL
 AO
 AR
 KA
 KL
 KU
 PA
 PB
 PF
 PI
 PK
 PL
 PM
 PP
 PS
PT
 PU
 PV
 KYE



UNIVERSAL
 PT 316/15
 15,0 cm/6"



WALDSACHS
 PT 316/16
 16,0 cm/6¹/₄"

Ligaturzangen
 Ligature Pliers
 Alicates para ligatura
 Pincers à ligature
 Tenaglie per legatura

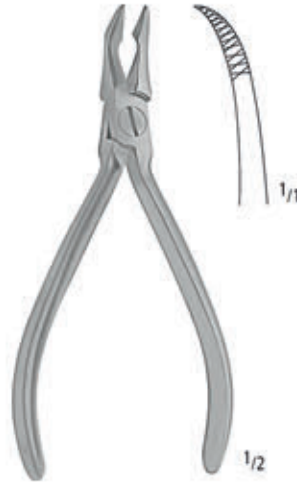

WEINGART
 PT 319/12
 12,5 cm/5"



HOW
 14,0 cm/5 1/2"



HOW
 PT 320/14
 14,0 cm/5 1/2"



HOW
 PT 322/14
 14,0 cm/5 1/2"



HOW
 PT 321/14
 14,0 cm/5 1/2"



HOW
 PT 323/14
 14,0 cm/5 1/2"

Distalschneider, Drahtbiegezange
 Distal cutter, wire bending pliers
 Alicates para cortar alambres, alicates para doblar alambres
 Pince coupeur distale, pince pour technique
 Pinza per tagliare filo, pinza tecnica per filo con scanalatura

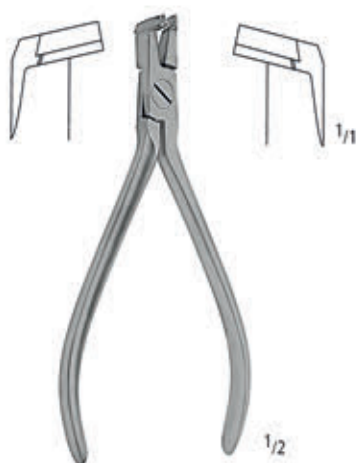

PT 324/12
 12,0 cm/4³/₄"



ANGLE
 PT 325/12
 12,0 cm/4³/₄"



ANGLE
 PT 326/12
 12,5 cm/5"



ADERER
 PT 327/15
 14,5 cm/5³/₄"



ADAMS
 PT 328/13
 12,5 cm/5"



NANCE
 PT 329/13
 12,5 cm/5"

AA
 AB
 AC
 AD
 AE
 AF
 AK
 AL
 AO
 AR
 KA
 KL
 KU
 PA
 PB
 PF
 PI
 PK
 PL
 PM
 PP
 PS
PT
 PU
 PV
 KYE

Klammerbiegezangen
Clasp Bending Pliers
Alicates para doblar ganchos
Pinces à courber agrafes
Tenaglie per la piegatura di graffe



ADERER
PT 330/14
14,0 cm/5¹/₂"



NANCE
PT 331/13
13,0 cm/5"



SCHWARZ
PT 333/14
14,0 cm/5¹/₂"

Drahtbiegezangen
 Wire Bending Pliers
 Alicates para doblar alambres
 Pincas à courber fils
 Tenaglie per la piegatura di fili metallici

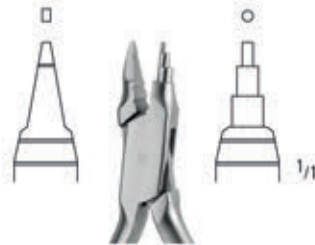

YOUNG
 PT 336/13
 13,0 cm/5"

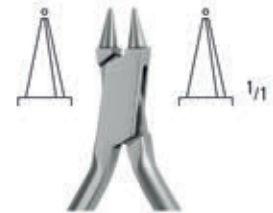

PT 337/12
 12,0 cm/4³/₄"



SCHWARZ
 PT 340/14
 14,0 cm/5¹/₂"

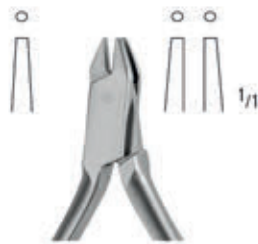

ADERER
 PT 338/12
 12,0 cm/4³/₄"

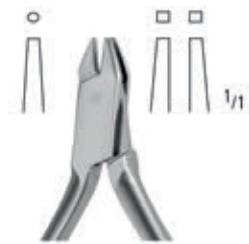

ADERER
 PT 339/12
 12,0 cm/4³/₄"

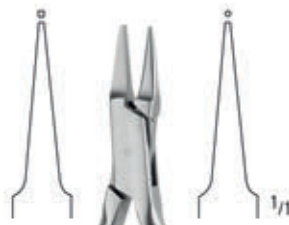

ADERER
 PT 341/13
 13,0 cm/5"



ANGLE
 PT 342/12
 12,0 cm/4³/₄"

AA
 AB
 AC
 AD
 AE
 AF
 AG
 AH
 AI
 AJ
 AK
 AL
 AO
 AP
 AQ
 AR
 AS
 AT
 AU
 AV
 AW
 AX
 AY
 AZ
 BA
 BB
 BC
 BD
 BE
 BF
 BG
 BH
 BI
 BJ
 BK
 BL
 BM
 BN
 BO
 BP
 BQ
 BR
 BS
 BT
 BU
 BV
 BW
 BX
 BY
 BZ
 CA
 CB
 CC
 CD
 CE
 CF
 CG
 CH
 CI
 CJ
 CK
 CL
 CM
 CN
 CO
 CP
 CQ
 CR
 CS
 CT
 CU
 CV
 CW
 CX
 CY
 CZ
 DA
 DB
 DC
 DD
 DE
 DF
 DG
 DH
 DI
 DJ
 DK
 DL
 DM
 DN
 DO
 DP
 DQ
 DR
 DS
 DT
 DU
 DV
 DW
 DX
 DY
 DZ
 EA
 EB
 EC
 ED
 EE
 EF
 EG
 EH
 EI
 EJ
 EK
 EL
 EM
 EN
 EO
 EP
 EQ
 ER
 ES
 ET
 EU
 EV
 EW
 EX
 EY
 EZ
 FA
 FB
 FC
 FD
 FE
 FF
 FG
 FH
 FI
 FJ
 FK
 FL
 FM
 FN
 FO
 FP
 FQ
 FR
 FS
 FT
 FU
 FV
 FW
 FX
 FY
 FZ
 GA
 GB
 GC
 GD
 GE
 GF
 GG
 GH
 GI
 GJ
 GK
 GL
 GM
 GN
 GO
 GP
 GQ
 GR
 GS
 GT
 GU
 GV
 GW
 GX
 GY
 GZ
 HA
 HB
 HC
 HD
 HE
 HF
 HG
 HH
 HI
 HJ
 HK
 HL
 HM
 HN
 HO
 HP
 HQ
 HR
 HS
 HT
 HU
 HV
 HW
 HX
 HY
 HZ
 IA
 IB
 IC
 ID
 IE
 IF
 IG
 IH
 II
 IJ
 IK
 IL
 IM
 IN
 IO
 IP
 IQ
 IR
 IS
 IT
 IU
 IV
 IW
 IX
 IY
 IZ
 JA
 JB
 JC
 JD
 JE
 JF
 JG
 JH
 JI
 JJ
 JK
 JL
 JM
 JN
 JO
 JP
 JQ
 JR
 JS
 JT
 JU
 JV
 JW
 JX
 JY
 JZ
 KA
 KB
 KC
 KD
 KE
 KF
 KG
 KH
 KI
 KJ
 KK
 KL
 KM
 KN
 KO
 KP
 KQ
 KR
 KS
 KT
 KU
 KV
 KW
 KX
 KY
 KZ
 LA
 LB
 LC
 LD
 LE
 LF
 LG
 LH
 LI
 LJ
 LK
 LL
 LM
 LN
 LO
 LP
 LQ
 LR
 LS
 LT
 LU
 LV
 LW
 LX
 LY
 LZ
 MA
 MB
 MC
 MD
 ME
 MF
 MG
 MH
 MI
 MJ
 MK
 ML
 MM
 MN
 MO
 MP
 MQ
 MR
 MS
 MT
 MU
 MV
 MW
 MX
 MY
 MZ
 NA
 NB
 NC
 ND
 NE
 NF
 NG
 NH
 NI
 NJ
 NK
 NL
 NM
 NN
 NO
 NP
 NQ
 NR
 NS
 NT
 NU
 NV
 NW
 NX
 NY
 NZ
 OA
 OB
 OC
 OD
 OE
 OF
 OG
 OH
 OI
 OJ
 OK
 OL
 OM
 ON
 OO
 OP
 OQ
 OR
 OS
 OT
 OU
 OV
 OW
 OX
 OY
 OZ
 PA
 PB
 PC
 PD
 PE
 PF
 PG
 PH
 PI
 PJ
 PK
 PL
 PM
 PN
 PO
 PP
 PQ
 PR
 PS
 PT
 PU
 PV
 PW
 PX
 PY
 PZ
 QA
 QB
 QC
 QD
 QE
 QF
 QG
 QH
 QI
 QJ
 QK
 QL
 QM
 QN
 QO
 QP
 QQ
 QR
 QS
 QT
 QU
 QV
 QW
 QX
 QY
 QZ
 RA
 RB
 RC
 RD
 RE
 RF
 RG
 RH
 RI
 RJ
 RK
 RL
 RM
 RN
 RO
 RP
 RQ
 RR
 RS
 RT
 RU
 RV
 RW
 RX
 RY
 RZ
 SA
 SB
 SC
 SD
 SE
 SF
 SG
 SH
 SI
 SJ
 SK
 SL
 SM
 SN
 SO
 SP
 SQ
 SR
 SS
 ST
 SU
 SV
 SW
 SX
 SY
 SZ
 TA
 TB
 TC
 TD
 TE
 TF
 TG
 TH
 TI
 TJ
 TK
 TL
 TM
 TN
 TO
 TP
 TQ
 TR
 TS
 TT
 TU
 TV
 TW
 TX
 TY
 TZ
 UA
 UB
 UC
 UD
 UE
 UF
 UG
 UH
 UI
 UJ
 UK
 UL
 UM
 UN
 UO
 UP
 UQ
 UR
 US
 UT
 UY
 UZ
 VA
 VB
 VC
 VD
 VE
 VF
 VG
 VH
 VI
 VJ
 VK
 VL
 VM
 VN
 VO
 VP
 VQ
 VR
 VS
 VT
 VU
 VV
 VW
 VX
 VY
 VZ
 WA
 WB
 WC
 WD
 WE
 WF
 WG
 WH
 WI
 WJ
 WK
 WL
 WM
 WN
 WO
 WP
 WQ
 WR
 WS
 WT
 WU
 WV
 WW
 WX
 WY
 WZ
 XA
 XB
 XC
 XD
 XE
 XF
 XG
 XH
 XI
 XJ
 XK
 XL
 XM
 XN
 XO
 XP
 XQ
 XR
 XS
 XT
 XU
 XV
 XW
 XX
 XY
 XZ
 YA
 YB
 YC
 YD
 YE
 YF
 YG
 YH
 YI
 YJ
 YK
 YL
 YM
 YN
 YO
 YP
 YQ
 YR
 YS
 YT
 YU
 YV
 YW
 YX
 YZ
 ZA
 ZB
 ZC
 ZD
 ZE
 ZF
 ZG
 ZH
 ZI
 ZJ
 ZK
 ZL
 ZM
 ZN
 ZO
 ZP
 ZQ
 ZR
 ZS
 ZT
 ZU
 ZV
 ZW
 ZX
 ZY
 ZZ

Rund-/Flachzangen
 Flat nose pliers
 Alicates de pico plano
 Pincers plates, rondes
 Tenaglie piatte

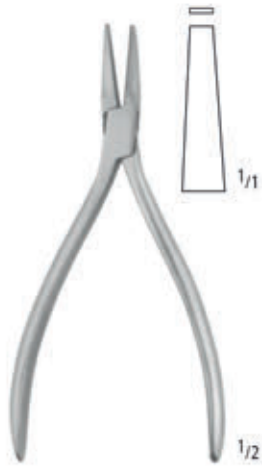

DUMONT
 PT 400/11
 11,5 cm/4¹/₂"

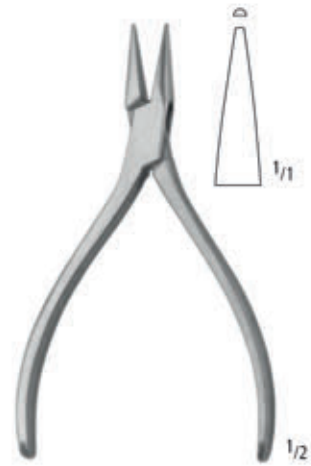

DUMONT
 PT 401/11
 11,5 cm/4¹/₂"

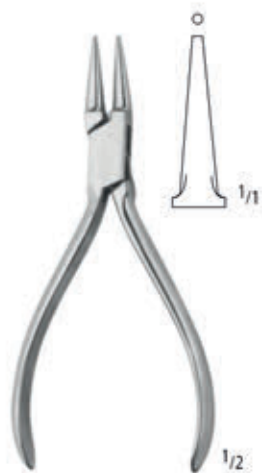

DUMONT
 PT 402/11
 11,5 cm/4¹/₂"



HOLLOW-CHOP
 PT 403/14
 14,0 cm/5¹/₂"

Rund-/Flachzangen
 Flat nose pliers
 Alicates de pico plano
 Pincers plates, rondes
 Tenaglie piatte

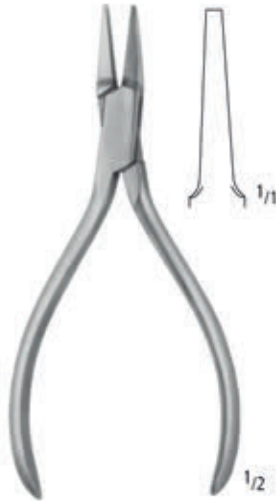

PT 411/13
 13,0 cm/5"

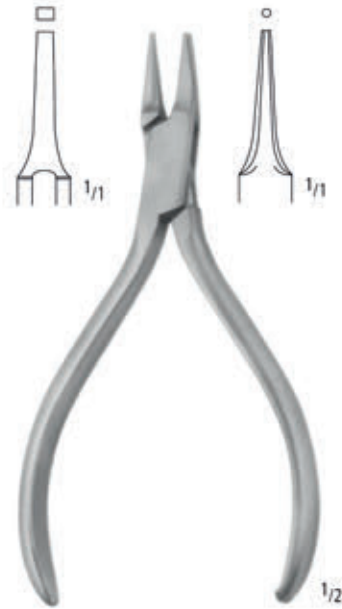

PT 415/15
 15,0 cm/6"

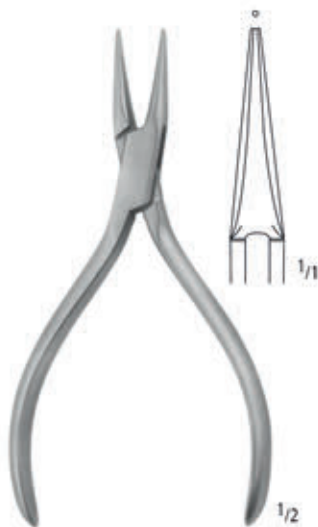

PT 420/13
 13,0 cm/5"

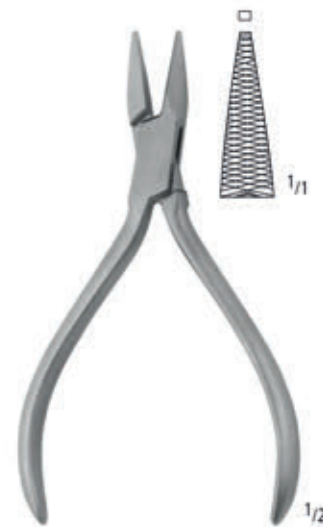

PT 440/13
 13,0 cm/5"

AA
 AB
 AC
 AD
 AE
 AF
 AG
 AH
 AI
 AJ
 AK
 AL
 AO
 AP
 AQ
 AR
 AS
 AT
 AU
 AV
 AW
 AX
 AY
 AZ
 BA
 BB
 BC
 BD
 BE
 BF
 BG
 BH
 BI
 BJ
 BK
 BL
 BM
 BN
 BO
 BP
 BQ
 BR
 BS
 BT
 BU
 BV
 BW
 BX
 BY
 BZ
 CA
 CB
 CC
 CD
 CE
 CF
 CG
 CH
 CI
 CJ
 CK
 CL
 CM
 CN
 CO
 CP
 CQ
 CR
 CS
 CT
 CU
 CV
 CW
 CX
 CY
 CZ
 DA
 DB
 DC
 DD
 DE
 DF
 DG
 DH
 DI
 DJ
 DK
 DL
 DM
 DN
 DO
 DP
 DQ
 DR
 DS
 DT
 DU
 DV
 DW
 DX
 DY
 DZ
 EA
 EB
 EC
 ED
 EE
 EF
 EG
 EH
 EI
 EJ
 EK
 EL
 EM
 EN
 EO
 EP
 EQ
 ER
 ES
 ET
 EU
 EV
 EW
 EX
 EY
 EZ
 FA
 FB
 FC
 FD
 FE
 FF
 FG
 FH
 FI
 FJ
 FK
 FL
 FM
 FN
 FO
 FP
 FQ
 FR
 FS
 FT
 FU
 FV
 FW
 FX
 FY
 FZ
 GA
 GB
 GC
 GD
 GE
 GF
 GG
 GH
 GI
 GJ
 GK
 GL
 GM
 GN
 GO
 GP
 GQ
 GR
 GS
 GT
 GU
 GV
 GW
 GX
 GY
 GZ
 HA
 HB
 HC
 HD
 HE
 HF
 HG
 HH
 HI
 HJ
 HK
 HL
 HM
 HN
 HO
 HP
 HQ
 HR
 HS
 HT
 HU
 HV
 HW
 HX
 HY
 HZ
 IA
 IB
 IC
 ID
 IE
 IF
 IG
 IH
 II
 IJ
 IK
 IL
 IM
 IN
 IO
 IP
 IQ
 IR
 IS
 IT
 IU
 IV
 IW
 IX
 IY
 IZ
 JA
 JB
 JC
 JD
 JE
 JF
 JG
 JH
 JI
 JJ
 JK
 JL
 JM
 JN
 JO
 JP
 JQ
 JR
 JS
 JT
 JU
 JV
 JW
 JX
 JY
 JZ
 KA
 KB
 KC
 KD
 KE
 KF
 KG
 KH
 KI
 KJ
 KK
 KL
 KM
 KN
 KO
 KP
 KQ
 KR
 KS
 KT
 KU
 KV
 KW
 KX
 KY
 KZ
 LA
 LB
 LC
 LD
 LE
 LF
 LG
 LH
 LI
 LJ
 LK
 LL
 LM
 LN
 LO
 LP
 LQ
 LR
 LS
 LT
 LU
 LV
 LW
 LX
 LY
 LZ
 MA
 MB
 MC
 MD
 ME
 MF
 MG
 MH
 MI
 MJ
 MK
 ML
 MM
 MN
 MO
 MP
 MQ
 MR
 MS
 MT
 MU
 MV
 MW
 MX
 MY
 MZ
 NA
 NB
 NC
 ND
 NE
 NF
 NG
 NH
 NI
 NJ
 NK
 NL
 NM
 NN
 NO
 NP
 NQ
 NR
 NS
 NT
 NU
 NV
 NW
 NX
 NY
 NZ
 OA
 OB
 OC
 OD
 OE
 OF
 OG
 OH
 OI
 OJ
 OK
 OL
 OM
 ON
 OO
 OP
 OQ
 OR
 OS
 OT
 OU
 OV
 OW
 OX
 OY
 OZ
 PA
 PB
 PC
 PD
 PE
 PF
 PG
 PH
 PI
 PJ
 PK
 PL
 PM
 PN
 PO
 PP
 PQ
 PR
 PS
 PT
 PU
 PV
 PW
 PX
 PY
 PZ
 QA
 QB
 QC
 QD
 QE
 QF
 QG
 QH
 QI
 QJ
 QK
 QL
 QM
 QN
 QO
 QP
 QQ
 QR
 QS
 QT
 QU
 QV
 QW
 QX
 QY
 QZ
 RA
 RB
 RC
 RD
 RE
 RF
 RG
 RH
 RI
 RJ
 RK
 RL
 RM
 RN
 RO
 RP
 RQ
 RR
 RS
 RT
 RU
 RV
 RW
 RX
 RY
 RZ
 SA
 SB
 SC
 SD
 SE
 SF
 SG
 SH
 SI
 SJ
 SK
 SL
 SM
 SN
 SO
 SP
 SQ
 SR
 SS
 ST
 SU
 SV
 SW
 SX
 SY
 SZ
 TA
 TB
 TC
 TD
 TE
 TF
 TG
 TH
 TI
 TJ
 TK
 TL
 TM
 TN
 TO
 TP
 TQ
 TR
 TS
 TT
 TU
 TV
 TW
 TX
 TY
 TZ
 UA
 UB
 UC
 UD
 UE
 UF
 UG
 UH
 UI
 UJ
 UK
 UL
 UM
 UN
 UO
 UP
 UQ
 UR
 US
 UT
 UU
 UV
 UW
 UX
 UY
 UZ
 VA
 VB
 VC
 VD
 VE
 VF
 VG
 VH
 VI
 VJ
 VK
 VL
 VM
 VN
 VO
 VP
 VQ
 VR
 VS
 VT
 VU
 VV
 VW
 VX
 VY
 VZ
 WA
 WB
 WC
 WD
 WE
 WF
 WG
 WH
 WI
 WJ
 WK
 WL
 WM
 WN
 WO
 WP
 WQ
 WR
 WS
 WT
 WU
 WV
 WW
 WX
 WY
 WZ
 XA
 XB
 XC
 XD
 XE
 XF
 XG
 XH
 XI
 XJ
 XK
 XL
 XM
 XN
 XO
 XP
 XQ
 XR
 XS
 XT
 XU
 XV
 XW
 XX
 XY
 XZ
 YA
 YB
 YC
 YD
 YE
 YF
 YG
 YH
 YI
 YJ
 YK
 YL
 YM
 YN
 YO
 YP
 YQ
 YR
 YS
 YT
 YU
 YV
 YW
 YX
 YY
 YZ
 ZA
 ZB
 ZC
 ZD
 ZE
 ZF
 ZG
 ZH
 ZI
 ZJ
 ZK
 ZL
 ZM
 ZN
 ZO
 ZP
 ZQ
 ZR
 ZS
 ZT
 ZU
 ZV
 ZW
 ZX
 ZY
 ZZ

Rund-/Flachzangen
 Flat nose pliers
 Alicates de pico plano
 Pincers plates, rondes
 Tenaglie piatte



GOSLEE
 PT 441/14
 14,5 cm/5³/₄"

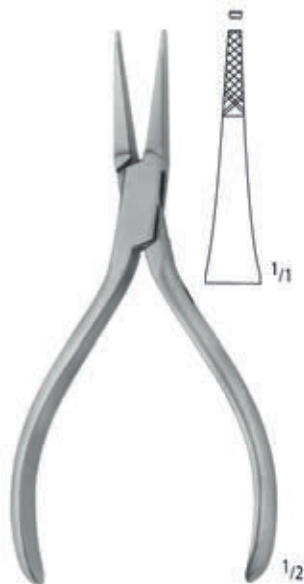

PT 450/14
 14,5 cm/5³/₄"

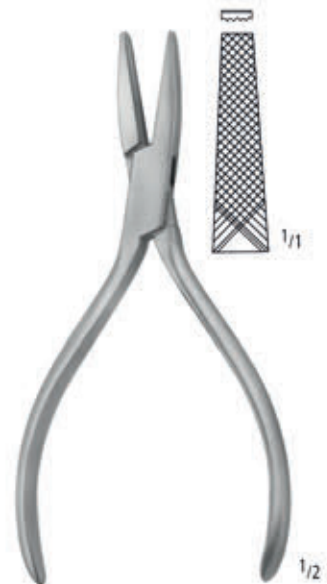

PT 451/14
 14,5 cm/5³/₄"

Teleskopkronenzangen
 Telescopic Crown Pliers
 Alicates para coronas telescópicas
 Pincas pour couronnes télescopes
 Pinza telescopiche per coroni



BÖHM
 PT 461/13
 13,0 cm/5"



PT 462/14
 13,5 cm/5 1/4"

PT 462/02
 Paar Ersatzspitzen zu PT 462/14
 Pair of Tips for PT 462/14
 Pointes de Rechange pour PT 462/14
 Par de Puntas Sustitutivas PT 462/14
 Estrimità Sostitutive per PT 462/14

AA
 AB
 AC
 AD
 AE
 AF
 AK
 AL
 AO
 AR
 KA
 KL
 KU
 PA
 PB
 PF
 PI
 PK
 PL
 PM
 PP
 PS
 PT
 PU
 PV
 KYE

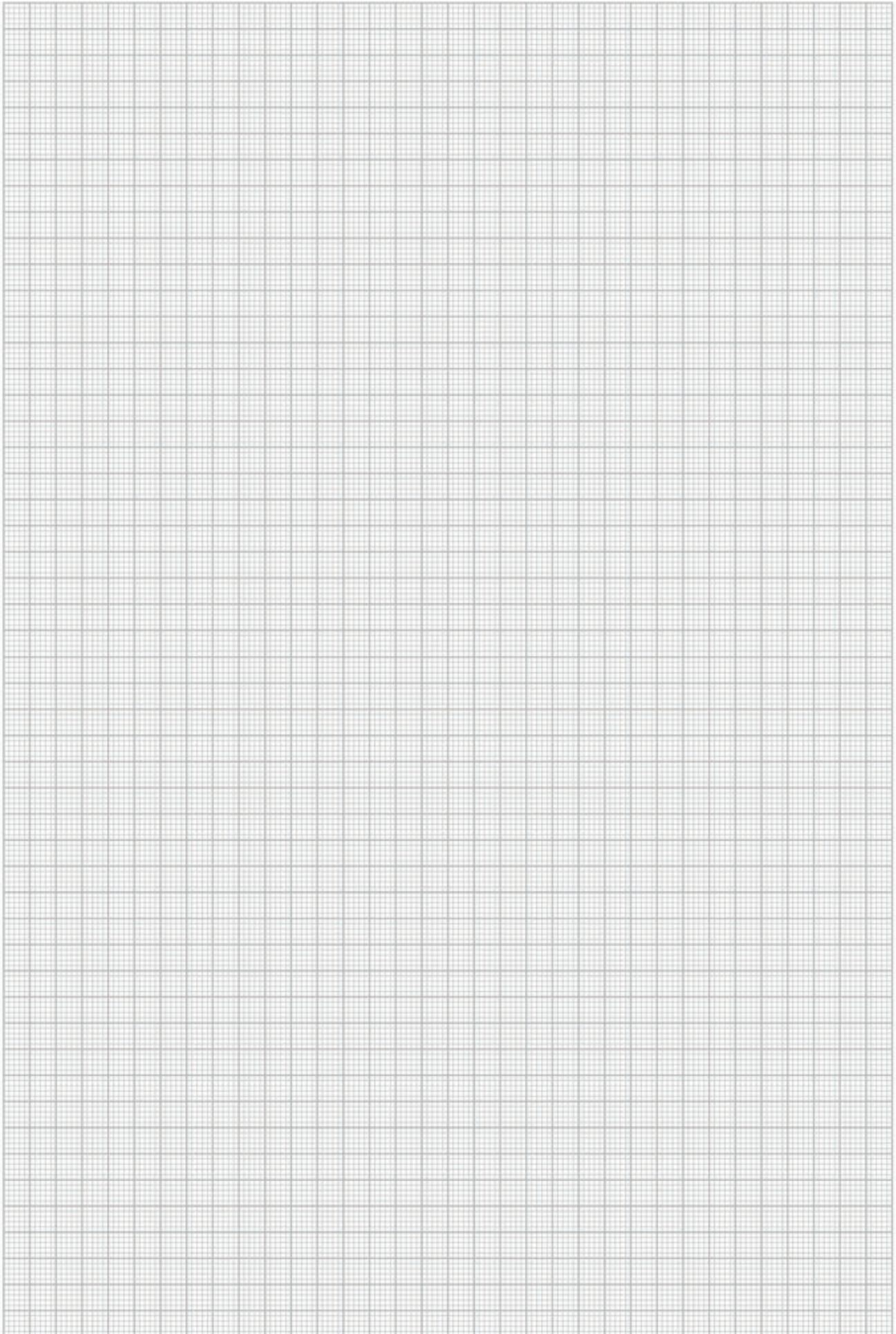

Abdrucklöffel
Impression Trays
Cubetas para impresiones
Porte empreintes
Portaimpronte



Form BO (SUP/B)
für bezahnte Oberkiefer, gelocht
for toothed upper jaws, perforated
para mandibulas superiores dentadas, perforadas
pour maxillaires dentés, perforés
per mascella superiore dentata, perforata

PT 601/00 Fig. 0
PT 601/01 Fig. 1
PT 601/02 Fig. 2
PT 601/03 Fig. 3
PT 601/04 Fig. 4

Fig. 0 für Kinder / for children / para niños
pour enfants / per bambini



Form PO (SUP/P)
für partiell bezahnte Oberkiefer, gelocht
for partially toothed upper jaws, perforated
para mandibulas superiores parcialmente dentadas, perforadas
pour maxillaires partiellement dentés, perforés
per mascella superiore parzialmente dentata, perforata

PT 602/01 Fig. 1
PT 602/02 Fig. 2
PT 602/03 Fig. 3



Form UO (SUP/U)
für unbezahnte Oberkiefer, gelocht
for edentulous upper jaws, perforated
para mandibulas superiores desdentadas, perforadas
pour maxillaires édentés, perforés
per mascella superiore edentula, perforata

PT 603/01 Fig. 1
PT 603/02 Fig. 2
PT 603/03 Fig. 3



Form FO (SUP/F)
für Funktionsabdrücke im Oberkiefer, gelocht
for upper functional impressions, perforated
para impresiones funcionales superiores, perforadas
pour maxillaires, empreintes fonctionelles, perforés
per impronte funzionali nella mascella superiore dentata, perforata

PT 604/01 Fig. 1
PT 604/02 Fig. 2
PT 604/03 Fig. 3

AA
AB
AC
AD
AE
AF
AK
AL
AO
AR
KA
KL
KU
PA
PB
PF
PI
PK
PL
PM
PP
PS
PU
PV
KYE

PT

Abdrucklöffel
 Impression Trays
 Cubetas para impresiones
 Porte empreintes
 Portaimpronte



Form BU (INF/B)
 für bezahnte Unterkiefer, gelocht
 for toothed lower jaws, perforated
 para mandibulas inferiores dentadas, perforadas
 pour mandibules dentés, perforés
 per mascella inferiore dentata, perforata

Form PU (INF/P)
 für partiell bezahnte Unterkiefer, gelocht
 for partially toothed lower jaws, perforated
 para mandibulas inferiores parcialmente dentadas, perforadas
 pour mandibules partiellement dentés, perforés
 per mascella inferiore parzialmente dentata, perforata

- PT 610/00 Fig. 0
- PT 610/01 Fig. 1
- PT 610/02 Fig. 2
- PT 610/03 Fig. 3
- PT 610/04 Fig. 4

- PT 611/01 Fig. 1
- PT 611/02 Fig. 2
- PT 611/03 Fig. 3

Fig. 0 für Kinder / for children / para niños
 pour enfants / per bambini



Form UU (INF/U)
 für unbezahnte Unterkiefer, gelocht
 for edentulous lower jaws, perforated
 para mandibulas inferiores desdentadas, perforadas
 pour mandibules édentés, perforés
 per mascella inferiore edentula, perforata

- PT 612/01 Fig. 1
- PT 612/02 Fig. 2
- PT 612/03 Fig. 3

Abdrucklöffel
Impression Trays
Cubetas para impresiones
Porte empreintes
Portaimpronte



Form BO (SUP/B)
für bezahnte Oberkiefer, ungelocht
for toothed upper jaws, non perforated
para mandibulas superiores dentadas, no perforadas
pour maxillaires dentés, non perforés
per mascella superiore dentata, non perforata

Form PO (SUP/P)
für partiell bezahnte Oberkiefer, ungelocht
for partially toothed upper jaws, non perforated
para mandibulas superiores parcialmente dentadas, no perforadas
pour maxillaires partiellement dentés, non perforés
per mascella superiore parzialmente dentata, non perforata

- PT 621/00 Fig. 0
- PT 621/01 Fig. 1
- PT 621/02 Fig. 2
- PT 621/03 Fig. 3
- PT 621/04 Fig. 4

- PT 622/01 Fig. 1
- PT 622/02 Fig. 2
- PT 622/03 Fig. 3

Fig. 0 für Kinder / for children / para niños
pour enfants / per bambini



Form UO (SUP/U)
für unbezahnte Oberkiefer, ungelocht
for edentulous upper jaws, non perforated
para mandibulas superiores desdentadas, no perforadas
pour maxillaires édentés, non perforés
per mascella superiore edentula, non perforata

Form FO (SUP/F)
für Funktionsabdrücke im Oberkiefer, ungelocht
for upper functional impressions, non perforated
para impresiones funcionales superiores, non perforadas
pour maxillaires, empreintes fonctionelles, non perforés
per impronte funzionali nella mascella superiore dentata, non perforata

- PT 623/01 Fig. 1
- PT 623/02 Fig. 2
- PT 623/03 Fig. 3

- PT 624/01 Fig. 1
- PT 624/02 Fig. 2
- PT 624/03 Fig. 3

AA
AB
AC
AD
AE
AF
AK
AL
AO
AR
KA
KL
KU
PA
PB
PF
PI
PK
PL
PM
PP
PS
PT
PU
PV
KYE

Abdrucklöffel
 Impression Trays
 Cubetas para impresiones
 Porte empreintes
 Portaimpronte



Form BU (INF/B)
 für bezahnte Unterkiefer, ungelocht
 for toothed lower jaws, non perforated
 para mandibulas inferiores dentadas, no perforadas
 pour mandibulas dentés, non perforés
 per mascella inferiore dentata, non perforata

- PT 630/00 Fig. 0
- PT 630/01 Fig. 1
- PT 630/02 Fig. 2
- PT 630/03 Fig. 3
- PT 630/04 Fig. 4

Fig. 0 für Kinder / for children / para niños
 pour enfants / per bambini



Form PU (INF/P)
 für partiell bezahnte Unterkiefer, ungelocht
 for partially toothed lower jaws, non perforated
 para mandibulas inferiores parcialmente dentadas, no perforadas
 pour mandibulas partiellement dentés, non perforés
 per mascella inferiore parzialmente dentata, non perforata

- PT 631/01 Fig. 1
- PT 631/02 Fig. 2
- PT 631/03 Fig. 3



Form UU (INF/U)
 für unbezahnte Unterkiefer, ungelocht
 for edentulous lower jaws, non perforated
 para mandibulas inferiores desdentadas, no perforadas
 pour mandibulas édentés, non perforés
 per mascella inferiore edentula, non perforata

- PT 632/01 Fig. 1
- PT 632/02 Fig. 2
- PT 632/03 Fig. 3

Abdrucklöffel für partielle Abdrücke
 Impression trays for partial impressions
 Cubetas para impresiones parciales
 Porte empreintes partiels
 Portaimpronte parziali



Form C1/2L
 gelocht
 perforated
 perforada
 perforé
 perforato

PT 650/01 Fig. 1
 PT 650/02 Fig. 2
 PT 650/03 Fig. 3



Form C1/2R
 gelocht
 perforated
 perforada
 perforé
 perforato

PT 651/01 Fig. 1
 PT 651/02 Fig. 2
 PT 651/03 Fig. 3



PT 655/01

gelocht
 perforated
 perforada
 perforé
 perforato



PT 655/02

mit drehbarem Griff
 with swivel handle
 con mango giratorio
 avec poignée pivotante
 con impugnatura girevole
 gelocht
 perforated
 perforada
 perforé
 perforato

AA
 AB
 AC
 AD
 AE
 AF
 AG
 AH
 AI
 AJ
 AK
 AL
 AM
 AN
 AO
 AP
 AQ
 AR
 AS
 AT
 AU
 AV
 AW
 AX
 AY
 AZ
 BA
 BB
 BC
 BD
 BE
 BF
 BG
 BH
 BI
 BJ
 BK
 BL
 BM
 BN
 BO
 BP
 BQ
 BR
 BS
 BT
 BU
 BV
 BW
 BX
 BY
 BZ
 CA
 CB
 CC
 CD
 CE
 CF
 CG
 CH
 CI
 CJ
 CK
 CL
 CM
 CN
 CO
 CP
 CQ
 CR
 CS
 CT
 CU
 CV
 CW
 CX
 CY
 CZ
 DA
 DB
 DC
 DD
 DE
 DF
 DG
 DH
 DI
 DJ
 DK
 DL
 DM
 DN
 DO
 DP
 DQ
 DR
 DS
 DT
 DU
 DV
 DW
 DX
 DY
 DZ
 EA
 EB
 EC
 ED
 EE
 EF
 EG
 EH
 EI
 EJ
 EK
 EL
 EM
 EN
 EO
 EP
 EQ
 ER
 ES
 ET
 EU
 EV
 EW
 EX
 EY
 EZ
 FA
 FB
 FC
 FD
 FE
 FF
 FG
 FH
 FI
 FJ
 FK
 FL
 FM
 FN
 FO
 FP
 FQ
 FR
 FS
 FT
 FU
 FV
 FW
 FX
 FY
 FZ
 GA
 GB
 GC
 GD
 GE
 GF
 GG
 GH
 GI
 GJ
 GK
 GL
 GM
 GN
 GO
 GP
 GQ
 GR
 GS
 GT
 GU
 GV
 GW
 GX
 GY
 GZ
 HA
 HB
 HC
 HD
 HE
 HF
 HG
 HH
 HI
 HJ
 HK
 HL
 HM
 HN
 HO
 HP
 HQ
 HR
 HS
 HT
 HU
 HV
 HW
 HX
 HY
 HZ
 IA
 IB
 IC
 ID
 IE
 IF
 IG
 IH
 II
 IJ
 IK
 IL
 IM
 IN
 IO
 IP
 IQ
 IR
 IS
 IT
 IU
 IV
 IW
 IX
 IY
 IZ
 JA
 JB
 JC
 JD
 JE
 JF
 JG
 JH
 JI
 JJ
 JK
 JL
 JM
 JN
 JO
 JP
 JQ
 JR
 JS
 JT
 JU
 JV
 JW
 JX
 JY
 JZ
 KA
 KB
 KC
 KD
 KE
 KF
 KG
 KH
 KI
 KJ
 KK
 KL
 KM
 KN
 KO
 KP
 KQ
 KR
 KS
 KT
 KU
 KV
 KW
 KX
 KY
 KZ
 LA
 LB
 LC
 LD
 LE
 LF
 LG
 LH
 LI
 LJ
 LK
 LL
 LM
 LN
 LO
 LP
 LQ
 LR
 LS
 LT
 LU
 LV
 LW
 LX
 LY
 LZ
 MA
 MB
 MC
 MD
 ME
 MF
 MG
 MH
 MI
 MJ
 MK
 ML
 MM
 MN
 MO
 MP
 MQ
 MR
 MS
 MT
 MU
 MV
 MW
 MX
 MY
 MZ
 NA
 NB
 NC
 ND
 NE
 NF
 NG
 NH
 NI
 NJ
 NK
 NL
 NM
 NN
 NO
 NP
 NQ
 NR
 NS
 NT
 NU
 NV
 NW
 NX
 NY
 NZ
 OA
 OB
 OC
 OD
 OE
 OF
 OG
 OH
 OI
 OJ
 OK
 OL
 OM
 ON
 OO
 OP
 OQ
 OR
 OS
 OT
 OU
 OV
 OW
 OX
 OY
 OZ
 PA
 PB
 PC
 PD
 PE
 PF
 PG
 PH
 PI
 PJ
 PK
 PL
 PM
 PN
 PO
 PP
 PQ
 PR
 PS
 PT
 PU
 PV
 PW
 PX
 PY
 PZ
 QA
 QB
 QC
 QD
 QE
 QF
 QG
 QH
 QI
 QJ
 QK
 QL
 QM
 QN
 QO
 QP
 QQ
 QR
 QS
 QT
 QU
 QV
 QW
 QX
 QY
 QZ
 RA
 RB
 RC
 RD
 RE
 RF
 RG
 RH
 RI
 RJ
 RK
 RL
 RM
 RN
 RO
 RP
 RQ
 RR
 RS
 RT
 RU
 RV
 RW
 RX
 RY
 RZ
 SA
 SB
 SC
 SD
 SE
 SF
 SG
 SH
 SI
 SJ
 SK
 SL
 SM
 SN
 SO
 SP
 SQ
 SR
 SS
 ST
 SU
 SV
 SW
 SX
 SY
 SZ
 TA
 TB
 TC
 TD
 TE
 TF
 TG
 TH
 TI
 TJ
 TK
 TL
 TM
 TN
 TO
 TP
 TQ
 TR
 TS
 TT
 TU
 TV
 TW
 TX
 TY
 TZ
 UA
 UB
 UC
 UD
 UE
 UF
 UG
 UH
 UI
 UJ
 UK
 UL
 UM
 UN
 UO
 UP
 UQ
 UR
 US
 UT
 UU
 UV
 UW
 UX
 UY
 UZ
 VA
 VB
 VC
 VD
 VE
 VF
 VG
 VH
 VI
 VJ
 VK
 VL
 VM
 VN
 VO
 VP
 VQ
 VR
 VS
 VT
 VU
 VV
 VW
 VX
 VY
 VZ
 WA
 WB
 WC
 WD
 WE
 WF
 WG
 WH
 WI
 WJ
 WK
 WL
 WM
 WN
 WO
 WP
 WQ
 WR
 WS
 WT
 WU
 WV
 WW
 WX
 WY
 WZ
 XA
 XB
 XC
 XD
 XE
 XF
 XG
 XH
 XI
 XJ
 XK
 XL
 XM
 XN
 XO
 XP
 XQ
 XR
 XS
 XT
 XU
 XV
 XW
 XX
 XY
 XZ
 YA
 YB
 YC
 YD
 YE
 YF
 YG
 YH
 YI
 YJ
 YK
 YL
 YM
 YN
 YO
 YP
 YQ
 YR
 YS
 YT
 YU
 YV
 YW
 YX
 YZ
 ZA
 ZB
 ZC
 ZD
 ZE
 ZF
 ZG
 ZH
 ZI
 ZJ
 ZK
 ZL
 ZM
 ZN
 ZO
 ZP
 ZQ
 ZR
 ZS
 ZT
 ZU
 ZV
 ZW
 ZX
 ZY
 ZZ

Abdrucklöffel für partielle Abdrücke
 Impression trays for partial impressions
 Cubetas para impresiones parciales
 Porte empreintes partiels
 Portaimpronte parziali



1/2

Form C1/2L
 ungelocht
 unperforated
 no perforada
 non perforé
 non perforato

PT 660/01 Fig. 1
 PT 660/02 Fig. 2
 PT 660/03 Fig. 3



1/2

Form C1/2R
 ungelocht
 unperforated
 no perforada
 non perforé
 non perforato

PT 661/01 Fig. 1
 PT 661/02 Fig. 2
 PT 661/03 Fig. 3



1/2

PT 665/01

ungelocht
 unperforated
 no perforada
 non perforé
 non perforato



1/2

PT 665/02

mit drehbarem Griff
 with swivel handle
 con mango giratorio
 avec poignée pivotante
 con impugnatura girevole
 ungelocht
 unperforated
 no perforada
 non perforé
 non perforato

MATRIZEN
MATRIX
MATRICES
MATRICES
MATRICI

PU

nopa[®] instruments



MATRIZEN MATRIX MATRICES MATRICES MATRICI

Matrizen und Matrizenspanner
 Matrix bands and retainers
 Portamatrices y matrices
 Porte matrices et matrices
 Portamatrici e matrici



IVORY
 PU 020/01
 Fig. 1



IVORY
 PU 020/12
 Fig. 12



IVORY
 PU 021/12
 Fig. 12A

12 Stück
 12 pieces
 12 piezas
 12 pièces
 12 pezzi



Fig. 1
 PU 022/01



Fig. 2
 PU 022/02



Fig. 3
 PU 022/03

12 Stück
 12 pieces
 12 piezas
 12 pièces
 12 pezzi



Fig. 4
 PU 022/04



Fig. 5
 PU 022/05



Fig. 6
 PU 022/06

AA
 AB
 AC
 AD
 AE
 AF
 AK
 AL
 AO
 AR
 KA
 KL
 KU
 PA
 PB
 PF
 PI
 PK
 PL
 PM
 PP
 PS
 PT
 PU
 PV
 KYE

Matrizen und Matrizenspanner
 Matrix bands and retainers
 Portamatrices y matrices
 Porte matrices et matrices
 Portamatrici e matrici



IVORY
 PU 040/05
 Fig. 8
 5 mm



IVORY
 PU 040/06
 Fig. 8
 6 mm



Fig. 7
 PU 041/07



Fig. 8
 PU 041/08



Fig. 9
 PU 041/09



Fig. 10
 PU 041/10



Fig. 11
 PU 041/11



Fig. 12
 PU 041/12



Fig. 13
 PU 041/13

MATRIZEN MATRIX MATRICES MATRICES MATRICI

Matrizen und Matrizenspanner
 Matrix bands and retainers
 Portamatrices y matrices
 Porte matrices et matrices
 Portamatrici e matrici

AA
AB
AC
AD
AE
AF
AK
AL
AO
AR
KA
KL
KU
PA
PB
PF
PI
PK
PL
PM
PP
PS
PT
PU
PV
KYE



- PU 042/05 5 mm x 1 m
- PU 042/06 6 mm x 1 m
- PU 042/07 7 mm x 1 m



TOFFLEMIRE-UNIVERSAL
 PU 050/00



- 12 Stück
- 12 pieces
- 12 piezas
- 12 pièces
- 12 pezzi

TOFFLEMIRE
 PU 051/01
 Fig. 1



TOFFLEMIRE
 PU 051/13
 Fig. 13

PU MATRIZEN MATRIX MATRICES MATRICES MATRICI

Kofferdam-Lochzange, Kofferdam-Klammerzange
 Punch forceps, clamp forceps
 Perforadores, portaclamps
 Pincès à perforer, pincès porte crampons
 Pinze foradiga, pinze per uncini



AINSWORTH
 PU 080/16
 16,0 cm/6¹/₄"



USA
 PU 081/15
 15,0 cm/6"



STOCKES
 PU 082/17
 17,0 cm/6³/₄"



IVORY
 PU 083/16
 16,0 cm/6¹/₄"



BREWER
 PU 084/17
 17,0 cm/6³/₄"

IMPLANTOLOGIE
IMPLANTOLOGY
IMPLANTOLOGIA
IMPLANTOLOGIE
IMPLANTOLOGIA

PV

nopa[®] instruments



Applikationsspritzen
 Application syringes
 Jeringas de aplicaci3n
 Seringue d'application
 Siringa di applicazione



PV 010/12
 1,2 mm



PV 011/12
 1,2 mm



PV 015/18
 1,8 mm

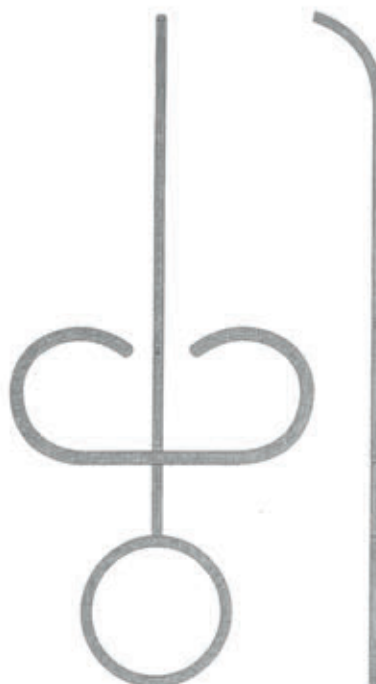

PV 017/18
 1,8 mm

AA AB AC AD AE AF AG AH AI AJ AK AL AM AN AO AP AQ AR AS AT AU AV AW AX AY AZ
 BA BB BC BD BE BF BG BH BI BJ BK BL BM BN BO BP BQ BR BS BT BU BV BW BX BY BZ
 CA CB CC CD CE CF CG CH CI CJ CK CL CM CN CO CP CQ CR CS CT CU CV CW CX CY CZ
 DA DB DC DD DE DF DG DH DI DJ DK DL DM DN DO DP DQ DR DS DT DU DV DW DX DY DZ
 EA EB EC ED EE EF EG EH EI EJ EK EL EM EN EO EP EQ ER ES ET EU EV EW EX EY EZ
 FA FB FC FD FE FF FG FH FI FJ FK FL FM FN FO FP FQ FR FS FT FU FV FW FX FY FZ
 GA GB GC GD GE GF GG GH GI GJ GK GL GM GN GO GP GQ GR GS GT GU GV GW GX GY GZ
 HA HB HC HD HE HF HG HH HI HJ HK HL HM HN HO HP HQ HR HS HT HU HV HW HX HY HZ
 IA IB IC ID IE IF IG IH II IJ IK IL IM IN IO IP IQ IR IS IT IU IV IW IX IY IZ
 JA JB JC JD JE JF JG JH JI JJ JK JL JM JN JO JP JQ JR JS JT JU JV JW JX JY JZ
 KA KB KC KD KE KF KG KH KI KJ KL KM KN KO KP KQ KR KS KT KU KV KW KX KY KZ
 LA LB LC LD LE LF LG LH LI LJ LK LL LM LN LO LP LQ LR LS LT LU LV LW LX LY LZ
 MA MB MC MD ME MF MG MH MI MJ MK ML MN MO MP MQ MR MS MT MU MV MW MX MY MZ
 NA NB NC ND NE NF NG NH NI NJ NK NL NO NP NQ NR NS NT NU NV NW NX NY NZ
 OA OB OC OD OE OF OG OH OI OJ OK OL OM ON OO OP OQ OR OS OT OU OV OW OX OY OZ
 PA PB PC PD PE PF PG PH PI PJ PK PL PM PN PO PP PQ PR PS PT PU PV PW PX PY PZ
 QA QB QC QD QE QF QG QH QI QJ QK QL QM QN QO QQ QR QS QT QU QV QW QX QY QZ
 RA RB RC RD RE RF RG RH RI RJ RK RL RM RN RO RP RQ RR RS RT RU RV RW RX RY RZ
 SA SB SC SD SE SF SG SH SI SJ SK SL SM SN SO SP SQ SR SS ST SU SV SW SX SY SZ
 TA TB TC TD TE TF TG TH TI TJ TK TL TM TN TO TP TQ TR TS TT TU TV TW TX TY TZ
 UA UB UC UD UE UF UG UH UI UJ UK UL UM UN UO UP UQ UR US UT UY UZ
 VA VB VC VD VE VF VG VH VI VJ VK VL VM VN VO VP VQ VR VS VT VY VZ
 WA WB WC WD WE WF WG WH WI WJ WK WL WM WN WO WP WQ WR WS WT WY WZ
 XA XB XC XD XE XF XG XH XI XJ XK XL XM XN XO XP XQ XR XS XT XU XV XW XX XY XZ
 YA YB YC YD YE YF YG YH YI YJ YK YL YM YN YO YP YQ YR YS YT YU YV YW YX YZ
 ZA ZB ZC ZD ZE ZF ZG ZH ZI ZJ ZK ZL ZM ZN ZO ZP ZQ ZR ZS ZT ZU ZV ZW ZX ZY ZZ

PV

KYE

Knochenspritzen
 Bone carriers
 Jeringas de hueso
 Seringue à os
 Siringhe per osso



Fig. 01
 PV 020/01
 2,5/3,5 mm



Fig. 02
 PV 020/02
 3,5/4,5 mm

Knochenspritzen
 Bone carriers
 Jeringas de hueso
 Seringue à os
 Siringhe per osso



Fig. 03
 PV 020/03
 4,5/5,5 mm

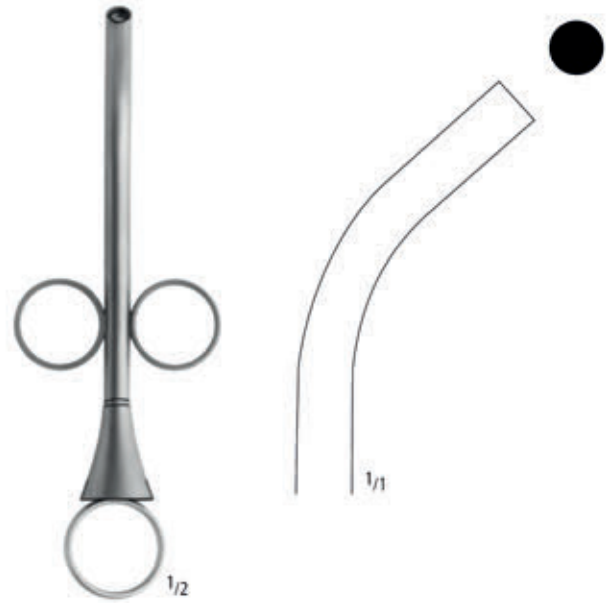
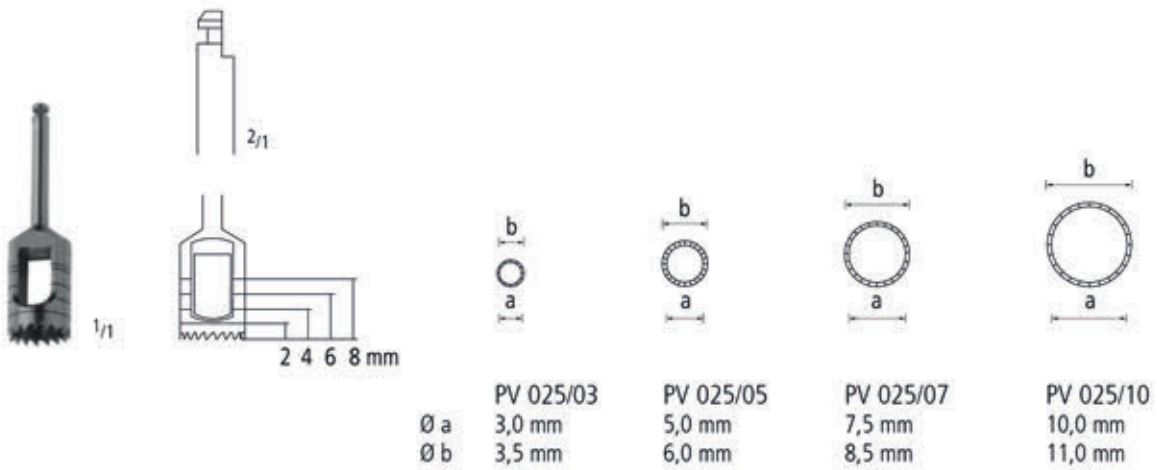

Fig. 04
 PV 020/04
 6/7 mm

AA
 AB
 AC
 AD
 AE
 AF
 AK
 AL
 AO
 AR
 KA
 KL
 KU
 PA
 PB
 PF
 PI
 PK
 PL
 PM
 PP
 PS
 PT
 PU
PV
 KYE

Trepanbohrer, Implantat-Messzange
 Trepine burrs, implantology caliper
 Fresas trephines, calibreadores de implantología
 Fraises trépan, calibre d'implantologie
 Frese trephine, calibre per implantologia



PV 030/15
 15,0 cm/6"



PV 031/15
 15,0 cm/6"

Knochenmühle
 Bone mill
 Molino de huesos
 Broyer d'os
 Mulino d'osso



PV 759/00

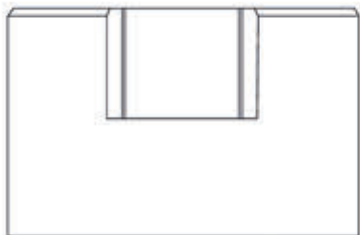
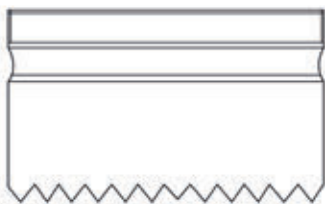
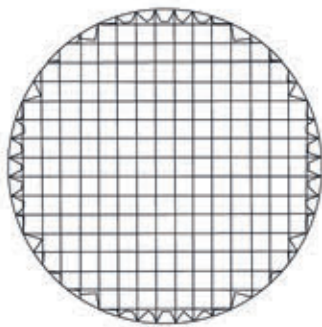

1/1



PV 760/00
 16,5 cm/6 1/2"

AA AB AC AD AE AF AK AL AO AR KA KL KU PA PB PF PI PK PL PM PP PS PT PU PV

PV

KYE

STERILISATIONSBEHÄLTNISSE
UND NORM-TRAYS

STERILIZING CONTAINERS
AND STANDARD TRAYS

CAJAS PARA ESTERILIZACION
Y BANDEJAS ESTANDAR

DES BOITES A INSTRUMENTS ET POUR LA
STERILISATION ET TRAYS STANDARD

ASTUCCI PER LA STERILIZZAZIONE
E BACINELLE STANDARD

KYE

nopa[®] instruments

Unser komplettes Container Programm finden Sie
in unserem Katalog „Container System“.

For our complete range of sterilizing containers
kindly refer to our catalogue „Container system“.

Para nuestro gama completa de contenedores,
por favor consulte nuestro catálogo de
„Sistema de contenedor“.

Pour notre gamme complet des conteneurs, consultez
notre catalogue „Système de conteneur“.

Per nostro assortimento completo di contenitore,
consultare il nostro catalogo „Sistema del Contenitore“.



Dental Container



Nur Deckel farbig
Lid colored only
Solamente tapas en diferentes colores
Couvercle de couleur seulement
Solo coperchio colorato

L(mm)	B(mm)	H(mm)						
310	190	40	KYE 370/01	KYE 370/02	KYE 370/03	KYE 370/04	KYE 370/05	KYE 370/06
310	190	65	KYE 371/01	KYE 371/02	KYE 371/03	KYE 371/04	KYE 371/05	KYE 371/06
310	190	130	KYE 372/01	KYE 372/02	KYE 372/03	KYE 372/04	KYE 372/05	KYE 372/06



Nur Deckel farbig
Lid colored only
Solamente tapas en diferentes colores
Couvercle de couleur seulement
Solo coperchio colorato

L(mm)	B(mm)	H(mm)						
310	190	40	KYE 373/01	KYE 373/02	KYE 373/03	KYE 373/04	KYE 373/05	KYE 373/06
310	190	65	KYE 374/01	KYE 374/02	KYE 374/03	KYE 374/04	KYE 374/05	KYE 374/06
310	190	130	KYE 375/01	KYE 375/02	KYE 375/03	KYE 375/04	KYE 375/05	KYE 375/06

AA
AB
AC
AD
AE
AF
AK
AL
AO
AR
KA
KL
KU
PA
PB
PF
PI
PK
PL
PM
PP
PS
PT
PU
PV
KYE



L(mm)	B(mm)	H(mm)	
310	190	40	KYE 365/04
310	190	65	KYE 365/06
310	190	130	KYE 365/13



L(mm)	B(mm)	H(mm)	
310	190	40	KYE 366/04
310	190	65	KYE 366/06
310	190	130	KYE 366/13



L(mm)	B(mm)
310	190



L(mm)	B(mm)
310	190





L(mm)	B(mm)	H(mm)	
274	172	43	SK 435/04

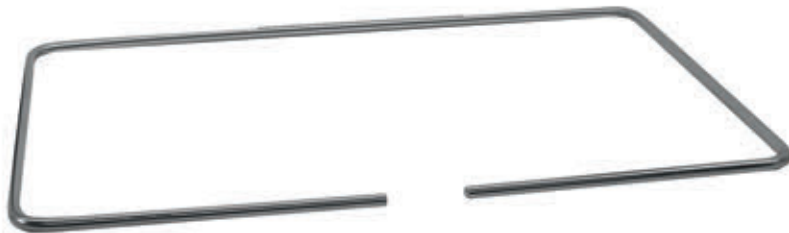

L(mm)	B(mm)	
274	172	SK 435/61

- >> BÜRSTENSPENDER FÜR 20 BÜRSTEN (OHNE BÜRSTEN)
- >> BRUSH DISPENSER FOR 20 BRUSHES (WITHOUT BRUSHES)
- >> DISTRIBUIDOR DE CEPILLOS PARA 20 CEPILLOS (SIN CEPILLOS)
- >> DISTRIBUTEUR DE BROSSES POUR 20 BROSSES (SANS BROSSES)
- >> DISTRIBUTORE DI SPAZZOLE PER 20 SPAZZOLE (SENZA SPAZZOLE)



KY 900/00
 autoklavierbar
 autoclavable
 autoclavable
 autoclavable
 autoclavabile

AA
AB
AC
AD
AE
AF
AK
AL
AO
AR
KA
KL
KU
PA
PB
PF
PI
PK
PL
PM
PP
PS
PT
PU
PV

KYE

Norm-Trays und Zubehör
Standard trays and accessories
Bandejas estándar y accesorios
Trays standard et accessoires
Bacinelle standard ed accessori

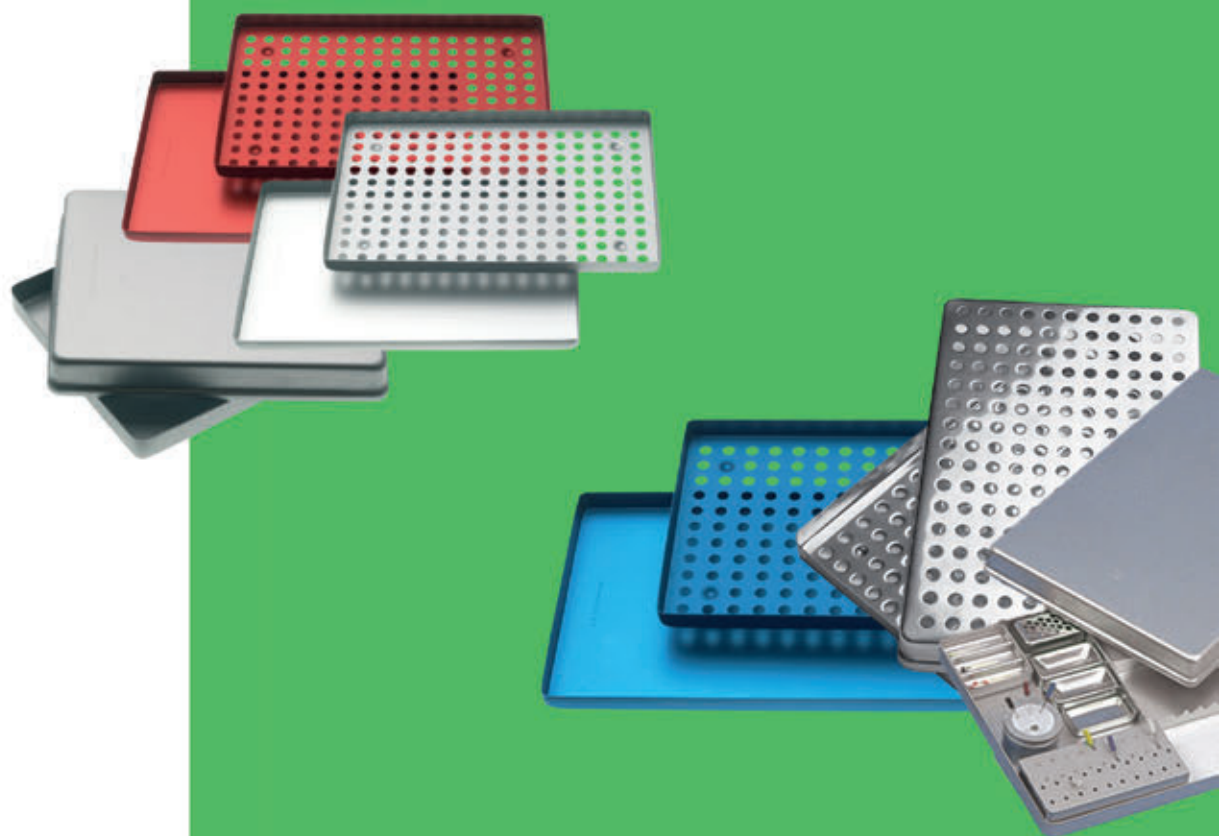

ALU

NORM-TRAYS



L(mm) B(mm) H(mm)

285 185 40
601/05



KY 601/01



KY 601/02



KY 601/03



KY 601/04



KY

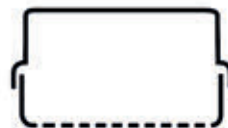

L(mm) B(mm) H(mm)

285 185 40
602/05



KY 602/01



KY 602/02



KY 602/03



KY 602/04



KY

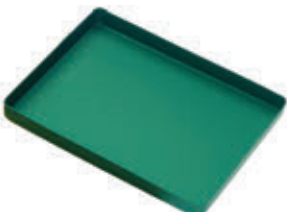

L(mm) B(mm) H(mm)

285 185 17
605/05

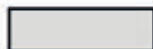

KY 605/01



KY 605/02



KY 605/03



KY 605/04



KY

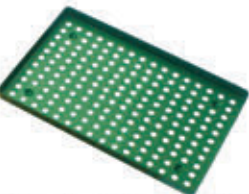

L(mm) B(mm) H(mm)

285 185 17
606/05

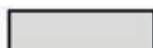

KY 606/01



KY 606/02



KY 606/03



KY 606/04



KY



L(mm) B(mm) H(mm)

285 185 26



KY 607/01

ALU



für 10 Instrumente
for 10 instruments

KY 610/10



für 14 Instrumente
for 14 instruments

KY 610/14

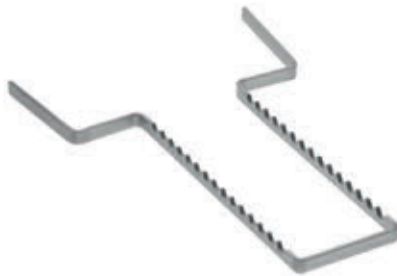

für 15 Instrumente
for 15 instruments

KY 610/15



KY 612/07
78 x 40 x 7 mm



KY 612/24
105 x 50 x 24 mm



KY 613/03
50 x 50 x 12 mm



KY 613/12
90 x 45 x 12 mm

AA AB AC AD AE AF AG AH AI AJ AK AL AM AN AO AP AQ AR AS AT AU AV AW AX AY AZ BA BB BC BD BE BF BG BH BI BJ BK BL BM BN BO BP BQ BR BS BT BU BV BW BX BY BZ CA CB CC CD CE CF CG CH CI CJ CK CL CM CN CO CP CQ CR CS CT CU CV CW CX CY CZ DA DB DC DE DF DG DH DI DJ DK DL DM DN DO DP DQ DR DS DT DU DV DW DX DY DZ EA EB EC ED EE EF EG EH EI EJ EK EL EM EN EO EP EQ ER ES ET EU EV EW EX EY EZ FA FB FC FD FE FF FG FH FI FJ FK FL FM FN FO FP FQ FR FS FT FU FV FW FX FY FZ GA GB GC GD GE GF GG GH GI GJ GK GL GM GN GO GP GQ GR GS GT GU GV GW GX GY GZ HA HB HC HD HE HF HG HH HI HJ HK HL HM HN HO HP HQ HR HS HT HU HV HW HX HY HZ IA IB IC ID IE IF IG IH II IJ IK IL IM IN IO IP IQ IR IS IT IU IV IW IX IY IZ JA JB JC JD JE JF JG JH JI JJ JK JL JM JN JO JP JQ JR JS JT JU JV JW JX JY JZ KA KB KC KD KE KF KG KH KI KJ KL KM KN KO KP KQ KR KS KT KU KV KW KX KY KZ LA LB LC LD LE LF LG LH LI LJ LK LL LM LN LO LP LQ LR LS LT LU LV LW LX LY LZ MA MB MC MD ME MF MG MH MI MJ MK ML MN MO MP MQ MR MS MT MU MV MW MX MY MZ NA NB NC ND NE NF NG NH NI NJ NK NL NM NO NP NQ NR NS NT NU NV NW NX NY NZ OA OB OC OD OE OF OG OH OI OJ OK OL OM ON OO OP OQ OR OS OT OU OV OW OX OY OZ PA PB PC PD PE PF PG PH PI PJ PK PL PM PN PO PP PQ PR PS PT PU PV PW PX PY PZ QA QB QC QD QE QF QG QH QI QJ QK QL QM QN QO QP QQ QR QS QT QU QV QW QX QY QZ RA RB RC RD RE RF RG RH RI RJ RK RL RM RN RO RP RQ RR RS RT RU RV RW RX RY RZ SA SB SC SD SE SF SG SH SI SJ SK SL SM SN SO SP SQ SR SS ST SU SV SW SX SY SZ TA TB TC TD TE TF TG TH TI TJ TK TL TM TN TO TP TQ TR TS TT TU TV TW TX TY TZ UA UB UC UD UE UF UG UH UI UJ UK UL UM UN UO UP UQ UR US UT UU UV UW UX UY UZ VA VB VC VD VE VF VG VH VI VJ VK VL VM VN VO VP VQ VR VS VT VU VV VW VX VY VZ WA WB WC WD WE WF WG WH WI WJ WK WL WM WN WO WP WQ WR WS WT WU WV WW WX WY WZ XA XB XC XD XE XF XG XH XI XJ XK XL XM XN XO XP XQ XR XS XT XU XV XW XX XY XZ YA YB YC YD YE YF YG YH YI YJ YK YL YM YN YO YP YQ YR YS YT YU YV YW YX YY YZ ZA ZB ZC ZD ZE ZF ZG ZH ZI ZJ ZK ZL ZM ZN ZO ZP ZQ ZR ZS ZT ZU ZV ZW ZX ZY ZZ

KYE

ALU

MINI



L(mm)	B(mm)	H(mm)					
184 621/05	140	40	KY 621/01	KY 621/02	KY 621/03	KY 621/04	KY

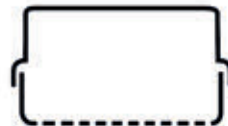

L(mm)	B(mm)	H(mm)					
184 622/05	140	40	KY 622/01	KY 622/02	KY 622/03	KY 622/04	KY

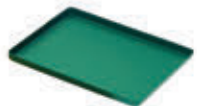

L(mm)	B(mm)	H(mm)					
184 625/05	140	17	KY 625/01	KY 625/02	KY 625/03	KY 625/04	KY



L(mm)	B(mm)	H(mm)					
184 626/05	140	17	KY 626/01	KY 626/02	KY 626/03	KY 626/04	KY



L(mm)	B(mm)	H(mm)	
184	140	26	KY 627/01

MINI

ALU



für 7 Instrumente
for 7 instruments

KY 630/07



für 10 Instrumente
for 10 instruments

KY 630/10



KY 632/12
40 x 40 x 12 mm



KY 632/24
52 x 50 x 24 mm

AA
AB
AC
AD
AE
AF
AK
AL
AO
AR
KA
KL
KU
PA
PB
PF
PI
PK
PL
PM
PP
PS
PT
PU
PV

KYE

ALU



KY 635/00

Endodontic Tray S

KY 635/00 =	KY 635/01	Grey Tray and Lid	1 pc
	KY 635/02	Insert Frame S	1 pc
	KY 635/03	Reamer Stand	1 pc
	KY 635/04	Pellet Container	1 pc
	KY 635/05	Burr	1 pc
	KY 635/06	Box	1 pc
	KY 635/07	Clean-Grip	1 pc
	KY 635/08	Box for Points	1 pc
	KY 635/09	Medicament Cups	2 pc



KY 636/00

Endodontic Mini Tray S

KY 636/00 =	KY 636/01	Grey Tray and Lid	1
	pc		
	KY 636/02	Insert Mini Endo	1 pc
	KY 636/03	Box for Points	1 pc
	KY 636/04	Medicament Cup	1 pc
	KY 636/05	Clean Grip	1 pc
	KY 636/06	Reamer Stand Mini	1 pc

NORM-TRAYS

STAINLESS STEEL



L(mm)	B(mm)	H(mm)	
284	184	40	KY 650/01



L(mm)	B(mm)	H(mm)	
284	184	40	KY 650/02



L(mm)	B(mm)	H(mm)	
284	184	17	KY 653/01



L(mm)	B(mm)	H(mm)	
284	184	17	KY 653/02



L(mm)	B(mm)	H(mm)	
287	186	26	KY 654/01



L(mm)	B(mm)	H(mm)	
287	186	26	KY 654/02



AA AB AC AD AE AF AG AH AI AJ AK AL AM AN AO AP AQ AR AS AT AU AV AW AX AY AZ BA BB BC BD BE BF BG BH BI BJ BK BL BM BN BO BP BQ BR BS BT BU BV BW BX BY BZ CA CB CC CD CE CF CG CH CI CJ CK CL CM CN CO CP CQ CR CS CT CU CV CW CX CY CZ DA DB DC DE DF DG DH DI DJ DK DL DM DN DO DP DQ DR DS DT DU DV DW DX DY DZ EA EB EC ED EE EF EG EH EI EJ EK EL EM EN EO EP EQ ER ES ET EU EV EW EX EY EZ FA FB FC FD FE FF FG FH FI FJ FK FL FM FN FO FP FQ FR FS FT FU FV FW FX FY FZ GA GB GC GD GE GF GG GH GI GJ GK GL GM GN GO GP GQ GR GS GT GU GV GW GX GY GZ HA HB HC HD HE HF HG HH HI HJ HK HL HM HN HO HP HQ HR HS HT HU HV HW HX HY HZ IA IB IC ID IE IF IG IH II IJ IK IL IM IN IO IP IQ IR IS IT IU IV IW IX IY IZ JA JB JC JD JE JF JG JH JI JJ JK JL JM JN JO JP JQ JR JS JT JU JV JW JX JY JZ KA KB KC KD KE KF KG KH KI KJ KK KL KM KN KO KP KQ KR KS KT KU KV KW KX KY KZ LA LB LC LD LE LF LG LH LI LJ LK LL LM LN LO LP LQ LR LS LT LU LV LW LX LY LZ MA MB MC MD ME MF MG MH MI MJ MK ML MN MO MP MQ MR MS MT MU MV MW MX MY MZ NA NB NC ND NE NF NG NH NI NJ NK NL NO NP NQ NR NS NT NU NV NW NX NY NZ OA OB OC OD OE OF OG OH OI OJ OK OL OM ON OO OP OQ OR OS OT OU OV OW OX OY OZ PA PB PC PD PE PF PG PH PI PJ PK PL PM PN PO PP PQ PR PS PT PU PV PW PX PY PZ QA QB QC QD QE QF QG QH QI QJ QK QL QM QN QO QP QQ QR QS QT QU QV QW QX QY QZ RA RB RC RD RE RF RG RH RI RJ RK RL RM RN RO RP RQ RR RS RT RU RV RW RX RY RZ SA SB SC SD SE SF SG SH SI SJ SK SL SM SN SO SP SQ SR SS ST SU SV SW SX SY SZ TA TB TC TD TE TF TG TH TI TJ TK TL TM TN TO TP TQ TR TS TT TU TV TW TX TY TZ UA UB UC UD UE UF UG UH UI UJ UK UL UM UN UO UP UQ UR US UT UY UZ VA VB VC VD VE VF VG VH VI VJ VK VL VM VN VO VP VQ VR VS VT VY VZ WA WB WC WD WE WF WG WH WI WJ WK WL WM WN WO WP WQ WR WS WT WY WZ XA XB XC XD XE XF XG XH XI XJ XK XL XM XN XO XP XQ XR XS XT XU XV XW XX XY XZ YA YB YC YD YE YF YG YH YI YJ YK YL YM YN YO YP YQ YR YS YT YU YV YW YX YY YZ ZA ZB ZC ZD ZE ZF ZG ZH ZI ZJ ZK ZL ZM ZN ZO ZP ZQ ZR ZS ZT ZU ZV ZW ZX ZY ZZ

KYE

STAINLESS STEEL



für 11 Instrumente
for 11 instruments

KY 660/11



KY 660/50
284 x 183 mm



KY 660/51
48 x 27 x 9 mm

Lagerungstray
 Storing tray
 Tray para depositar
 Plateau pour déposer instruments
 Bacinella per il deposito degli strumenti

STAINLESS STEEL



180 x 60 x 22 mm
 für 5 Instrumente
 for 5 instruments
 para 5 instrumentos
 pour 5 instruments
 per 5 strumenti

KY 670/05

180 x 140 x 22 mm
 für 10 Instrumente
 for 10 instruments
 para 10 instrumentos
 pour 10 instruments
 per 10 strumenti

KY 670/10



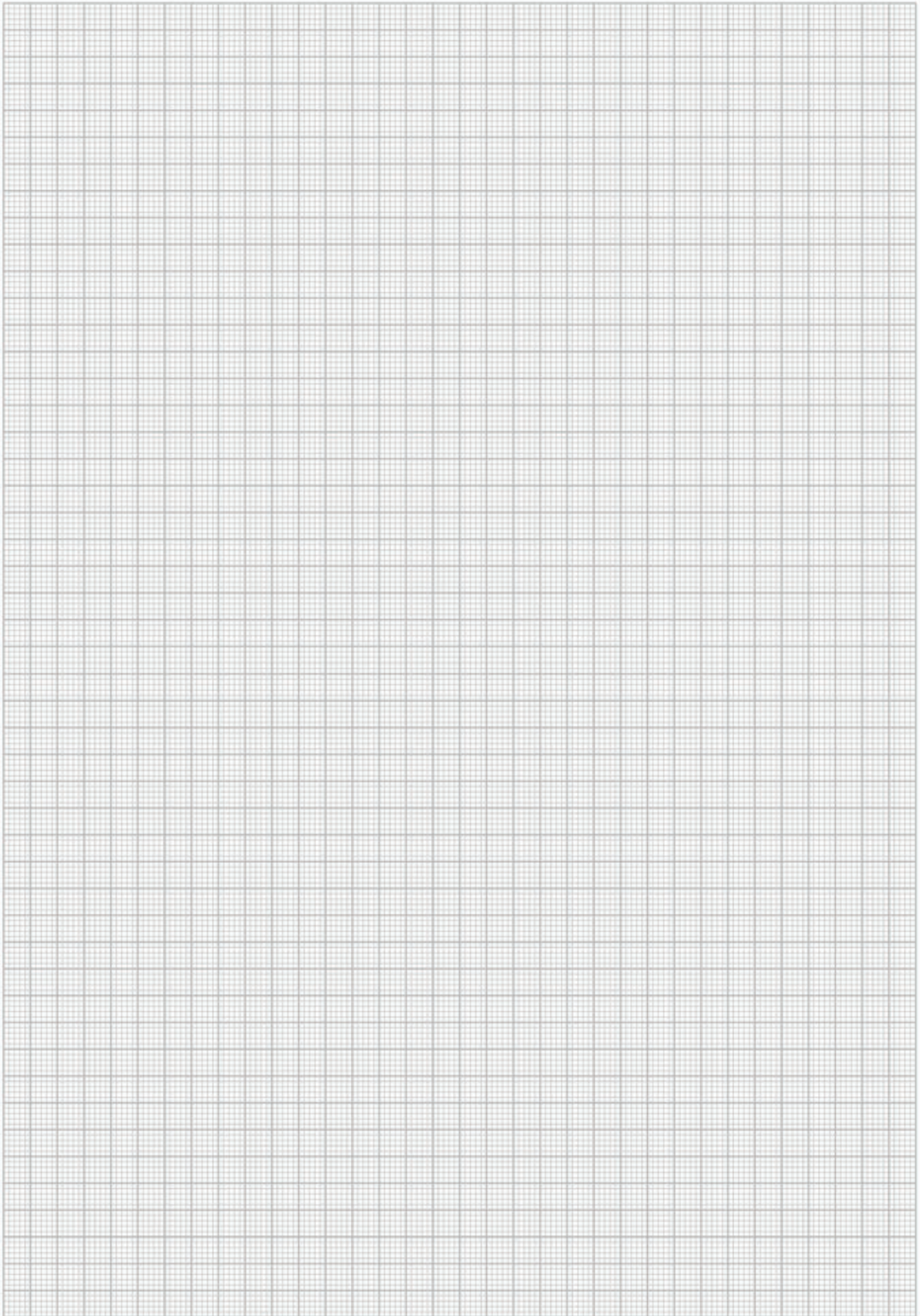

AA
 AB
 AC
 AD
 AE
 AF
 AG
 AH
 AI
 AJ
 AK
 AL
 AO
 AP
 AQ
 AR
 AS
 AT
 AU
 AV
 AW
 AX
 AY
 AZ
 BA
 BB
 BC
 BD
 BE
 BF
 BG
 BH
 BI
 BJ
 BK
 BL
 BM
 BN
 BO
 BP
 BQ
 BR
 BS
 BT
 BU
 BV
 BW
 BX
 BY
 BZ
 CA
 CB
 CC
 CD
 CE
 CF
 CG
 CH
 CI
 CJ
 CK
 CL
 CM
 CN
 CO
 CP
 CQ
 CR
 CS
 CT
 CU
 CV
 CW
 CX
 CY
 CZ
 DA
 DB
 DC
 DD
 DE
 DF
 DG
 DH
 DI
 DJ
 DK
 DL
 DM
 DN
 DO
 DP
 DQ
 DR
 DS
 DT
 DU
 DV
 DW
 DX
 DY
 DZ
 EA
 EB
 EC
 ED
 EE
 EF
 EG
 EH
 EI
 EJ
 EK
 EL
 EM
 EN
 EO
 EP
 EQ
 ER
 ES
 ET
 EU
 EV
 EW
 EX
 EY
 EZ
 FA
 FB
 FC
 FD
 FE
 FF
 FG
 FH
 FI
 FJ
 FK
 FL
 FM
 FN
 FO
 FP
 FQ
 FR
 FS
 FT
 FU
 FV
 FW
 FX
 FY
 FZ
 GA
 GB
 GC
 GD
 GE
 GF
 GG
 GH
 GI
 GJ
 GK
 GL
 GM
 GN
 GO
 GP
 GQ
 GR
 GS
 GT
 GU
 GV
 GW
 GX
 GY
 GZ
 HA
 HB
 HC
 HD
 HE
 HF
 HG
 HH
 HI
 HJ
 HK
 HL
 HM
 HN
 HO
 HP
 HQ
 HR
 HS
 HT
 HU
 HV
 HW
 HX
 HY
 HZ
 IA
 IB
 IC
 ID
 IE
 IF
 IG
 IH
 II
 IJ
 IK
 IL
 IM
 IN
 IO
 IP
 IQ
 IR
 IS
 IT
 IU
 IV
 IW
 IX
 IY
 IZ
 JA
 JB
 JC
 JD
 JE
 JF
 JG
 JH
 JI
 JJ
 JK
 JL
 JM
 JN
 JO
 JP
 JQ
 JR
 JS
 JT
 JU
 JV
 JW
 JX
 JY
 JZ
 KA
 KB
 KC
 KD
 KE
 KF
 KG
 KH
 KI
 KJ
 KK
 KL
 KM
 KN
 KO
 KP
 KQ
 KR
 KS
 KT
 KU
 KV
 KW
 KX
 KY
 KZ
 LA
 LB
 LC
 LD
 LE
 LF
 LG
 LH
 LI
 LJ
 LK
 LL
 LM
 LN
 LO
 LP
 LQ
 LR
 LS
 LT
 LU
 LV
 LW
 LX
 LY
 LZ
 MA
 MB
 MC
 MD
 ME
 MF
 MG
 MH
 MI
 MJ
 MK
 ML
 MM
 MN
 MO
 MP
 MQ
 MR
 MS
 MT
 MU
 MV
 MW
 MX
 MY
 MZ
 NA
 NB
 NC
 ND
 NE
 NF
 NG
 NH
 NI
 NJ
 NK
 NL
 NM
 NN
 NO
 NP
 NQ
 NR
 NS
 NT
 NU
 NV
 NW
 NX
 NY
 NZ
 OA
 OB
 OC
 OD
 OE
 OF
 OG
 OH
 OI
 OJ
 OK
 OL
 OM
 ON
 OO
 OP
 OQ
 OR
 OS
 OT
 OU
 OV
 OW
 OX
 OY
 OZ
 PA
 PB
 PC
 PD
 PE
 PF
 PG
 PH
 PI
 PJ
 PK
 PL
 PM
 PN
 PO
 PP
 PQ
 PR
 PS
 PT
 PU
 PV
 PW
 PX
 PY
 PZ
 QA
 QB
 QC
 QD
 QE
 QF
 QG
 QH
 QI
 QJ
 QK
 QL
 QM
 QN
 QO
 QP
 QQ
 QR
 QS
 QT
 QU
 QV
 QW
 QX
 QY
 QZ
 RA
 RB
 RC
 RD
 RE
 RF
 RG
 RH
 RI
 RJ
 RK
 RL
 RM
 RN
 RO
 RP
 RQ
 RR
 RS
 RT
 RU
 RV
 RW
 RX
 RY
 RZ
 SA
 SB
 SC
 SD
 SE
 SF
 SG
 SH
 SI
 SJ
 SK
 SL
 SM
 SN
 SO
 SP
 SQ
 SR
 SS
 ST
 SU
 SV
 SW
 SX
 SY
 SZ
 TA
 TB
 TC
 TD
 TE
 TF
 TG
 TH
 TI
 TJ
 TK
 TL
 TM
 TN
 TO
 TP
 TQ
 TR
 TS
 TT
 TU
 TV
 TW
 TX
 TY
 TZ
 UA
 UB
 UC
 UD
 UE
 UF
 UG
 UH
 UI
 UJ
 UK
 UL
 UM
 UN
 UO
 UP
 UQ
 UR
 US
 UT
 UY
 UZ
 VA
 VB
 VC
 VD
 VE
 VF
 VG
 VH
 VI
 VJ
 VK
 VL
 VM
 VN
 VO
 VP
 VQ
 VR
 VS
 VT
 VU
 VV
 VW
 VX
 VY
 VZ
 WA
 WB
 WC
 WD
 WE
 WF
 WG
 WH
 WI
 WJ
 WK
 WL
 WM
 WN
 WO
 WP
 WQ
 WR
 WS
 WT
 WU
 WV
 WW
 WX
 WY
 WZ
 XA
 XB
 XC
 XD
 XE
 XF
 XG
 XH
 XI
 XJ
 XK
 XL
 XM
 XN
 XO
 XP
 XQ
 XR
 XS
 XT
 XU
 XV
 XW
 XX
 XY
 XZ
 YA
 YB
 YC
 YD
 YE
 YF
 YG
 YH
 YI
 YJ
 YK
 YL
 YM
 YN
 YO
 YP
 YQ
 YR
 YS
 YT
 YU
 YV
 YW
 YX
 YZ
 ZA
 ZB
 ZC
 ZD
 ZE
 ZF
 ZG
 ZH
 ZI
 ZJ
 ZK
 ZL
 ZM
 ZN
 ZO
 ZP
 ZQ
 ZR
 ZS
 ZT
 ZU
 ZV
 ZW
 ZX
 ZY
 ZZ

KYE



STERILISATION STERILIZATION ESTERILIZACION STERILISATION STERILIZZAZIONE

Siebkörbe aus Lochblech
 Perforated steel basket
 Cestillo de acero perforado
 Panier d'acier poinçonné
 Cestello in acciaio perforato

	h mm	 box and lid	 box	 lid
 265 x 125 x h	50	SU 450/05	SU 450/55	SU 450/65
 275 x 175 x h	40 95	SU 451/04 SU 451/09	SU 451/54 SU 451/59	SU 451/65

AA
AB
AC
AD
AE
AF
AK
AL
AO
AR
KA
KL
KU
PA
PB
PF
PI
PK
PL
PM
PP
PS
PT
PU
PV

KYE

Inhaltsverzeichnis

	Seite		Seite
A		CASTROVIEJO , Mikronadelhalter	83
Abdrucklöffel	327-330	CASTROVIEJO , Mikronadelhalter mit Hartmetall, TUC	80
Abdrucklöffel für partielle Abdrücke	331-332	CASTROVIEJO , Zirkel	117
ADAMS , Distalschneider, Drahtbiegezeuge	319	CHADWICK , Augenschere	45
ADAMS , Serviettenhalter	157	CHEATLE , Sterilisierklammern	157
ADERER , Bandentfernungsangen	319	Chirurgische Scheren	36-38
ADERER , Drahtbiegeangen	321	CHOMPRET , Wurzelheber	244
ADERER , Klammerbiegezeuge	320	CLEVELAND , Hohlmeisselzangen	131
ADSON , Hartmetallpinzetten TUC	28	CLEVELAND , Knochensplitterzangen	136
ADSON , Pinzetten	20, 21	CLEVELAND-GARDNER , Knochensplitterzangen	136
ADSON-BABY , Arterienklemmen	13	COAKLEY , Trokare	105
ADSON-BROWN , Pinzetten	21	COGSWELL , Saugrohre	107
ADSON-MICRO , Pinzetten	20	COLEMAN , Wurzelheber	232
ADSON-TOENNIS-DELICATE , Hartmetallschere TUC	57	COLLEGE-LONDON , Zahnpinzetten	29
AINSWORTH , Kofferdam-Lochzange	338	COLLER , Arterienklemmen	10
ALEXANDER , Meißel	122	COLLIER , Nadelhalter	66
Amalgaminstrumente	299	COLLIN , Hämmer	125
Amalgampistole	299	COLLIN , Zungenzangen	148
Ampullenspritzen	109	COLUMBIA , Küretten	255
ANGLE , Drahtbiegeangen	319, 321	CONVERSE , Hartmetallnadelhalter TUC	74
Anmischbecher	158	CONVERSE-DERF , Nadelhalter	66
Anmischplatten-Glas	159	CORWIN , Drahtzangen	312
APICAL , Wurzelheber	229, 230	CORWIN , Hartmetalldrahtzangen TUC	79
Applikationsspritzen	341	COUPLAND , Saugrohre	106, 108
ARRUGA , Hartmetallnadelhalter TUC	77	COUPLAND , Wurzelheber	233
ARRUGA , Nadelhalter	66	CRANE-KAPLAN , Markierungspinetten	32
Arterienklemmen	8, 9-13	CRILE , Arterienklemmen	11
Artikulationspapierpinzetten	32	CRILE-RANKIN , Arterienklemmen	11
		CRILE-WOOD , Hartmetallnadelhalter TUC	75
B		CRILE-WOOD , Nadelhalter	68
BABY-ADSON , Arterienklemmen	13	CRILE-WOOD-BABY , Hartmetallnadelhalter TUC	75
BABY-CRILE-WOOD , Hartmetallnadelhalter TUC	75	CRILE-WOOD-BABY , Nadelhalter	68
BABY-CRILE-WOOD , Nadelhalter	68	CROWN-REMOVER , Kroneninstrumente	310
BABY-METZENBAUM , Präparierschere	39	CRUYER , Wurzelheber	228
BACKHAUS , Tuchklemmen	14	CRUYER , Zahnzangen, amerik. Modelle	218, 220, 221
BALL & SOCKET , Tuchklemmen	15	CUMINE , Zahnreiniger	251
Bandentfernungsangen	319	CUSHING , Hartmetallpinzetten TUC	28
Bandtreiber	309	CUSHING , Pinzetten	23
BEALE , Wachs-, Porzellan- und Modellierinstrumente	306	CUSHING-TAYLOR , Hartmetallpinzetten TUC	28
BEEBEE , Kronenschere	47, 48	D	
BEIN , Wurzelheber	237	DAVIS-BOYLE , Mundsperrerr	143
BENNET , Füllungsinstrumente	298	DE BAKEY , Atraumatische Pinzetten	26
BEYER , Hohlmeisselzangen	133	DE BAKEY , Hartmetallnadelhalter TUC	73
BLACK , Schmelzmeißel	283	DEAN , Hartmetallschere TUC	58
BLUMENTHAL , Hohlmeisselzangen	132	DEAN , Zahnfleischschere	49
BÖHLER , Hohlmeisselzangen	133	DEAN-DELICATE , Zahnfleischschere	49
BÖHM , Teleskopkronenzangen	325	DENHART , Mundsperrerr	141
BOLEY , Schieblehre	115	DERF , Hartmetallnadelhalter TUC	74
BOYNTON , Hartmetallnadelhalter TUC	77	DERBY-PERRY , Exkavatoren	280
BOYNTON , Nadelhalter	66	DERF , Nadelhalter	66
BREWER , Kofferdam-Klammerzange	338	DERF-CONVERSE , Nadelhalter	66
BRODIE , Sonden	104	DESMARRES , feine Wundhaken	93
BROPHY-SULLIVAN , feine Schere	43	DINGMANN , Mundsperrerr	143
BROWN-ADSON , Pinzetten	21	Dissektoren	148
BRUENINGS , Zungendrucker	147	Distalschneider	319
BRUNS , scharfe Löffel	127	DOUGLAS , Trokare	105
Bruststütze für Mundsperrerr	144	DOYEN , Nadelhalter	66
Bügelbiegeangen	315, 316	DOYEN , Sonden	103
BYRD , Saugrohre	106	Drahtbiegeangen	319, 321
		Drahtschere	47
C		Drahtzangen	311-314
Caliper	114, 115	Drahtzangen mit Hartmetalleinsätzen TUC	79
CARREL , Arterienklemme	8	DUMONT , Rund-, Flachzangen	322
CARROLL , Nadelhalter	68	E	
CASTROVIEJO-EPKER , Zirkel	118	EISELSBERG , Ligaturschere	46
CASTROVIEJO , Hartmetallmikronadelhalter TUC	80	ENGLISCHES MODELL , Tuchklemmen	14
CASTROVIEJO , Hornhautschere	51	EWALD , Pinzetten	21
CASTROVIEJO , Iridektomieschere	51		

	Seite		Seite
Exkavatoren	275-280	HOW , Ligaturzangen	318
F		HYGIENIST , Zahnreiniger	252
FAHNENSTOCK , Wachsmesser	308	HYLIN , Wachs-, Porzellan- und Modellierinstrumente	306
FARABEUF , Wundhaken	99	HYLIN , Wurzelheber	236
FARRELL , Watteträger	104	I	
Feine Wundhaken	90-93	Implantat-Messzangen	344
FELT , Kompositinstrumente	302	Implantologie	339-346
Fingerschützer	140	Instrumente, Mess-	111-118
Flach-, Rundzangen	322-324	Instrumentenablageplatten	155
Flachzangen	313	Iridektomiescheren	51
FLAGG , Zahnpinzetten	30	IVORY , Amalgampistole	299
FLOHR , Wurzelheber	227	IVORY , Kofferdam-Klammerzange	338
FOX-GOLDMAN SPEZIAL , Zahnfleissscheren	49	IVORY , Matrizenspanner	335, 336
FOX-GOLDMAN , Zahnfleissscheren	49	IWANSON , Federlehren	116
FRAHM , Wachs-, Porzellan- und Modellierinstrumente	305	J	
FRAZIER , Saugrohre	106	JACOBSON , Hartmetallmikronadelhalter TUC	80
FRENZEL , Zungendrucker	147	JACOBSON , Mikronadelhalter	83
FRIEDMAN , Hohlmeisselzangen	131	JAMESON , Schieblehre	114
FRIEDMAN , Wurzelheber	234	JANSEN , scharfe Löffel	128
Füllungsinstrumente	285-302	JENNINGS , Mundsperrer	141
G		JEWELER , Hartmetallpinzetten TUC	27
GERALD , Pinzetten	23	JONES , Tuchklemmen	14
GILLIES , Hartmetallnadelhalter TUC	76	JOSEPH , feine Wundhaken	91
GILLIES , Hartmetallpinzetten TUC	27	JOSEPH , Präparierscheren	42
GILLIES , Nadelhalter	69	K	
Gingivektomiemesser	260, 261	Kanülen	103, 104
Gipsmesser	308	KAPLAN-CRANE , Markierungspinzetten	32
Glas-Anmischplatten	159	KAYE , Face-Lift-Scheren TUC	57
GOLDMAN-FOX SPEZIAL , Zahnfleissscheren	49	Keilbeinstanzen	137
GOLDMAN-FOX , Gingivektomiemesser	260	KELLS , Zahnzangen, amerik. Modelle	222
GOLDMAN-FOX , Hartmetallscheren TUC	57	KELLY , Arterienklemmen	10
GOLDMAN-FOX , Scaler	259	KELLY , Hartmetallscheren TUC	54
GOLDMAN-FOX , Zahnfleissscheren	49	KELLY , Scheren	38
GOLDSTEIN , Kompositinstrumente	302	KELLY-RANKIN , Arterienklemmen	10
GOSLEE , Rund-, Flachzangen	324	KERRISON , Keilbeinstanzen	137
GRACEY STANDARD , Küretten	256	KILNER , Hartmetallnadelhalter TUC	74
GRAEFE , Augenscheren	45	KILNER , Nadelhalter	67
GRAZIL , Chirurgische Scheren	37	KILNER-DOUGHTY , Mundsperrer	142
GREEN-SENN , feine Wundhaken	92	KILNER-RAGNELL , Präparierscheren	42
GRITMANN , Gipsmesser	308	Kinderzahnzangen, amerik. Modelle	223, 224
GROSS-MAIER , Kornzangen	87	Kinderzahnzangen, englische Modelle	195-202
GUTHRIE , feine Wundhaken	91	KIRKLAND , Gingivektomiemesser	261
H		Klammerbiegezangen	320
HAJEK , Hämmer	125	Klammerzange-Kofferdam	338
HAJEK-KOFLER , Keilbeinstanzen	137	KLEIN , Kinderzahnzangen engl. Modelle	199, 201, 202
Haken, Wund-	89-100	KLEINERT-KUTZ , Hohlmeisselzangen	133
HALSEY , Hartmetallnadelhalter TUC	74	Klemmen	7, 8-16
HALSEY , Nadelhalter	67	Klemmen, Arterien-	8, 9-13
HALSTED , Arterienklemmen	10	Klemmen, Tuch-	14, 15
HALSTED-MOSQUITO , Arterienklemmen	9	KNAPP , feine Wundhaken	91
Hämmer	125, 126	Knochenfeilen	265-267
HARRIS , Zahnzangen, amerik. Modelle	212	Knocheninstrumente	119-138
HARTMANN , Arterienklemmen	8	Knochenmühle	345
HARTMANN , Zungendrucker	146	Knochensplitterzangen	136
HARVEY , Drahtscheren	47	Knochenspritzen	342, 343
HEGAR-OLSEN , Hartmetallnadelhalter TUC	75	KOCHER-DELICATE , Arterienklemmen	13
HEGAR-OLSEN , Nadelhalter	69	KOCHER-LANGENBECK , Wundhaken	98
HEGAR-OLSEN-USA , Hartmetallnadelhalter TUC	75	KOCHER-OCHSNER , Arterienklemmen	12
HEIDEBRINK , Wurzelheber	245, 247	Kofferdam-Klammerzange	338
HEIDEMANN , Füllungsinstrumente	291	Kofferdam-Lochzange	338
HEISTER , Mundsperrer	140	Kompositinstrumente	302
HEMINGWAY , scharfe Löffel	129	Kornzangen	87, 88
HENAHAN , Weisheitszahnhaken	138	KRAUSE , Trokare	105
HILGER , Mundspiegelansätze	150	KROENIG , Zungendrucker	147
Hohlmeisselzangen	131-135	Kronenabnehmer	309
HOKE , Osteotome	121	Kronenaufbieger	309
HOLLENBACK , Füllungsinstrumente	287	Kroneninstrumente	309, 310
HOLLENBACK , Wachs-, Porzellan- und Modellierinstrumente	305	Kronenscheren	47, 48
HOLLOW-CHOP , Rund-, Flachzangen	322	Kugel/Spatel-Kombination	296

	Seite		Seite
Kugelstopfer	295	Messbecher	153
Kunststoffansatz	299	Messinstrumente	111-118
Küretten	255, 256	METZENBAUM , Hartmetallnadelhalter TUC	77
L		METZENBAUM , Hartmetallscheren TUC	55
LA GRANGE , Augenscheren	45	METZENBAUM , Präparierscheren	39
Lagerungstray	361	METZENBAUM-BABY , Präparierscheren	39
LANDGRAF , Zahnpinzetten	31	METZENBAUM-DELICATE , Hartmetallscheren TUC	56
LANGENBECK , Fingerschützer	140	METZENBAUM-DELICATE , Präparierscheren	41
LANGENBECK , Hartmetallnadelhalter TUC	78	METZENBAUM-NELSON , Präparierscheren	40
LANGENBECK , Nadelhalter	70	MEYERDING , feine Wundhaken	92
LANGENBECK , Wundhaken	97	MICRO-ADSON , Pinzetten	20
LANGENBECK-DELICATE , Hartmetallnadelhalter TUC	78	MICRO-FRIEDMANN , Hohlmeisselzangen	135
LANGENBECK-KOCHER , Wundhaken	98	MICRO-MOSQUITO , Arterienklemmen	9
LANGENBECK-MINI , feine Wundhaken	92	MIDDELDORPF , Wundhaken	99
LANGENBECK-RYDER , Hartmetallnadelhalter TUC	78	Mikronadelhalter	81-83
LAWRENCE-READ , Zahnzange englisches Modell	179	Mikronadelhalter mit Rundgriff	81, 82
LE CRON , Wachs-, Porzellan- und Modellierinstrumente	306	Mikroscheren	51, 52
LECLUSE , Wurzelheber	240	MILLER , Artikulationspapierpinzette	32
LICHTENBERG , Hartmetallnadelhalter TUC	77	MILLER-APEXO , Wurzelheber	235
LICHTENSTEIN , Gipsmesser	308	MILLER-COLBURN , Knochenfeilen	265, 266
LICHTWITZ , Trokare	105	MINI , Skalpellgriffe	62
Ligaturscheren	46	MINI , Skalpellklingen	62
Ligaturzangen	318	MINI-FRIEDMAN , Hohlmeisselzangen	131
LINDO LEVIAN , Wurzelheber	235	MINI-LANGENBECK , feine Wundhaken	92
Lippen- und Wangenhalter	146, 147	MINI-LEXER , Meißel	124
LISTER , Hartmetallscheren TUC	58	MINI-LEXER , Osteotome	124
LISTER , Tupferzangen	87	MITCHELL , Zahnreiniger	251
LITTAUER , Ligaturscheren	46	MOD.WÜRZBURG , Mundsperrerr	144
LITTAUER-LISTON , Knochensplitterzangen	136	MOLT , Mundsperrerr	140
Lochzange-Kofferdam	338	MOLT , Raspatorien	130, 263
LOCKHART-MUMMERY , Sonden	104	MORITZ-SCHMIDT , Zungendrucker	146
LOCKLIN , Hartmetallscheren TUC	58	MOSQUITO-HALSTED , Arterienklemmen	9
LOCKLIN , Zahnfleischscheren	49	MOSQUITO-MICRO , Arterienklemmen	9
LONDON-COLLEGE , Zahnpinzetten	29	MUMMERY-LOCKHART , Sonden	104
LORNA , Tuchklemme	15	Mund / Zunge	139-150
LOTH-SCHOEMAKER , Ligaturscheren	46	Mundkeile	140, 145
LUCAE , Hämmer	126	Mundsperrerr	140-144
LUCAS , Meißel	121	Mundspiegelansätze	150
LUCAS , scharfe Löffel	129	Mundspiegelgriffe	149
LUER , Hohlmeisselzangen	132	MYRTLE-LEAF , Sonden	103
LUER , Saugrohre	107	N	
LUNIATSCHECK , Dissektoren	148	Nadelhalter	66-70
M		Nadelhalter, Hartmetall TUC-	73-78
Markierungspinzetten	32	Nadelhalter, Mikro-	81-83
MARTINI , scharfe Löffel	128	Nadel-Sterilisierkästen	154
MATHIEU , Hartmetallnadelhalter TUC	76	Naht	65-84
MATHIEU , Nadelhalter	69	Nahtpinzetten	31
MATHIEU-DELICATE , Hartmetallnadelhalter TUC	76	NANCE , Distalschneider, Drahtbiegezeuge	319
MATHIEU-DELICATE , Nadelhalter	69	NANCE , Klammerbiegezeuge	320
Matrizen	333-338	NEGUS , Bruststütze für Mundsperrerr	144
Matrizen und Matrizenspanner	335-337	NEIVERT , Hartmetallnadelhalter TUC	74
MAUNDER , Mundkeile	140	NEIVERT , Nadelhalter	67
MAYFIELD , Hohlmeisselzangen	132	NELATON , Sonden	103
MAYO , Scheren	38	NELSON-METZENBAUM , Präparierscheren	40
MAYO , Sterilisierklammern	157	NEUMANN , Zahnfleischscheren	50
MAYO , Zungendrucker	147	NEVIUS , Zahnzangen, amerik. Modelle	217
MAYO-HEGAR , Hartmetallnadelhalter TUC	73	Nierenschalen	153
MAYO-HEGAR , Nadelhalter	68	Norm-Trays und Zubehör	353- 362
MAYO-HEGAR-DELICATE , Hartmetallnadelhalter TUC	73	NOYES , Iridektomiescheren	51
MAYO-HEGAR-DELICATE , Nadelhalter	68	O	
MC INDOE , Pinzetten	21	OBWEGESER , Ramushaken	96
MC IVOR , Mundsperrerr	144	OBWEGESER , Weichteilhaken	94, 95
McCALL , Küretten	255	OCHSENBEIN , Paradontalmeißel	262
McCALL , Zahnreiniger	251	OCHSNER-KOCHER , Arterienklemmen	12
McKESSON , Mundkeile	145	OEHLER , Hartmetallpinzetten TUC	27
MEAD , Hämmer	126	OHL , Raspatorien	264
MEAD , Hohlmeisselzangen	132	OLSEN-HEGAR , Hartmetallnadelhalter TUC	75
MEAD , Zahnzangen engl. Modelle	186	OLSEN-HEGAR , Nadelhalter	69
Meißel	121-124	OLSEN-HEGAR-USA , Hartmetallnadelhalter TUC	75
MERIAM , Zahnpinzetten	30	OMS , Paradontometer	274
MERSHON , Bandtreiber	309	ORBAN , Gingivektomiemesser	261

	Seite		Seite
Osteotome	121-124	Scheren, Hartmetall TUC	54-58
P		Scheren, Iridektomie-	51
Paradontalmeißel	262	Scheren, Kronen-	47, 48
Paradontologie	253-268	Scheren, Ligatur-	46
Paradontometer	274	Scheren, Mikro-	51, 52
PARKER , Wundhaken	99	Scheren, Präparier-	39-42
PARKER , Wundhaken	99	Scheren, Strabismus-	45
PARMILY , Zahnzangen, amerik. Modelle	214	Scheren, Supercut SC	35
PARTSCH , Hämmer	126	Scheren, Zahnfleisch-	49, 50
PARTSCH , Meißel	123	Schmelzmeißel	281-284
PEAN , Fasszangen	8	SCHOEMAKER-LOTH , Ligaturscheren	46
PEAN-DELICATE , Arterienklemmen	13	SCHUKNECHT , Drahtscheren	47
PEAN-ROCHESTER , Arterienklemmen	11	Schwammzangen	87
PEERS , Tuchklemmen	15	SCHWARZ , Bügelbiegezangen	315
PEET , Splitterpinzetten	25	SCHWARZ , Drahtbiegezangen	321
PERRY , Zahnpinzetten	31	SCHWARZ , Klammerbiegezangen	320
PIERCE , Trokare	105	SECCO , Mundspiegelgriffe	149
Pinzetten	17-32	SEEMANN-SEIFFERT , Mundsperrer	141
Pinzetten, anatomisch	19-23	Sehnenscheren	45
Pinzetten, Artikulationspapier-	32	SELDIN , Raspatorien	263
Pinzetten, chirurgisch	19-23	SELDIN , Wurzelheber	231
Pinzetten, Hartmetall TUC	27, 28	SEMKEN , Hartmetallpinzetten TUC	27
Pinzetten, Markierungs-	32	SEMKEN , Pinzetten	21, 22
Pinzetten, Naht-	31	SENN-GREEN , feine Wundhaken	92
Pinzetten, Splitter-	24, 25	Serviettenhalter	157
Pinzetten, Zahn-	29-31	Siebkörbe aus Lochblech	362
PITHA , Mundkeile	140	SILVER-POINT , Zange	25
Planstopfer	289	SIMPLEX , Wangenhalter	146
POTT , Wurzelheber	241	Skalpelle	59-64
POTTS-SMITH , Hartmetallpinzetten TUC	27	Skalpellgriffe	61, 62
Präparierscheren	39-42	Skalpellslingen	62, 63
PRATT , Fistelsonden	104	SMITH , Drahtscheren	47
PRICHARD , Raspatorien	263	SMITH-POTTS , Hartmetallpinzetten TUC	27
Prothetik und Orthodontie	303-332	Sonden	103, 104
PYE-SMITH (HARRISON) , Sterilisierklammern	157	Sonden	269-274
Q		Sonden und Kanülen	101-110
QUINBY , Zahnfleischscheren	50	Spatel	297
R		SPENCER , Ligaturscheren	46
RAGNELL-KILNER , Präparierscheren	42	SPENCER-DELICATE , Ligaturscheren	46
RALK , Splitterpinzetten	25	Splitterpinzetten	24, 25
Ramushaken	96	SPRATT , scharfe Löffel	127
RANKIN-CRILE , Arterienklemmen	11	Spreizer	273
RANKIN-KELLY , Arterienklemmen	10	STACKE , Sonden	103
Raspatorien	130, 263, 264	STANDARD , anatomische Pinzetten	19
REILL , Mikronadelhalter	81	STANDARD , chirurgische Pinzetten	19
REYNOLDS , Präparierscheren	42	STANDARD , chirurgische Scheren	36
ROCHESTER-PEAN , Arterienklemmen	11	STANDARD , Pinzetten	19
ROEDER , Tuchklemmen	15	STANDARD , Zahnfleischscheren	50
ROGGE , Sterilisierklammern	157	STANDARD , Zungendrücker	147
ROLLET , feine Wundhaken	91	STELLBRINK , Hohlmeisselzangen	131
ROSER-KÖNIG , Mundsperrer	141	Sterilisationsbehältnisse und Norm-Trays	347- 362
ROUX , Wundhaken	99	Sterilisierklammern	157
Rund-, Flachzangen	322-324	STERNBERG , Wangen- und Lippenhalter	146
RUSKIN , Hohlmeisselzangen	134	STERNUM , Drahtzangen	312
RUSKIN-MINI , Hohlmeisselzangen	133	STERNUM , Hartmetalldrahtzangen TUC	79
S		STEVENS , Hartmetallscheren TUC	57
SANVENERO , Präparierscheren	42	STEVENS , Sehnenscheren	45
Saugrohre	106-108	STIEGLITZ , Splitterpinzetten	25
Scaler	259	STOCKES , Kofferdam-Klammerzangen	338
SCHAEDEL , Tuchklemmen	14	Strabismusscheren	45
Schalen	153, 155, 156	SULLIVAN , Zahnfleischscheren	50
Scharfe Löffel	127-129	SULLIVAN-BROPHY , feine Scheren	43
SCHUDE , scharfe Löffel	127	Super Cut Scheren	35
Scheren	33-58	T	
Scheren, Chirurgische-	36-38	TAYLOR , Pinzetten	22
Scheren, Draht-	47	TAYLOR-CUSHING , Hartmetallpinzetten TUC	28
Scheren, fein	43-45	Teleskopkronenzangen	325
		TERRIER , Arterienklemmen	8
		THIESS , Hämmer	126
		THOMAS , Wachs-, Porzellan- und Modellierinstrumente	307
		TOBOLD , Zungendrücker	146
		TOENNIS , Hartmetallnadelhalter TUC	77
		TOENNIS , Nadelhalter	70

	Seite		Seite
TOENNIS-ADSON-DELICATE , Hartmetallscheren TUC	57	YOUNG , Drahtbiegezangen	321
TOFFLEMIRE- UNIVERSAL , Matrizenspanner	337	YOUNG , Zungenzangen	148
TOFFLEMIRE , Matrizen	337	YOUNGER-GOOD , Zahnreiniger	251
TOHOKU-JAPAN , Tuchklemmen	15		
TOMES , Zahnzangen, amerik. Modelle	216	Z	
TOWNER , Zahnreiniger	251	ZAHLE , Wachs-, Porzellan- und Modellierinstrumente	306
TOWNLEY , Schieblehre	114	Zahnfleischmesser	64
Trepanbohrer	344	Zahnfleischscheren	49, 50
TREYMANN , Kronenabnehmer	309	Zahnpinzetten	29-31
Trokare	105	Zahnreiniger	249-252
Tuchklemmen	14, 15	Zahnsonden	271, 272
Tupferzangen	85-88	Zahnzangen, amerikanische Modelle	205-224
		Zahnzangen, Elegance	187-194
U		Zahnzangen, englische Modelle	161-204
UNIV.MINNESOTA , Zungendrucker	147	Zangen, Draht- mit Hartmetalleinsätzen TUC	79
UNIVERSAL , Drahtscheren	47	Zangen, Korn-	87, 88
UNIVERSAL , Hartmetallscheren TUC	58	Zangen, Schwamm-	87
UNIVERSAL , Hohlmeisselzangen	131	Zangen, Tupfer-	85-88
UNIVERSAL , Universalzangen	317	ZAUFAL-JANSEN , Hohlmeisselzangen	134
Universalzangen	317	Zementspatel	300, 301
USA , Füllungsinstrumente	291	Zungendrucker	146, 147
USA , Kofferdam-Lochzangen	338	Zungenzangen	148
		Zwickzangen	316
V			
VERNIER , Caliper	114, 115		
Verschiedenes	151-160		
VOLKMANN , scharfe Löffel	127		
W			
W.F. BARRY , Wurzelheber	242		
Wachs-, Porzellan- und Modellierinstrumente	305-308		
Wachsmesser	308		
WAGNER , feine Scheren	43		
WALDSACHS , Universalzangen	317		
WALTON , Kornzangen	88		
Wangen- und Lippenhalter	146, 147		
WARD , Wachs-, Porzellan- und Modellierinstrumente	305		
WARWICK-JAMES , Wurzelheber	241		
Wattespender	158		
Watteträger	104		
WEBSTER , Hartmetallnadelhalter TUC	74		
WEBSTER , Nadelhalter	67		
WECKER , Iridektomiescheren	51		
WEDELSTAEDT , Schmelzmeißel	284		
Weichteilhaken	94, 95		
WEINGART , Ligaturzangen	318		
Weisheitszahnhaken	138		
WEST , Raspatorien	264		
WEST , Wurzelheber	248		
WESTCOTT , Mikroscheren	52		
WESTCOTT , Sehnenscheren	52		
WHITE , Exkavatoren	278		
WHITEHEAD , Mundsperrer	142		
WHO , Paradontometer	274		
WIEDER , Zungendrucker	146		
WILLIGER , Raspatorien	130		
WILLIGER , scharfe Löffel	128		
WILMER , Augenscheren	45		
WINTER , Wurzelheber	243		
Wipphahn-Brenner	159		
WITZEL , Wurzelsplitterzangen	203		
WOODSON , Füllungsinstrumente	292		
WOODWARD , Zahnzangen, amerik. Modelle	209		
Wundhaken	89-100		
Wundhaken, fein	90-93		
Wurzelheber	225-248		
Wurzelkanalstopfer	273		
Wurzelsplitterzangen	203		
WYNMAN , Kronen Zange	310		
Y			

Index

	Page		Page
A			
ADAMS , distal cutter, wire bending pliers	319	Cartridge syringes	109
ADAMS , napkin holder	157	CASTROVIEJO , circle	117
ADERER , clasp bending pliers	320	CASTROVIEJO , corneal scissors	51
ADERER , distal cutter, wire bending pliers	319, 321	CASTROVIEJO , micro needle holders	83
ADSON , dissecting forceps tungsten TUC	28	CASTROVIEJO , micro needle holders tungsten TUC	80
ADSON , dressing and tissue forceps	20, 21	CASTROVIEJO-EPKER , circle	118
ADSON-BABY , dissecting and ligature forceps	13	Cement mixing spatula	300, 301
ADSON-MICRO , dressing and tissue forceps	20	CHADWICK , eye scissors	45
ADSON-TOENNIS-DELICATE , scissors tungsten TUC	57	CHEATLE , safety pins	157
AINSWORTH , punch forceps	338	Cheek and lip retractors	146, 147
ALEXANDER , chisels	122	Chest support for mouth gag	144
Amalgam carrier	299	Chisels	121-124
Amalgam instruments	299	Chisels, Gouges and Osteotomes	121-124
ANGLE , distal cutter, wire bending pliers	319, 321	CHOMPRET , root elevators	244
APICAL , root elevators	229, 230	Clamp forceps	338
Application syringe	341	Clasp bending pliers	320
Applicators, cotton	104	CLEVELAND , bone cutting forceps	136
ARRUGA , needle holder	66	CLEVELAND , bone rongeurs	131
ARRUGA , needle holder tungsten TUC	77	CLEVELAND-GARDNER , bone cutting forceps	136
Artery forceps	8, 9-13	COAKLEY , trocars	105
Artery forceps, delicate	13	COGSWELL , suction tubes	107
Articulating paper forceps	32	COLEMAN , root elevators	232
B			
BABY-ADSON , ligature and dissecting forceps	13	COLLER , artery forceps	10
BABY-CRILE-WOOD , needle holders	68	COLLIER , needle holders	66
BABY-CRILE-WOOD , needle holders tungsten TUC	75	COLLIN , mallets	125
BABY-METZENBAUM , scissors	39	COLLIN , tongue holding forceps	148
BACKHAUS , towel forceps	14	COLUMBIA , curettes	255
BALL & SOCKET , towel forceps	15	Composite instruments	302
Ball/spatula combination	296	CONVERSE , needle holders tungsten TUC	74
Ball-type condenser	295	CONVERSE-DERF , needle holders	66
Band pusher	309	CORWIN , wire forceps	312
Bar bending pliers	315, 316	CORWIN , wire twisting forceps tungsten TUC	79
BEALE , wax, porcelain and modelling carvers	306	Cotton and dressing pliers	29-31
BEEBEE , crown scissors	47, 48	Cotton applicators	104
BEIN , root elevators	237	Cotton dispenser	158
BENNET , filling instruments	298	COUPLAND , root elevators	233
BEYER , bone rongeurs	133	COUPLAND , suction tubes	106, 108
BLACK , enamel chisels	283	CRANE-KAPLAN , pocket markers	32
BLUMENTHAL , bone rongeurs	132	CRILE , artery forceps	11
BÖHLER , bone rongeurs	133	CRILE-RANKIN , artery forceps	11
BÖHM , telescopic crown pliers	325	CRILE-WOOD , needle holders	68
BOLEY , caliper	115	CRILE-WOOD , needle holders tungsten TUC	75
Bone carriers	342, 343	CRILE-WOOD-BABY , needle holders	68
Bone curettes	127-129	Crown remover	309
Bone curettes	127-129	Crown scissors	47, 48
Bone cutting forceps	136	Crown spreader	309
Bone files	265-267	CROWN-REMOVER , instruments for crown work	310
Bone instruments	119-138	CRYER , extracting forceps, american pattern	218, 220, 221
Bone mill	345	CRYER , root elevators	228
Bone rongeurs	131-135	CUMINE , dental scalers	251
Bowls	153, 155, 156	Curettes	255-258
BOYNTON , needle holders	66	CUSHING , dissecting forceps tungsten TUC	28
BOYNTON , needle holders tungsten TUC	77	CUSHING , dressing and tissue forceps	23
BREWER , clamp forceps	338	CUSHING-TAYLOR , dissecting forceps tungsten TUC	28
BRODIE , probes	104	D	
BROPHY(SULLIVAN) , fine scissors	43	Dappen dish	158
BROWN-ADSON , dressing forceps	21	DAVIS-BOYLE , mouth gags	143
BRUENINGS , tongue depressors	147	DE BAKEY(MAYO-HEGAR-DELICATE) , needle holders TUC	73
BRUNS , bone curettes	127	DE BAKEY , non-traumatic tissue forceps	26
BYRD , suction tubes	106	DEAN , gum scissors	49
C			
Caliper	114, 115	DEAN , scissors tungsten TUC	58
CARREL , artery forceps	8	DEAN-DELICATE , gum scissors	49
CARROLL , needle holders	68	Delicate artery forceps	13
		Delicate hooks	90-93
		DENHART , mouth gags	141
		Dental scalers	249-252
		DERBY-PERRY , excavators	280
		DERF , needle holders	66
		DERF , needle holders tungsten TUC	74

	Page		Page
DERF-CONVERSE , needle holders	66	GOLDMAN-FOX , gum scissors	49
DESMARRES , delicate retractors	93	GOLDMAN-FOX , scalers	259
DINGMANN , mouth gags	143	GOLDMAN-FOX , scissors tungsten TUC	57
Dissecting forceps with tungsten TUC	27, 28	GOLDSTEIN , composite instruments	302
Dissecting, scissors	39-42	GOSLEE , flat nose pliers	324
Dissectors	148	GRACEY STANDARD , curettes	256
Distal cutters	319	GRAEFE , eye scissors	45
Double lever stopcock burner	159	GRAZIL , operating scissors	37
DOUGLAS , trocars	105	GREEN-SENN , delicate retractors	92
DOYEN , needle holders	66	GRITMANN , plaster knife	308
DOYEN , probes	103	GROSS-MAIER , polypus forceps	87
Dressing and tissue forceps	19-23	Gum knives	64
DUMONT , flat nose pliers	322	Gum scissors	49, 50
		GUTHRIE , delicate hooks	91
E		H	
EISELSBERG , ligature scissors	46	HAJEK , mallets	125
Enamel chisels	281-284	HAJEK-KOFFLER , sphenoid punches	137
End- and side nippers	316	HALSEY , needle holders	67
ENGL.MODELL , towel forceps	14	HALSEY , needle holders tungsten TUC	74
EWALD , dressing and tissue forceps	21	HALSTED , artery forceps	10
Excavators	275-280	HALSTED-MOSQUITO , artery forceps	9
Explorers	271, 272	HARRIS , extracting forceps, american pattern	212
Extracting forceps for children, american pattern	223, 224	HARTMANN , artery forceps	8
Extracting forceps for children, english pattern	195-202	HARTMANN , tongue depressors	146
Extracting forceps, american pattern	205-224	HARVEY , wire cutting scissors	47
Extracting forceps, Elegance	187-194	HEGAR-MAYO , needle holders	68
Extracting forceps, english pattern	161-204	HEGAR-MAYO , needle holders tungsten TUC	73
		HEGAR-MAYO-DELICATE(DE BAKEY) , needle holders TUC	73
F		HEGAR-MAYO-DELICATE , needle holders	68
FAHNENSTOCK , wax knife	308	HEGAR-OLSEN , needle holders	69
FARABEUF , retractors	99	HEGAR-OLSEN , needle holders tungsten TUC	75
FARREL , cotton applicators	104	HEGAR-OLSEN-USA , needle holders tungsten TUC	75
FELT , composite instruments	302	HEIDBRINK , root elevators	245, 247
Filling instruments	285-302	HEIDEMANN , filling instruments	291
Fine scissors	43-45	HEISTER , mouth gags	140
Finger protectors	140	HEMINGWAY , bone curettes	129
FLAGG , cotton and dressing pliers	30	Hemostats	7, 8-16
Flat nose pliers	313, 322-324	HENAHAN , third molar hook	138
FLOHR , root elevators	227	HILGERS , mouth mirrors	150
Forceps	17-32	Hoke , osteotomes	121
Forceps, clamp	338	HOLLENBACK , filling instruments	287
Forceps, punch	338	HOLLENBACK , wax, porcelain and modelling carvers	305
Forceps, artery	8, 9-13	HOLLOW-CHOP , flat nose pliers	322
Forceps, articulating paper	32	Hooks, delicate	90-93
Forceps, cotton and dressing pliers	29-31	HOW , ligature pliers	318
Forceps, dressing and tissue	19-23	HYGIENIST , dental scalers	252
Forceps, non-traumatic vascular tissue	26	HYLIN , root elevators	236
Forceps, polypus and dressing	87, 88	HYLIN , wax, porcelain and modelling carvers	306
Forceps, splinter	24, 25		
Forceps, sponge holding	87	I	
Forceps, suture	31	Implantology	339-346
Forceps, towel	14, 15	Implantology caliper	344
Forceps, tungsten TUC	27, 28	Impression trays	327-330
Forceps, wire twisting tungsten TUC	79	Impression trays for partial impressions	331, 332
FOX-GOLDMAN (SPECIAL) , gum scissors	49	Instruments for crown work	309, 310
FOX-GOLDMAN , gum scissors	49	IVORY , amalgam carrier	299
FOX-GOLDMAN , scissors tungsten TUC	57	IVORY , clamp forceps	338
FRAHM , wax, porcelain and modelling carvers	305	IVORY , matrix retainers	335, 336
FRAZIER , suction tubes	106	IWANSON , spring caliper	116
FRENZEL , tongue depressors	147		
FRIEDMAN , bone rongeurs	131	J	
FRIEDMAN , root elevators	234	JACOBSON , micro needle holders	83
		JACOBSON , micro needle holders tungsten TUC	80
G		JAMESON , caliper	114
GERALD , dissecting and tissue forceps	23	JANSEN , bone curettes	128
GILLIES , dissecting forceps tungsten TUC	27	Jars	156
GILLIES , needle holders	69	JENNINGS , mouth gags	141
GILLIES , needle holders tungsten TUC	76	JEWELER , dissecting forceps tungsten TUC	27
Gingivectomy knives	260, 261	JONES , towel forceps	14
Glass mixing slabs	159	JOSEPH , delicate hooks	91
GOLDMAN-FOX (SPECIAL) , gum scissors	49	JOSEPH , dissecting scissors	42
GOLDMAN-FOX , gingivectomy knives	260		

	Page		Page
K			
KAPLAN-CRANE , pocket markers	32	Matrix bands and retainers	335-337
KAYE , face-lift-scissors TUC	57	MAUNDER , oral wedges	140
KELLS , extracting forceps, american pattern	222	MAYFIELD , bone rongeurs	132
KELLY , artery forceps	10	MAYO , safety pins	157
KELLY , scissors	38	MAYO , scissors	38
KELLY , scissors tungsten TUC	54	MAYO , tongue depressors	147
KELLY-RANKIN , artery forceps	10	MAYO-HEGAR , needle holders	68
KERRISON , sphenoid punches	137	MAYO-HEGAR , needle holders tungsten TUC	73
Kidney bowls	153	MAYO-HEGAR-DELICATE(DE BAKEY) , needle holders TUC	73
KILNER (RAGNELL) , scissors	42	MAYO-HEGAR-DELICATE , needle holders	68
KILNER , needle holders	67	McINDOE , dressing forceps	21
KILNER , needle holders tungsten TUC	74	McIVOR , mouth gags	144
KILNER-DOUGHTY , mouth gags	142	McCALL , curettes	255
KIRKLAND , gingivectomy knives	261	McCALL , dental scalers	251
KLEIN , extracting forceps for children english pattern	199, 201, 202	McKESSON , oral wedges	145
KLEINERT-KUTZ , bone rongeurs	133	MEAD , bone rongeurs	132
KNAPP , delicate hooks	91	MEAD , forceps english pattern	186
KOCHER-DELICATE , artery forceps	13	MEAD , mallets	126
KOCHER-LANGENBECK , retractors	98	Measuring instruments	111-118
KOCHER-OCHSNER , artery forceps	12	MERIAM , cotton and dressing pliers	30
KRAUSE , trocars	105	MERSHON , band pusher	309
KROENIG , tongue depressors	147	METZENBAUM , needle holders tungsten TUC	77
L			
LA GRANGE , eye scissors	45	METZENBAUM , scissors	39
LANDGRAF , cotton and dressing pliers	31	METZENBAUM , scissors tungsten TUC	55
LANGENBECK , finger protectors	140	METZENBAUM-BABY , scissors	39
LANGENBECK , needle holders	70	METZENBAUM-DELICATE , scissors	41
LANGENBECK , needle holders tungsten TUC	78	METZENBAUM-DELICATE , scissors tungsten TUC	56
LANGENBECK , retractors	97	METZENBAUM-NELSON , scissors	40
LANGENBECK-DELICATE , needle holders tungsten TUC	78	MEYERDING , delicate retractors	92
LANGENBECK-KOCHER , retractors	98	Micro needle holders	81-83
LANGENBECK-MINI , delicate retractors	92	Micro needle holders tungsten TUC	80
LANGENBECK-RYDER , needle holders tungsten TUC	78	Micro needle holders with pen-type handle	81, 82
LAWRENCE-READ , forceps english pattern	179	Micro scissors	51, 52
LE CRON , wax, porcelain and modelling carvers	306	MICRO-ADSON , dressing and tissue forceps	20
LECLUSE , root elevators	240	MICRO-FRIEDMANN , bone rongeurs	135
LICHTENBERG , needle holders tungsten TUC	77	MICRO-MOSQUITO , artery forceps	9
LICHTENSTEIN , plaster knife	308	MIDDLEDORPF , retractors	99
LICHTWITZ , trocars	105	MILLER , articulating paper forceps	32
Ligature pliers	318	MILLER-APEXO , root elevators	235
Ligature, scissors	46	MILLER-COLBURN , bone files	265, 266
LINDO LEVIAN , root elevators	235	MINI , scalpel blades	62
Lip and cheek retractors	146, 147	MINI , scalpel handles	62
LISTER , dressing forceps	87	MINI-FRIEDMAN , bone rongeurs	131
LISTER , scissors tungsten TUC	58	MINI-LANGENBECK , delicate retractors	92
LITTAUER , ligature scissors	46	MINI-LEXER , chisels	124
LITTAUER-LISTON , bone cutting forceps	136	MINI-LEXER , osteotomes	124
LOCKHART-MUMMERY , probes	104	MITCHELL , dental scalers	251
LOCKLIN , gum scissors	49	Mixing slaps, glas	159
LOCKLIN , scissors tungsten TUC	58	MOD.WÜRZBURG , mouth gags	144
LONDON COLLEGE , cotton and dressing pliers	29	MOLT , mouth gags	140
LORNA , towel forceps	15	MOLT , raspatories	130, 263
LOTH-SCHOEMAKER , ligature scissors	46	MORITZ-SCHMIDT , tongue depressors	146
LUCAE , mallets	126	MOSQUITO-HALSTED , artery forceps	9
LUCAS , bone curettes	129	MOSQUITO-MICRO , artery forceps	9
LUCAS , chisels	121	Mouth / Tongue	139-150
LUER , bone rongeurs	132	Mouth gags	140-144
LUER , suction tubes	107	Mouth mirror handles	149
LUNIATSCHECK , dissectors	148	Mouth mirrors	150
M			
MAIER-GROSS , polypus forceps	87	MUMMERY-LOCKHART , probes	104
Mallets	125, 126	MYRTLE LEAF , probes	103
MARTINI , bone curettes	128	N	
MATHIEU , needle holders	69	NANCE , clasp bending pliers	320
MATHIEU , needle holders tungsten TUC	76	NANCE , distal cutter, wire bending pliers	319
MATHIEU-DELICATE , needle holders	69	Napkin holder	157
MATHIEU-DELICATE , needle holders tungsten TUC	76	Needle holders	66-70
Matrix	333-338	Needle holders, micro	81-83
		Needle holders, micro tungsten TUC	80
		Needle holders, tungsten TUC	73-78
		Needle sterilizing cases	154
		Needles, special	103, 104
		NEGUS , chest support for mouth gag	144
		NEIVERT , needle holders	67
		NEIVERT , needle holders tungsten TUC	74

	Page		Page
NELATON , probes	103	ROLLET , delicate hooks	91
NELSON-METZENBAUM , scissors	40	Root canal plugger	273
NEUMANN , gum scissors	50	Root elevators	225-248
NEVIUS , extracting forceps, american pattern	217	Root fragment forceps	203
Non-traumatic vascular tissue forceps	26	ROSER-KÖNIG , mouth gags	141
NOYES , iris scissors	51	ROUX , retractors	99
O		RUSKIN , bone rongeurs	134
		RUSKIN-MINI , bone rongeurs	133
OBWEGESER , ramus retractors	96	S	
OBWEGESER , soft tissue retractors	94, 95	Safety pins	157
OCHSENBEIN , periodontal chisels	262	SANVENERO , scissors	42
OCHSNER-KOCHER , artery forceps	12	Scalers	259
OEHLER , dissecting forceps tungsten TUC	27	Scalpel, blades	62, 63
OHL , raspatories	264	Scalpel, handles	61, 62
OLSEN-HEGAR , needle holders	69	Scalpels	59-64
OLSEN-HEGAR , needle holders tungsten TUC	75	SCHAEDEL , towel forceps	14
OLSEN-HEGAR-USA , needle holders tungsten TUC	75	SCHEDÉ , bone curettes	127
OMS , periodontal probes	274	SCHOEMAKER-LOTH , ligature scissors	46
Oral wedges	140, 145	SCHUKNECHT , wire cutting scissors	47
ORBAN , gingivectomy knives	261	SCHWARZ , bar pending pliers	315
Osteotomes	121-124	SCHWARZ , clasp bending pliers	320
P		SCHWARZ , wire bending pliers	321
		Scissors	33-58
PARKER , retractors	99	Scissors, crown	47
PARMILY , extracting forceps, american pattern	214	Scissors, dissecting	39-42
PARTSCH , chisels	123	Scissors, fine	43-45
PARTSCH , mallets	126	Scissors, gum	49, 50
PEAN , seizing forceps	8	Scissors, ligature	46
PEAN-DELICATE , artery forceps	13	Scissors, micro	51, 52
PEAN-ROCHESTER , artery forceps	11	Scissors, operating	36-38
PEERS , towel forceps	15	Scissors, strabismus	45
PEET , splinter forceps	25	Scissors, super-cut SC	35
Perforated steel basket	362	Scissors, tungsten TUC	54-58
Periodontal chisels	262	Scissors, wire cutting	47
Periodontal probes	274	SECCO , mouth mirror handles	149
Periodontology	253-268	SEEMANN-SEIFFERT , mouth gags	141
PERRY , cotton and dressing pliers	31	SELDIN , raspatories	263
PIERCE , trocars	105	SELDIN , root elevators	231
PITHA , oral wedges	140	SEMKEN , dissecting forceps tungsten TUC	27
Plane condenser	289	SENN-GREEN , delicate retractors	92
Plaster knives	308	SILVER-POINT , forceps	25
Plastic tip	299	SIMPLEX , cheek retractors	146
Pocket markers	32	SMITH , wire cutting scissors	47
Polypus and dressing forceps	87, 88	SMITH-POTTS , dissecting forceps tungsten TUC	27
POTT , root elevators	241	Soft tissue retractors	94, 95
POTTS-SMITH , dissecting forceps tungsten TUC	27	Spatula	297
PRATT , fistula probe	104	Special needles	103, 104
PRICHARD , raspatories	263	SPENCER , ligature scissors	46
Probes	269-274	SPENCER-DELICATE , ligature scissors	46
Probes and special needles	101-110	Sphenoid punches	137
Prothetics and orthodontia	303-332	Splinter forceps	24, 25
Punch forceps	338	Sponge forceps	85-88
PYE-SMITH (HARRISON) , safety pins	157	SPRATT , bone curettes	127
Q		Spreader	273
		STACKE , probes	103
QUINBY , gum scissors	50	Standard trays and accessories	353-362
R		Dressing and tissue forceps	19
		STANDARD , gum scissors	50
RAGNELL (KILNER) , scissors	42	STANDARD , operating scissors	36
RALK , splinter forceps	25	STANDARD , tongue depressors	147
Ramus retractors	96	STELLBRINK , bone rongeurs	131
RANKIN-CRILE , artery forceps	11	Sterilizing containers and standard trays	347-362
RANKIN-KELLY , artery forceps	10	STERNBERG , cheek and lip retractors	146
Raspatories	130, 263, 264	STERNUM , wire forceps	312
REILL , micro needle holders	81	STERNUM , wire twisting forceps tungsten TUC	79
Retractors	89-100	STEVENS , scissors tungsten TUC	57
REYNOLDS , scissors	42	STEVENS , tenotomy scissors	45
ROCHESTER-PEAN , artery forceps	11	STIEGLITZ , splinter forceps	25
ROEDER , towel forceps	15	STOCKES , clamp forceps	338
ROGGE , safety pins	157	Storing tray	361
		Strabismus scissors	45
		Suction tubes	106-108

	Page		Page
SULLIVAN (BROPHY) , fine scissors	43	WILLIGER , raspatories	130
SULLIVAN , gum scissors	50	WILMER , eye scissors	45
Super Cut Scissors	35	WINTER , root elevators	243
Suture	65-84	Wire bending pliers	319, 321
Suture, forceps	31	Wire cutting scissors	47
Suture, tweezers	31	Wire forceps	311-314
T		WITZEL , root fragment forceps	203
TAYLOR , tissue and dressing forceps	22	WOODSON , filling instruments	292
TAYLOR-CUSHING , dissecting forceps tungsten TUC	28	WOODWARD , extracting forceps, american pattern	209
Telescopic crown pliers	325	WYNMAN , crown gripper	310
TERRIER , artery forceps	8	Y	
THIESS , mallets	126	YOUNG , tongue holding forceps	148
Third molar hook	138	YOUNG , wire bending pliers	321
THOMAS , wax, porcelain and modelling carvers	307	YOUNGER-GOOD , dental scalers	251
Tissue and dressing forceps	19-23	Z	
TOBOLD , tongue depressors	146	ZAHLE , wax, porcelain and modelling carvers	306
TOENNIS , needle holders	70	ZAUFAL-JANSEN , bone rongeurs	134
TOENNIS , needle holders tungsten TUC	77		
TOENNIS-ADSON-DELICATE , scissors tungsten TUC	57		
TOFFLEMIRE , matrix bands	337		
TOFFLEMIRE-UNIVERSAL , matrix retainers	337		
TOHOKU-JAPAN , towel forceps	15		
TOMES , extracting forceps, american pattern	216		
Tongue depressors	146, 147		
Tongue holding forceps	148		
Towel forceps	14, 15		
TOWNER , dental scalers	251		
TOWNLEY , caliper	114		
Trephine burrs	344		
TREYMANN , crown remover	309		
Trocars	105		
U			
UNIV.MINNESOTA , tongue depressors	147		
Universal pliers	317		
Universal trays	155		
UNIVERSAL , bone rongeurs	131		
UNIVERSAL , scissors tungsten TUC	58		
UNIVERSAL , universal pliers	317		
UNIVERSAL , wire cutting scissors	47		
USA , filling instruments	291		
USA , punch forceps	338		
V			
Various items	151-160		
VERNIER , calipers	114, 115		
VOLKMANN , bone curettes	127		
W			
W.F. BARRY , root elevators	242		
WAGNER , fine scissors	43		
WALDSACHS , universal pliers	317		
WALTON , polypus forceps	88		
WARD , wax, porcelain and modelling carvers	305		
WARWICK-JAMES , root elevators	241		
Wax knife	308		
Wax, porcelain and modelling carvers	305-308		
WEBSTER , needle holders	67		
WEBSTER , needle holders tungsten TUC	74		
WECKER , iris scissors	51		
WEDELSTAEDT , enamel chisels	284		
WEINGART , ligature pliers	318		
WEST , raspatories	264		
WEST , root elevators	248		
WESTCOTT , tenotomy scissors	52		
WHITE , excavators	278		
WHITEHEAD , mouth gags	142		
WHO , periodontal probes	274		
WIEDER , tongue depressors	146		
WILLIGER , bone curettes	128		

Indice alfabética

	Página		Página
A			
Abaja-lenguas	144, 147	Cadres de esterilización	157
Abre-bocas	140-144	Cajas para esterilización y bandejas estandar	347-362
ADAMS , alicates para cortar alambres, para doblar alambres	319	Cajas para instrumentos	155
ADAMS , porta-servilletas	157	Calibrador	114-116
ADERER , alicates para doblar alambres	321	Calibradores de implantología	344
ADERER , alicates para doblar ganchos	320	Calibro micrometrío	114, 115
ADERER , alicates para sacar bandas	319	CARREL , pinzas hemostáticas	8
ADSON , pinzas de disección	20, 21	CARROLL , porta-agujas	68
ADSON , pinzas de disección tungsteno TUC	28	CASTROVIEJO , círculo	117
ADSON-BABY , pinzas para preparaciones y ligaduras	13	CASTROVIEJO , micro-porta-agujas	83
ADSON-BROWN , pinzas de disección	21	CASTROVIEJO , micro-porta-agujas tungsteno TUC	80
ADSON-MICRO , pinzas de disección	20	CASTROVIEJO , pinzas-tijeras para córnea	51
ADSON-TOENNIS-DELICATE , tijeras tungsteno TUC	57	CASTROVIEJO , pinzas-tijeras para iridectomia	51
AINSWORTH , perforadores	338	CASTROVIEJO-EPKER , círculo	118
Ajustador de bandas	309	Cestillo de acero perforado	362
ALEXANDER , cinceles	122	CHADWICK , tijeras oculares	45
Alicates cortantes	316	CHEATLE , pinzas para esterilización	157
Alicates de pico plano	322-324	CHOMPRET , elevadores para raíces	244
Alicates extendedores de coronas	309	Cinceles	121-124
Alicates para coronas telescópicas	325	Cinceles de periodoncia	262
Alicates para cortar alambres	319	Cinceles y Gubias	121-124
Alicates para doblar alambres	315,316,319,321	Cinseles para esmalte	281-284
Alicates para doblar ganchos	320	Cizallas para cortar alambre	47
Alicates para ligatura	318	CLEVELAND , pinzas cortantes para huesos	136
Alicates para sacar bandas	319	CLEVELAND , pinzas-gubias	131
Alicates planos	313	CLEVELAND-GARDNER , pinzas cortantes p.huesos	136
Alicates universales	317	COGSWELL , tubos de aspiración	107
ANGLE , alicates para cortar alambres, para doblar alambres	319, 321	COLEMAN , elevadores para raíces	232
APICAL , elevadores para raíces	229, 230	COLLER , pinzas hemostáticas	10
ARRUGA , porta-agujas	66	COLLIER , porta-agujas	66
ARRUGA , porta-agujas tungsteno TUC	77	COLLIN , martillos	125
B			
BABY-ADSON , pinzas para preparaciones y ligaduras	13	COLLIN , pinzas tira-lengua	148
BABY-CRILE-WOOD , porta-agujas	68	COLUMBIA , curettas	255
BABY-CRILE-WOOD , porta-agujas tungsteno TUC	75	Combinación bola/espátula	296
BABY-METZENBAUM , tijeras para preparaciones	39	Condensador plano	289
BACKHAUS , pinzas de campo	14	Condensador tipo bola	295
BACKHAUS , pinzas para compresas	14	CONVERSE , porta-agujas tungsteno TUC	74
BALL & SOCKET , pinzas de campo	15	CONVERSE-DERF , porta-agujas	66
Bandejas estándar y accesorios	353-362	Copas graduadas	153
BEALE , talladores y espátulas para cera, porcelana y modelar	306	CORWIN , pinzas para hilos	312
BEEBEE , tijeras para coronas	47, 48	CORWIN , pinzas para torcer hilos tungsteno TUC	79
BEIN , elevadores para raíces	237	COUPLAND , elevadores para raíces	233
BENNET , instrumentos para obturaciones	298	COUPLAND , tubos de aspiración	106, 108
BEYER , pinzas-gubias	133	CRANE-KAPLAN , pinzas para bolsas	32
Bisturíes	59-64	CRILE , pinzas hemostáticas	11
Bisturíes para encías	64	CRILE-RANKIN , pinzas hemostáticas	11
Bisturíes para la gingivectomía	260, 261	CRILE-WOOD , porta-agujas	68
BLACK , cinseles para esmalte	283	CRILE-WOOD , porta-agujas tungsteno TUC	75
BLUMENTHAL , pinzas-gubias	132	CRILE-WOOD-BABY , porta-agujas	68
Boca / lengua	139-150	CRILE-WOOD-BABY , porta-agujas tungsteno TUC	75
BÖHLER , pinzas-gubias	133	CROWN-REMOVER , instrumentos para coronas	310
BÖHM , alicates para coronas telescópicas	325	CRYER , elevadores para raíces	228
BOLEY , calibre micrometrío	115	CRYER , forceps de extracción, forma americana	218, 220, 221
BOYNTON , porta-agujas	66	Cubetas	153, 155, 156
BOYNTON , porta-agujas tungsteno TUC	77	Cubetas para impresiones	327-330
BREWER , portaclamps	338	Cubetas para impresiones parciales	331-332
BRODIE , sondas	104	Cucharillas cortantes	127-129
BROPHY(SULLIVAN) , tijeras finas	43	Cuchillo para cero	308
BROWN-ADSON , pinzas de disección	21	Cuchillo para yeso	308
BRUENINGS , abaja-lenguas	147	CUMINE , limpiadores de sarro	251
BRUNS , cucharillas cortantes	127	Cunas	153
BYRD , tubos de aspiración	106	Curettas	255, 256
D			
		CUSHING , pinzas de disección	23
		CUSHING , pinzas de disección tungsteno TUC	28
		CUSHING-TAYLOR , pinzas de disección tungsteno TUC	28

DARBY-PERRY, excavador	280	GOLDMAN-FOX, tijeras tungsteno TUC	57
DAVIS-BOYLE, abre-bocas	143	GOLDSTEIN, instrumentos para composites	302
DE BAKEY, pinzas atrauma	26	GOSLEE, alicates de pico plano	324
DE BAKEY, porta-agujas tungsteno TUC	73	GRACEY STANDARD, curettas	256
DEAN, tijeras para encías	49	GRAEFE, tijeras oculares	45
DEAN, tijeras tungsteno TUC	58	GRAZIL, tijeras para cirugía	37
DEAN-DELICATE, tijeras para encías	49	GREEN-SENN, separadores finas	92
Dedales	140	GRITMANN, cuchillo para yeso	308
DENHART, abre-bocas	141	GROSS-MAIER, pinzas para pólipos	87
DERF, porta-agujas	66	Gubias	121-124
DERF, porta-agujas tungsteno TUC	74	GUTHRIE, ganchos	91
DERF-CONVERSE, porta-agujas	66		
DESMARRES, separadores finas	93	H	
DINGMANN, abre-bocas	143	HAEK, martillos	125
Disecadores	148	HAEK-KOFFLER, pinzas para seno esfenoidal	137
Distribuidores para algodón	158	HALSEY, porta-agujas	67
Diversos artículos	151-160	HALSEY, porta-agujas tungsteno TUC	74
DOUGLAS, trocares	105	HALSTED, pinzas hemostáticas	10
DOYEN, porta-agujas	66	HALSTED-MOSQUITO, pinzas hemostáticas	9
DOYEN, sondas	103	HARRIS, forceps de extracción, forma americana	212
DUMONT, alicates de pico plano	322	HARRISON (PYE-SMITH), pinzas para esterilización	157
E		HARTMANN, abaja-lenguas	146
EISELSBERG, tijeras para ligaduras	46	HARTMANN, pinzas hemostáticas	8
Elevadores para raíces	225-248	HARVEY, cizallas para cortar alambre	47
ENGL.MODELL, pinzas de campo	14	HEGAR-MAYO, porta-agujas	68
ENGL.MODELL, pinzas para compresas	14	HEGAR-MAYO, porta-agujas tungsteno TUC	73
Espátula	297	HEGAR-MAYO-DELICATE, porta-agujas	68
Espátulas para mezclar	300, 301	HEGAR-MAYO-DELICATE, porta-agujas tungsteno TUC	73
Espejos de boca	150	HEGAR-OLSEN, porta-agujas	69
Estilete para fistulas	104	HEGAR-OLSEN, porta-agujas tungsteno TUC	75
Estuches para esterilizar agujas	154	HEGAR-OLSEN-USA, porta-agujas tungsteno TUC	75
EWALD, pinzas de disección	21	HEIDEBRINK, elevadores para raíces	245, 247
Excavadores	275-280	HEIDEMANN, instrumentos para obturaciones	291
Extendedor	273	HEISTER, abre-bocas	140
Extractor de coronas	309	HEMINGWAY, cucharillas cortantes	129
F		HENAHAN, ganchito retractor de la muela del juicio	138
FAHNENSTOCK, cuchillo para cero	308	HILGER, espejos de boca	150
FARABEUF, separadores	99	Hojas de bisturíes	62, 63
FARRELL, porta-algodones	104	HOKE, gubias	121
FELT, instrumentos para composites	302	HOLLENBACK, instrumentos para obturaciones	287
FLAGG, pinzas para algodón y curaciones	30	HOLLENBACK, talladores y espátulas para cera, porcelana y modelar	305
FLOHR, elevadores para raíces	227	HOLLOW-CHOP, alicates de pico plano	322
Forceps de extracción para niños, forma inglesa	195-202	HOW, alicates para ligatura	318
Forceps de extracción, Elegance	187-194	HYGIENIST, limpiadores de sarro	252
Forceps de extracción, forma americana	205-224	HYLIN, elevadores para raíces	236
Forceps de extracción, forma inglesa	161-204	HYLIN, talladores y espátulas para cera, porcelana y modelar	306
Forceps para fragmentos de raíces	203		
Forceps para niños, forma americana	223, 224	I	
FOX-GOLDMAN(SPEZIAL), tijeras para encías	49	Implantología	339-346
FOX-GOLDMAN, tijeras para encías	49	Instrumentos amalgamas	299
FOX-GOLDMAN, tijeras tungsteno TUC	57	Instrumentos para composites	302
FRAHM, talladores y espátulas para cera, porcelana y modelar	305	Instrumentos para coronas	309, 310
FRAZIER, tubos de aspiración	106	Instrumentos para hueso	119-138
FRENZEL, abaja-lenguas	147	Instrumentos para medidas	111-118
Fresas trephines	344	Instrumentos para obturaciones	285-302
FRIEDMAN, elevadores para raíces	234	IVORY, porta amalgamas	299
FRIEDMAN, pinzas-gubias	131	IVORY, porta clamps	338
G		IVORY, porta matrices	335, 336
Ganchito retractor de la muela del juicio	138	IWANSON, calibrador	116
Ganchos	90-93		
Garrotes	140, 145	J	
GERALD, pinzas de disección	23	JACOBSON, micro-porta-agujas	83
GILLIES, pinzas de disección tungsteno TUC	27	JACOBSON, micro-porta-agujas tungsteno TUC	80
GILLIES, porta-agujas	69	JAMESON, calibre micrometro	114
GILLIES, porta-agujas tungsteno TUC	76	JANSEN, cucharillas cortantes	128
GOLDMAN-FOX(SPEZIAL), tijeras para encías	49	JENNINGS, abre-bocas	141
GOLDMAN-FOX, bisturíes para la gingivectomía	260	Jeringas de aplicación	341
GOLDMAN-FOX, limpiadores de sarro	259	Jeringas de hueso	342, 343
GOLDMAN-FOX, tijeras para encías	49	Jeringas para cartucho apollas	109
		JEWELER, pinzas de disección tungsteno TUC	27
		JONES, pinzas de campo	14

	Página		Página
JONES , pinzas para compresas	14	MATHIEU , porta-agujas tungsteno TUC	76
JOSEPH , ganchos	91	MATHIEU-DELICATE , porta-agujas	69
JOSEPH , tijeras para preparaciones	42	MATHIEU-DELICATE , porta-agujas tungsteno TUC	76
K		Matrices	333-338
KAPLAN-CRANE , pinzas para bolsas	32	MAUNDER , garrote	140
KAYE , tijeras para Face-lift	57	MAYFIELD , pinzas-gubias	132
KELLS , forceps de extracción, forma americana	222	MAYO , abaja-lenguas	147
KELLY , pinzas hemostáticas	10	MAYO , cadres de esterilización	157
KELLY , tijeras para fistulas	38	MAYO , tijeras	38
KELLY , tijeras tungsteno TUC	54	MAYO-HEGAR , porta-agujas	68
KELLY-RANKIN , pinzas hemostáticas	10	MAYO-HEGAR , porta-agujas tungsteno TUC	73
KERRISON , pinzas para seno esfenoidal	137	MAYO-HEGAR-DELICATE , porta-agujas	68
KILNER(RAGNELL) , tijeras para preparaciones	42	MAYO-HEGAR-DELICATE , porta-agujas tungsteno TUC	73
KILNER , porta-agujas	67	McINDOE , pinzas de disección	21
KILNER , porta-agujas tungsteno TUC	74	McIVOR , abre-bocas	144
KILNER-DOUGHTY , abre-bocas	142	McCALL , curettas	255
KIRKLAND , bisturios para la gingivectomía	261	McCALL , limpiadores de sarro	251
KLEIN , forceps para niños, forma inglesa	199, 201, 202	McKESSON , garrotes	145
KLEINERT-KUTZ , pinzas-gubias	133	MEAD , forceps de extracción, forma inglesa	186
KNAPP , ganchos	91	MEAD , martillos	126
KOCHER-DELICATE , pinzas hemostáticas	13	MEAD , pinzas-gubias	132
KOCHER-LANGENBECK , separadores	98	Mecheros con llave de palanca doble	159
KOCHER-OCHSNER , pinzas hemostáticas	12	MERIAM , pinzas para algodón y curaciones	30
KRAUSE , trocares	105	MERSHON , ajustador de bandas	309
KROENIG , abaja-lenguas	147	METZENBAUM , porta-agujas tungsteno TUC	77
L		METZENBAUM , tijeras para preparaciones	39
LA GRANGE , tijeras oculares	45	METZENBAUM , tijeras tungsteno TUC	55
LANDGRAF , pinzas para algodón y curaciones	31	METZENBAUM-BABY , tijeras para preparaciones	39
LANGENBECK , dedales	140	METZENBAUM-DELICATE , tijeras para preparaciones	41
LANGENBECK , porta-agujas	70	METZENBAUM-DELICATE , tijeras tungsteno TUC	56
LANGENBECK , porta-agujas tungsteno TUC	78	METZENBAUM-NELSON , tijeras para preparaciones	40
LANGENBECK , separadores	97	MEYERDING , separadores finas	92
LANGENBECK-DELICATE , porta-agujas tungsteno TUC	78	Micro tijeras	51, 52
LANGENBECK-KOCHER , separadores	98	Micro, porta-agujas	81-83
LANGENBECK-MINI , separadores finas	92	MICRO-ADSON , pinzas de disección	20
LANGENBECK-RYDER , porta-agujas tungsteno TUC	78	MICRO-FRIEDMANN , pinzas-gubias	135
LAWRENCE-READ , forceps de extracción, forma inglesa	179	MICRO-MOSQUITO , pinzas hemostáticas	9
LE CRON , talladores y espátulas para cera, porcelana y modelar	306	Micro-porta-agujas con mango redondo	81, 82
LECLUSE , elevadores para raíces	240	MIDDELDORPF , separadores	99
LICHTENBERG , porta-agujas tungsteno TUC	77	MILLER , pinzas para papel de articular	32
LICHTENSTEIN , cuchillo para yeso	308	MILLER-APEXO , elevadores para raíces	235
LICHTWITZ , trocares	105	MILLER-COLBURN , limas para huesos	265, 266
Limas para huesos	265-267	MINI , hojas de bisturios	62
Limpiadores de sarro	249-252, 259	MINI , mangos de bisturios	62
LINDO LEVIAN , elevadores para raíces	235	MINI-FRIEDMAN , pinzas-gubias	131
LISTER , pinzas para tapones	87	MINI-LANGENBECK , separadores finas	92
LISTER , tijeras tungsteno TUC	58	MINI-LEXER , cinceles	124
LITTAUER , tijeras para ligaduras	46	MINI-LEXER , gubias	124
LITTAUER-LISTON , pinzas cortantes para huesos	136	MITCHELL , limpiadores de sarro	251
LOCKHART-MUMMERY , sondas	104	MOD.WÜRZBURG , abre-bocas	144
LOCKLIN , tijeras para encías	49	Molino de huesos	345
LOCKLIN , tijeras tungsteno TUC	58	MOLT , abre-bocas	140
LONDON-COLLEGE , pinzas para algodón y curaciones	29	MOLT , raspadores	130, 263
LORNA , pinzas de campo	15	MORITZ-SCHMIDT , abaja-lenguas	146
LORNA , pinzas para compresas	15	MOSQUITO-HALSTED , pinzas hemostáticas	9
LOTH-SCHOEMAKER , tijeras para ligaduras	46	MOSQUITO-MICRO , pinzas hemostáticas	9
LUCAE , martillos	126	MUMMERY-LOCKHART , sondas	104
LUCAS , cinceles	121	MYRTLE LEAF , sondas	103
LUCAS , cucharillas cortantes	129	N	
LUER , pinzas-gubias	132	NANCE , alicates para cortar alambres, para doblar alambres	319
LUER , tubos de aspiración	107	NANCE , alicates para doblar ganchos	320
LUNIATSCHECK , disecadores	148	NEGUS , soporte contra-pecho para abre-bocas	144
M		NEIVERT , porta-agujas	67
MAIER-GROSS , pinzas para pólipos	87	NEIVERT , porta-agujas tungsteno TUC	74
Mangos de bisturios	61, 62	NELATON , sondas	103
Mangos para espejos de boca	149	NELSON-METZENBAUM , tijeras para preparaciones	40
Martillos	125, 126	NEUMANN , tijeras para encías	50
MARTINI , cucharillas cortantes	128	NEVIUS , forceps de extracción, forma americana	217
MATHIEU , porta-agujas	69	NOYES , pinzas-tijeras para iridectomia	51
		O	
		Obturador	273

OBWEGESER , separadores para el ramo	96
OBWEGESER , separadores para partes blandes	94, 95
OCHSENBEIN , cinceles de periodoncia	262
OCHSNER-KOCHER , pinzas hemostáticas	12
OEHLER , pinzas de disección tungsteno TUC	27
OHL , raspadores	264
OLSEN-HEGAR , porta-agujas	69
OLSEN-HEGAR , porta-agujas tungsteno TUC	75
OLSEN-HEGAR-USA , porta-agujas tungsteno TUC	75
OMS , sondas paradontales	274
ORBAN , bisturíes para la gingivectomía	261

P

Paradontología	253-268
PARKER , separadores	99
PARMILY , pinzas de extracción, forma americana	214
PARTSCH , cinceles	123
PARTSCH , martillos	126
PEAN , pinzas para coger	8
PEAN-DELICATE , pinzas hemostáticas	13
PEAN-ROCHESTER , pinzas hemostáticas	11
PEERS , pinzas de campo	15
PEERS , pinzas para compresas	15
PEET , pinzas para espinas	25
Perforadores	338
PERRY , pinzas para algodón y curaciones	31
PIERCE , trocares	105
Pinzas	17-32
Pinzas atrauma	26
Pinzas cortantes para huesos	136
Pinzas de campo	14, 15
Pinzas de disección	19-23
Pinzas de disección con dientes	19-23
Pinzas de disección tungsteno TUC	27, 28
Pinzas hemostáticas	7, 8-16
Pinzas para algodón y curaciones	29-31
Pinzas para bolsas	32
Pinzas para coger	8
Pinzas para compresas	14, 15
Pinzas para curaciones	29-31
Pinzas para espinas	24, 25
Pinzas para esponjas	87
Pinzas para esterilización	157
Pinzas para hilos	311-314
Pinzas para papel de articular	32
Pinzas para pólipos	85-88
Pinzas para seno esfenoidal	137
Pinzas para sutura	31
Pinzas para tapones	87
Pinzas para torcer hilos tungsteno TUC	79
Pinzas tira-lengua	148
Pinzas tungsteno TUC	27, 28
Pinzas-gubias	131-135
Pinzas-tijeras para córnea	51
Pinzas-tijeras para iridectomía	51
PITHA , garrote	140
Placa de vidrio a mezcala	159
Porta amalgamas	299
Porta-agujas	66-70
Porta-agujas micro	81-83
Porta-agujas tungsteno TUC	73-78
Porta-aldodones	104
Portaclamps	338
Portamatrices y matrices	335-337
Porta-servilletas	157
POTT , elevadores para raíces	241
POTTS-SMITH , pinzas de disección tungsteno TUC	27
PRATT , estilete para fistulas	104
PRICHARD , raspadores	263
Protesis y ortodoncia	303-332
PYE-SMITH (HARRISON) , pinzas para esterilización	157

Q

QUINBY , tijeras para encias	50
R	
RAGNELL(KILNER) , tijeras para preparaciones	42
RALK , pinzas para espinas	25
RANKIN-CRILE , pinzas hemostáticas	11
RANKIN-KELLY , pinzas hemostáticas	10
Raspadores	130, 263, 264
REILL , micro-porta-agujas	81
REYNOLDS , tijeras para preparaciones	42
ROCHESTER-PEAN , pinzas hemostáticas	11
ROEDER , pinzas de campo	15
ROEDER , pinzas para compresas	15
ROGGE , pinzas para esterilización	157
ROLLET , ganchos	91
ROSER-KÖNIG , abre-bocas	141
ROUX , separadores	99
RUSKIN , pinzas-gubias	134
RUSKIN-MINI , pinzas-gubias	133
RYDER-LANGENBECK , porta-agujas tungsteno TUC	78
S	
SANVENERO , tijeras para preparaciones	42
SCHAEDEL , pinzas de campo	14
SCHAEDEL , pinzas para compresas	14
SCHUDE , cucharillas cortantes	127
SCHOEMAKER-LOTH , tijeras para ligaduras	46
SCHUKNECHT , cizallas para cortar alambre	47
SCHWARZ , alicates para doblar alambres	315, 321
SCHWARZ , alicates para doblar ganchos	320
SECCO , mangos para espejos de boca	149
SEEMANN-SEIFFERT , abre-bocas	141
SELDIN , elevadores para raíces	231
SELDIN , raspadores	263
SEMKEN , pinzas de disección	21, 22
SEMKEN , pinzas de disección tungsteno TUC	27
SENN-GREEN , separadores finas	92
Separadores	89-100
Separadores finas	92, 93
Separadores para el ramo	96
Separadores para labios y mejillas	146, 147
Separadores para partes blandes	94, 95
SILVER-POINT , forceps	25
SIMPLEX , separadores para mejillas	146
SMITH , cizallas para cortar alambre	47
SMITH-POTTS , pinzas de disección tungsteno TUC	27
Sólo aditamento de plástico	29
Sonda dental	271, 272
Sondas	103, 104, 269-274
Sondas paradontales	274
Sondas y agujas especiales	101-110
Soporte contra-pecho para abre-bocas	144
SPENCER , tijeras para ligaduras	46
SPENCER-DELICATE , tijeras para ligaduras	46
SPRATT , cucharillas cortantes	127
STACKE , sondas	103
STANDARD , abaja-lenguas	147
STANDARD , pinzas de disección	19
STANDARD , pinzas de disección con dientes	19
STANDARD , tijeras para cirugía	36
STANDARD , tijeras para encias	50
STELLBRINK , pinzas-gubias	131
STERNBERG , separadores para mejillas y labios	146
STERNUM , pinzas para hilos	312
STERNUM , pinzas para torcer hilos tungsteno TUC	79
STEVENS , tijeras para tenotomía	45
STEVENS , tijeras tungsteno TUC	57
STIEGLITZ , pinzas para espinas	25
STOCKES , portaclamps	338
SULLIVAN(BROPHY) , tijeras finas	43
SULLIVAN , tijeras para encias	50
Super Cut Tijeras	35
Sutura	65-84

	Página		Página
T			
Talladores y espátulas para cera, porcelana y modelar	305-308	WHO , sondas paradontales	274
Tarros	156	WIEDER , abaja-lenguas	146
TAYLOR , pinzas de disección	22	WILLIGER , cucharillas cortantes	128
TAYLOR-CUSHING , pinzas de disección tungsteno TUC	28	WILLIGER , raspadores	130
TERRIER , pinzas hemostáticas	8	WILMER , tijeras oculares	45
THIESS , martillos	126	WINTER , elevadores para raíces	243
THOMAS , talladores y espátulas para cera, porcelana y modelar	307	WITZEL , pinzas para fragmentos de raíces	203
Tijeras	33-58	WOODSON , instrumentos para obturaciones	292
Tijeras finas	43-45	WOODWARD , pinzas de extracción, forma americana	209
Tijeras micro	51, 52	WYNMAN , alicate de corona	310
Tijeras oculares	45	Y	
Tijeras para cirugía	36-38	YOUNG , alicates para doblar alambres	321
Tijeras para coronas	47, 48	YOUNG , pinzas tira-lengua	148
Tijeras para encías	49, 50	YOUNGER-GOOD , limpiadores de sarro	251
Tijeras para estrabismos	45	Z	
Tijeras para fistulas	38	ZAHLE , talladores y espátulas para cera, porcelana y modelar	306
Tijeras para ligaduras	46	ZAUFAL-JANSEN , pinzas-gubias	134
Tijeras para preparaciones	39-42		
Tijeras para tenotomía	45		
Tijeras Super-cut SC	35		
Tijeras tungsteno TUC	54-58		
TOBOLD , abaja-lenguas	146		
TOENNIS , porta-agujas	70		
TOENNIS , porta-agujas tungsteno TUC	77		
TOENNIS-ADSON-DELICATE , tijeras tungsteno TUC	57		
TOFFLEMIRE , matrices	337		
TOFFLEMIRE-UNIVERSAL , portamatrices	337		
TOHOKU-JAPAN , pinzas de campo	15		
TOHOKU-JAPAN , pinzas para compresas	15		
TOMES , forceps de extracción, forma americana	216		
TOWNER , limpiadores de sarro	251		
TOWNLEY , calibre micrometrío	114		
Tray para depositar	361		
TREYMAN , extractor de coronas	309		
Trocares	105		
Tubos de aspiración	106-108		
U			
UNIV. MINNESOTA , abaja-lenguas	147		
UNIVERSAL , alicates universales	317		
UNIVERSAL , cizallas para cortar alambre	47		
UNIVERSAL , pinzas-gubias	131		
UNIVERSAL , tijeras tungsteno TUC	58		
USA , instrumentos para obturaciones	291		
USA , perforadores	338		
V			
Vaso dappen	158		
VERNIER , calibrador	114, 115		
VOLKMANN , cucharillas cortantes	127		
W			
W.F. BARRY , elevadores para raíces	242		
WAGNER , tijeras finas	43		
WALDSACHS , alicates universales	317		
WALTON , pinzas para pólipos	88		
WARD , talladores y espátulas para cera, porcelana y modelar	305		
WARWICK-JAMES , elevadores para raíces	241		
WEBSTER , porta-agujas	67		
WEBSTER , porta-agujas tungsteno TUC	74		
WECKER , pinzas-tijeras para iridectomía	51		
WEDELSTAEDT , cinceles para esmalte	284		
WEINGART , alicates para ligatura	318		
WEST , elevadores para raíces	248		
WEST , raspadores	264		
WESTCOTT , micro-tijeras	52		
WESTCOTT , pinzas-tijeras para córnea	52		
WHITE , excavadores	278		
WHITEHEAD , abre-bocas	142		

Index

	Page		Page
A			
Abaisse-langues	146, 147	CARREL , pinces hémostatiques	8
ADAMS , pince coupeur distale, pince pour technique	319	CARROLL , porte-aiguilles	68
ADAMS , porte-serviettes	157	CASTROVIEJO , ciseaux à iridectomie	51
ADERER , pince coupeur distale, pince pour technique	319	CASTROVIEJO , ciseaux cornéales	51
ADERER , pinces à courber agrafes	320	CASTROVIEJO , compas	117
ADERER , pinces à courber fils	321	CASTROVIEJO , micro-porte-aiguilles	83
ADSON , pinces à dissection tungstène TUC	28	CASTROVIEJO , micro-porte-aiguilles tungstène TUC	80
ADSON-BABY , pinces à dissection et à ligatures	13	CASTROVIEJO-EPKER , compas	118
ADSON-BROWN , pinces à griffes	21	CHADWICK , ciseaux oculaires	45
ADSON-MICRO , pinces à dissection et à griffes	20	CHEATLE , pinces à stérilisation	157
ADSON-TOENNIS-DELICATE , ciseaux tungstène TUC	57	CHOMPRET , elevateurs à racines	244
AINSWORTH , pince à perforer	338	Cisailles pour fils	47
Ajusteur de bande	309	Ciseaux	33-58
ALEXANDER , ciseaux-burins	122	Ciseaux à chirurgie	36-38
ANGLE , pince coupeur distale, pince pour technique	319	Ciseaux à couronnes	47, 48
ANGLE , pinces à courber fils	321	Ciseaux à dissection	39-42
APICAL , elevateurs à racines	229, 230	Ciseaux à émail	281-284
Appendice en plastique	299	Ciseaux à gencives	49, 50
ARRUGA , porte-aiguilles	66	Ciseaux à iridectomie	51
ARRUGA , porte-aiguilles tungstène TUC	77	Ciseaux à ligatures	46
Articles divers	151-160	Ciseaux à préparation	39-42
		Ciseaux à strabisme	45
		Ciseaux à ténotomie	45
		Ciseaux fins	43-45
		Ciseaux micro	51, 52
		Ciseaux oculaires	45
		Ciseaux super cut SC	35
		Ciseaux tungstène TUC	54-58
		Ciseaux-burins	121-124
B			
BABY-ADSON , pinces à dissection	13	CLEVELAND , pinces coupantes à os	136
BABY-CRILE-WOOD , porte-aiguilles	68	CLEVELAND , pinces-gouges	131
BABY-CRILE-WOOD , porte-aiguilles tungstène TUC	75	CLEVELAND-GARDNER , pinces coupantes à os	136
BABY-METZENBAUM , ciseaux à dissection	39	Clips de stérilisation	157
BACKHAUS , pinces à champs	14	COAKLEY , trocarts	105
Baillons	140, 145	COGSWELL , canules d'aspiration	107
BALL & SOCKET , pinces a champs	15	COLEMAN , elevateurs à racines	232
Bassins réniiformes	153	COLLEGE LONDON , précelles(Brucelles) pour coton	29
BEALE , instruments à modeler	306	COLLER , pinces hémostatiques	10
Becs pour la laboratoire	159	COLLIER , porte-aiguilles	66
BEEBEE , ciseaux à couronnes	47, 48	COLLIN , marteaux	125
BEIN , elevateurs à racines	237	COLLIN , pinces tire-langue	148
BENNET , instruments pour plombages	298	COLUMBIA , curettes	255
BEYER , pinces-gouges	133	Combinaison bille/spatule	296
Bistouris	59-64	Compas	117, 118
Bistouris pour la gingivectomie	260, 261	CONVERSE , porte-aiguilles tungstène TUC	74
BLACK , ciseaux à émail	283	CONVERSE-DERF , porte-aiguilles	66
BLUMENTHAL , pinces-gouges	132	CORWIN , pinces à fil	312
BÖHLER , pinces-gouges	133	CORWIN , pinces à torsader le fil tungstène TUC	79
BÖHM , pinces pour couronnes télescopes	325	COUPLAND , canules d'aspiration	106, 108
Boîtes	153, 155, 156	COUPLAND , elevateurs à racines	233
Boîtes à instruments et pour la stérilisation et trays standard	347-362	Couteau à cire	308
Boîtes pour instruments	156	Couteau à plâtre	308
Boîtes pour stériliser des aiguilles	154	Couteaux à gencives	64
BOLEY , pied à coulisse	115	CRANE-KAPLAN , pinces pour cul-de-sac	32
Bouche / langue	139-150	CRILE , pinces hémostatiques	11
BOYNTON , porte-aiguilles	66	CRILE-RANKIN , pinces hémostatiques	11
BOYNTON , porte-aiguilles tungstène TUC	77	CRILE-WOOD , porte-aiguilles	68
BREWER , pince porte crampons	338	CRILE-WOOD , porte-aiguilles tungstène TUC	75
BRODIE , sondes	104	CRILE-WOOD-BABY , porte-aiguilles	68
BROPHY(SULLIVAN) , ciseaux fins	43	CRILE-WOOD-BABY , porte-aiguilles tungstène TUC	75
BROWN-ADSON , pinces à griffes	21	Crochet à dent de sagesse	138
Broyer d'os	345	Crochets très fins	90-93
Brucelles pour coton	29-31	CROWN-REMOVER , instruments de couronnes	310
BRUENINGS , abaisse-langues	147	CRYSER , daviers modèle americaine	218, 220, 221
BRUNS , curettes tranchantes	127	CRYSER , elevateurs à racines	228
Burins de paradontie	262	CUMINE , instruments à détartre	251
BYRD , canules d'aspiration	106	Curettes	255, 256
		Curettes tranchantes	127-129
		CUSHING , pinces à dissection et à griffes	23
		CUSHING , pinces à dissection tungstène TUC	28
		CUSHING-TAYLOR , pinces à dissection tungstène TUC	28
C			
Calibre à ressort	116		
Calibres	114, 115		
Calibres d'implantologie	344		
Canules d'aspiration	106-108		

	Page		Page
D			
DARBY-PERRY , excavateur	280	GILLIES , pinces à dissection tungstène TUC	27
Daviers à fragments des racines	203	GILLIES , porte-aiguilles	69
Daviers pour enfants, modèle américaine	223, 224	GILLIES , porte-aiguilles tungstène TUC	76
Daviers pour enfants, modèle anglaise	195-202	Gobelet dappen	158
Daviers, Elegance	187-194	GOLDMAN-FOX(SPECIAL) , ciseaux à gencives	49
Daviers, modèle américaine	205-224	GOLDMAN-FOX , bistouris pour la gingivectomie	260
Daviers, modèle anglaise	161-204	GOLDMAN-FOX , ciseaux à gencives	49
DAVIS-BOYLE , ouvre-bouches	143	GOLDMAN-FOX , ciseaux tungstène TUC	57
DE BAKEY , pinces atrauma	26	GOLDMAN-FOX , instruments à détartre	259
DE BAKEY , porte-aiguilles tungstène TUC	73	GOLDSTEIN , instruments pour composites	302
DEAN , ciseaux à gencives	49	GOSLEE , pinces plates, rondes	324
DEAN , ciseaux tungstène TUC	58	GRACEY STANDARD , curettes	256
DEAN-DELICATE , ciseaux à gencives	49	GRAEFE , ciseaux oculaires	45
DELICATE-DEAN , ciseaux à gencives	49	GRAZIL , ciseaux à chirurgie	37
DELICATE-MAYO-HEGAR , porte-aiguilles tungstène TUC	73	GREEN-SENN , écarteurs fins	92
DELICATE-METZENBAUM , ciseaux à dissection	41	GRITMANN , couteau à plâtre	308
DELICATE-METZENBAUM , ciseaux tungstène TUC	56	GROSS-MAIER , pinces à pansements	87
DELICATE-TOENNIS-ADSON , ciseaux tungstène TUC	57	GUTHRIE , crochets très fins	91
DENHART , ouvre-bouches	141		
DERF , porte-aiguilles	66	H	
DERF , porte-aiguilles tungstène TUC	74	HAJEK , marteaux	125
DERF-CONVERSE , porte-aiguilles	66	HAJEK-KOFFLER , pinces pour sinus sphénoïdal	137
DESMARRES , crochets très fins	93	HALSEY , porte-aiguilles	67
DINGMANN , ouvre-bouches	143	HALSEY , porte-aiguilles tungstène TUC	74
Dissecteurs	148	HALSTED , pinces hémostatiques	10
Distributeur à coton	158	HALSTED-MOSQUITO , pinces hémostatiques	9
Doigtiers	140	HARRIS , daviers modèle américaine	212
DOUGLAS , trocarts	105	HARRISON (PYE-SMITH) , pinces à stérilisation	157
DOYEN , porte-aiguilles	66	HARTMANN , abaisse-langues	146
DOYEN , sondes	103	HARTMANN , pinces hémostatiques	8
DUMONT , pinces plates, rondes	322	HARVEY , ciseaux pour fils	47
		HEGAR-MAYO , porte-aiguilles tungstène TUC	73
E		HEGAR-MAYO-DELICATE , porte-aiguilles tungstène TUC	73
Ecarteurs	89-100	HEGAR-OLSEN , porte-aiguilles	69
Ecarteurs des joues et des lèvres	146, 147	HEGAR-OLSEN , porte-aiguilles tungstène TUC	75
Ecarteurs des lèvres et des joues	146, 147	HEGAR-OLSEN-USA , porte-aiguilles tungstène TUC	75
Ecarteurs fins	92	HEIDBRINK , elevateurs à racines	245, 247
Ecarteurs pour parties molles	94, 95	HEIDEMANN , instruments pour plombages	291
Ecarteurs pour ramus	96	HEISTER , ouvre-bouches	140
EISELSBERG , ciseaux à ligatures	46	HEMINGWAY , curettes tranchantes	129
Elevateurs à racines	225-248	HENAHAN , crochet à dent de sagesse	138
ENGL.MODELL , pinces à champs	14	HILGER , miroirs à bouche	150
Etendeur	273	HOKE , ostéotomes	121
EWALD , pinces à dissection et à griffes	21	HOLLENBACK , instruments à modeler	305
Excavateurs	275-280	HOLLENBACK , instruments pour plombages	287
Extracteurs de couronne	309	HOLLOW-CHOP , pinces plates, rondes	322
		HOW , pinces à ligature	318
F		HYGIENIST , instruments à détartre	252
FAHNENSTOCK , couteau à cire	308	HYLIN , elevateurs à racines	236
FARABEUF , écarteurs	99	HYLIN , instruments à modeler	306
FARREL , porte-coton	104		
FELT , instruments pour composites	302	I	
FLAGG , précelles (brucelles) pour coton	30	Implantologie	339-346
FLOHR , elevateurs à racines	227	Instruments à amalgame	299
Fouloir à canaux	273	Instruments à détartre	249-252, 259
FOX-GOLDMAN(SPECIAL) , ciseaux à gencives	49	Instruments à l'os	119-138
FOX-GOLDMAN , ciseaux à gencives	49	Instruments à modeler	305-308
FOX-GOLDMAN , ciseaux tungstène TUC	57	Instruments de couronnes	309, 310
FRAHM , instruments à modeler	305	Instruments pour composites	302
Fraises trépan	344	Instruments pour mesurer	111-118
FRAZIER , canules d'aspiration	106	Instruments pour plombages	285-302
FRENZEL , abaisse-langues	147	IVORY , pince porte crampons	338
FRIEDMAN , elevateurs à racines	234	IVORY , pistolet pour amalgame	299
FRIEDMAN , pinces-gouges	131	IVORY , porte matrices	335, 336
		IWANSON , calibre à ressort	116
G			
GERALD , pinces à dissection et à griffes	23	J	
		JACOBSON , micro-porte-aiguilles	83
		JACOBSON , micro-porte-aiguilles tungstène TUC	80
		JAMESON , pied à coulisse	114
		JANSEN , curettes tranchantes	128
		JAPAN-TOHOKU , pinces à champs	15

	Page		Page
JENNINGS , ouvre-bouches	141	Marteaux	125, 126
JEWELER , pinces à dissection tungstène TUC	27	MARTINI , curettes tranchantes	128
JONES , pinces à champs	14	MATHIEU , porte-aiguilles	69
JOSEPH , ciseaux à dissection	42	MATHIEU , porte-aiguilles tungstène TUC	76
JOSEPH , crochets très fins	91	MATHIEU-DELICATE , porte-aiguilles	69
		MATHIEU-DELICATE , porte-aiguilles tungstène TUC	76
K		Matrices	333-338
KAPLAN-CRANE , pinces pour cul-de-sac	32	MAUNDER , baïllons	140
KAYE , ciseaux pour Face-lift	57	MAYFIELD , pinces-gouges	132
KELLS , daviers modèle américaine	222	MAYO , abaisse-langues	147
KELLY , ciseaux	38	MAYO , ciseaux	38
KELLY , ciseaux tungstène TUC	54	MAYO , clips de stérilisation	157
KELLY , pinces hémostatiques	10	MAYO-HEGAR , porte-aiguilles	68
KELLY-RANKIN , pinces hémostatiques	10	MAYO-HEGAR , porte-aiguilles tungstène TUC	73
KERRISON , pinces pour sinus sphénoïdal	137	MAYO-HEGAR-DELICATE , porte-aiguilles	68
KILNER(RAGNELL) , ciseaux à dissection	42	MAYO-HEGAR-DELICATE , porte-aiguilles tungstène TUC	73
KILNER , porte-aiguilles	67	McINDOE , pinces à dissection	21
KILNER , porte-aiguilles tungstène TUC	74	McIVOR , ouvre-bouches	144
KILNER-DOUGHTY , ouvre-bouches	142	McCALL , curettes	255
KIRKLAND , bistouris pour la gingivectomie	261	McCALL , instruments à détartrer	251
KLEIN , daviers pour enfants, modèle anglaise	199, 201, 202	McKESSON , baïllons	145
KLEINERT-KUTZ , pinces-gouges	133	MEAD , daviers modèle anglaise	186
KNAPP , crochets très fins	91	MEAD , marteaux	126
KOCHER-DELICATE , pinces hémostatiques	13	MEAD , pinces-gouges	132
KOCHER-LANGENBECK , écarteurs	98	MERIAM , précelles (brucelles) pour coton	30
KOCHER-OCHSNER , pinces hémostatiques	12	MERSHON , ajusteur de bande	309
KRAUSE , trocars	105	Mesures graduées	153
KROENIG , abaisse-langues	147	METZENBAUM , ciseaux à dissection	39
		METZENBAUM , ciseaux tungstène TUC	55
L		METZENBAUM , porte-aiguilles tungstène TUC	77
LA GRANGE , ciseaux oculaires	45	METZENBAUM-BABY , ciseaux à dissection	39
Lames de bistouris	62, 63	METZENBAUM-DELICATE , ciseaux à dissection	41
LANDGRAF , précelles (brucelles) pour coton	31	METZENBAUM-DELICATE , ciseaux tungstène TUC	56
LANGENBECK , doigtiers	140	METZENBAUM-NELSON , ciseaux à dissection	40
LANGENBECK , écarteurs	97	MEYERDING , écarteurs fins	92
LANGENBECK , porte-aiguilles	70	MICRO-ADSON , pinces à dissection et à griffes	20
LANGENBECK , porte-aiguilles tungstène TUC	78	Micro-ciseaux	51, 52
LANGENBECK-DELICATE , porte-aiguilles tungstène TUC	78	MICRO-FRIEDMANN , pinces-gouges	135
LANGENBECK-KOCHER , écarteurs	98	MICRO-MOSQUITO , pinces hémostatiques	9
LANGENBECK-MINI , écarteurs fins	92	Micro-porte-aiguilles	81-83
LANGENBECK-RYDER , porte-aiguilles tungstène TUC	78	Micro-porte-aiguilles à manches rondes	81, 82
LAWRENCE-READ , daviers modèle anglaise	179	Micro-porte-aiguilles tungstène TUC	80
LE CRON , instruments à modeler	306	MIDDELDORPF , écarteurs	99
LECLUSE , elevateurs à racines	240	MILLER , pinces pour papier à articulation	32
LICHTENBERG , porte-aiguilles tungstène TUC	77	MILLER-APEXO , elevateurs à racines	235
LICHTENSTEIN , couteau à plâtre	308	MILLER-COLBURN , limes à os	265, 266
LICHTWITZ , trocars	105	MINI , lames de bistouris	62
Limes à os	265-267	MINI , manches de bistouris	62
LINDO LEVIAN , elevateurs à racines	235	MINI-FRIEDMAN , pinces-gouges	131
LISTER , ciseaux tungstène TUC	58	MINI-LANGENBECK , écarteurs fins	92
LISTER , pinces à tampons	87	MINI-LEXER , ciseaux-burins	124
LITTAUER , ciseaux à ligatures	46	MINI-LEXER , ostéotomes	124
LITTAUER-LISTON , pinces coupantes à os	136	Mirroirs à bouche	150
LOCKHART-MUMMERY , sondes	104	MITCHELL , instruments à détartrer	251
LOCKLIN , ciseaux à gencives	49	MOD.WÜRZBURG , ouvre-bouches	144
LOCKLIN , ciseaux tungstène TUC	58	MOLT , ouvre-bouches	140
LONDON COLLEGE , précelles (brucelles) pour coton	29	MOLT , rugines-raspatoires	130, 263
LORNA , pinces à champs	15	MORITZ-SCHMIDT , abaisse-langues	146
LOTH-SCHOEMAKER , ciseaux à ligatures	46	MOSQUITO-HALSTED , pinces hémostatiques	9
LUCAE , marteaux	126	MOSQUITO-MICRO , pinces hémostatiques	9
LUCAS , ciseaux-burins	121	MUMMERY-LOCKHART , sondes	104
LUCAS , curettes tranchantes	129	MYRTLE LEAF , sondes	103
LUER , canules d'aspiration	107		
LUER , pinces-gouges	132	N	
LUNIATSCHECK , dissecteurs	148	NANCE , pince coupeur distale, pince pour technique	319
		NANCE , pinces à courber agrafes	320
M		NEGUS , support contre-poitrine pour ouvre-bouches	144
MAIER-GROSS , pinces à pansements	87	NEIVERT , porte-aiguilles	67
Manches pou miroirs à bouche	149	NEIVERT , porte-aiguilles tungstène TUC	74
Manches pour bistouris	61, 62	NELATON , sondes	103
		NELSON-METZENBAUM , ciseaux à dissection	40
		NEUMANN , ciseaux à gencives	50
		NEVIUS , daviers modèle américaine	217
		NOYES , ciseaux à iridectomie	51

	Page		Page
O			
Obturbateur a bille	295	Porte-aiguilles	66-70
Obturbateur plan	289	Porte-aiguilles tungstène TUC	73-78
OBWEGESER , écarteurs pour parties molles	94, 95	Porte-coton	104
OBWEGESER , écarteurs pour ramus	96	Portes empreintes	327-330
OCHSENBEIN , burins de paradontie	262	Portes empreintes partiels	331, 332
OCHSNER-KOCHER , pinces hémostatiques	12	Porte-serviettes	157
OEHLER , pinces à dissection tungstène TUC	27	POTT , elevateurs à racines	241
OHL , rugines-raspatoires	264	POTTS-SMITH , pinces à dissection tungstène TUC	27
OLSEN-HEGAR , porte-aiguilles	69	PRATT , sonde fistulaire	104
OLSEN-HEGAR , porte-aiguilles tungstène TUC	75	Précélles (brucelles) pour coton	29-31
OLSEN-HEGAR-USA , porte-aiguilles tungstène TUC	75	PRICHARD , rugines-raspatoires	263
OMS , sondes paradontales	274	Prothese et orthodontie	303-332
ORBAN , bistouris pour la gingivectomie	261	PYE-SMITH (HARRISON) , pinces à stérilisation	157
Ostéotomes	121-124		
P		Q	
Panier d'acier poinçonné	362	QUINBY , ciseaux à gencives	50
Paradontologie	253-268		
PARKER , écarteurs	99	R	
PARMILY , daviers modèle americaine	214	RAGNELL(KILNER) , ciseaux à dissection	42
PARTSCH , ciseaux-burins	123	RALK , pinces à échardes	25
PARTSCH , marteaux	126	RANKIN-CRILE , pinces hémostatiques	11
PEAN , pinces à saisir	8	RANKIN-KELLY , pinces hémostatiques	10
PEAN-DELICATE , pinces hémostatiques	13	Réceptifs cylindriques	156
PEAN-ROCHESTER , pinces hémostatiques	11	REILL , micro-porte-aiguilles	81
PEERS , pinces à champs	15	Releveur de couronne	309
PEET , pinces à échardes	25	REYNOLDS , ciseaux à dissection	42
PERRY , précélles (brucelles) pour coton	31	ROCHESTER-PEAN , pinces hémostatiques	11
Pied à coulisse	114, 115	ROEDER , pinces à champs	15
PIERCE , trocars	105	ROGGE , pinces à stérilisation	157
Pince coupeur distale	319	ROLLET , crochets très fins	91
Pincés	17-32	ROSER-KÖNIG , ouvre-bouches	141
Pincés à champs	14, 15	ROUX , écarteurs	99
Pincés à compresses	14, 15	Rugines-raspatoires	130, 263, 264
Pincés à courber agrafes	320	RUSKIN , pinces-gouges	134
Pincés à courber fils	321	RUSKIN-MINI , pinces-gouges	133
Pincés à courber les branches	315, 316		
Pincés à dissection et à griffes	19-23	S	
Pincés à dissection tungstène TUC	27, 28	SANVENERO , ciseaux à dissection	42
Pincés à échardes	24, 25	SCHAEDEL , pinces à champs	14
Pincés à éponges	87	SCHEDÉ , curettes tranchantes	127
Pincés à fil	311-314	SCHOEMAKER-LOTH , ciseaux à ligatures	46
Pincés à ligature	318	SCHUKNECHT , ciseaux pour fils	47
Pincés à pansements	85-88	SCHWARZ , pinces à courber agrafes	320
Pincés à perforer	338	SCHWARZ , pinces à courber fils	321
Pincés à saisir	8	SCHWARZ , pinces à courber les branches	315
Pincés à stérilisation	157	SECCO , manches pour miroirs à bouche	149
Pincés à tampons	87	SEEMANN-SEIFFERT , ouvre-bouches	141
Pincés à torsader le fil tungstène TUC	79	SELDIN , elevateurs à racines	231
Pincés atrauma	26	SELDIN , rugines-raspatoires	263
Pincés coupantes à os	136	SEMKEN , pinces à dissection tungstène TUC	27
Pincés hémostatiques	8, 9-13	SENN-GREEN , écarteurs fins	92
Pincés hémostatiques graciles	13	Seringue à os	342, 343
Pincés plates	313	Seringue d'application	341
Pincés plates, rondes	322-324	Seringues à ampoule	109
Pincés porte crampons	338	SILVER-POINT , pince	25
Pincés pour couronnes télescopes	325	SIMPLEX , écarteurs des joues	146
Pincés pour cul-de-sac	32	SMITH , ciseaux pour fils	47
Pincés pour papier à articulat	32	Sonde dentaire	271, 272
Pincés pour sinus sphénoïdal	137	Sonde fistulaire	104
Pincés pour suture	31	Sondes	103, 104
Pincés pour technique	319	Sondes	269-274
Pincés tire-langue	148	Sondes et aiguilles spéciales	101-110
Pincés universelles	317	Sondes paradontales	274
Pincés-gouges	131-135	Spatule	297
Pistolet pour amalgame	299	Spatule à plâtre	300, 301
PITHA , baïllons	140	SPENCER , ciseaux à ligatures	46
Plaque de verre à brassage	158	SPENCER-DELICATE , ciseaux à ligatures	46
Plateau pour déposer instruments	361	SPRATT , curettes tranchantes	127
Plateaux pour instruments	155	STACKE , sondes	103
Porte matrices et matrices	335-337	STANDARD , abaisse-langues	147
		STANDARD , ciseaux à chirurgie	36
		STANDARD , ciseaux à gencives	50

	Page		Page
STANDARD , pinces à dissection et à griffes	19	WINTER , elevateurs à racines	243
STELLBRINK , pinces-gouges	131	WITZEL , daviers à fragments des racines	203
STERNBERG , écarteurs des joues et des lèvres	146	WOODSON , instruments pour plombages	292
STERNUM , pinces à fil	312	WOODWARD , daviers modèle americaine	209
STERNUM , pinces à torsader le fil tungstène TUC	79	WYNMAN , pince a couronne	310
STEVENS , ciseaux à ténatomie	45		
STEVENS , ciseaux tungstène TUC	57	Y	
STIEGLITZ , pinces à échardes	25	YOUNG , pinces à courber fils	321
STOCKES , pince porte crampons	338	YOUNG , pinces tire-langue	148
SULLIVAN(BROPHY) , ciseaux fins	43	YOUNGER-GOOD , instruments à détartrer	251
SULLIVAN , ciseaux à gencives	50		
Super Cut ciseaux	35	Z	
Support contre-poitrine pour ouvre-bouches	144	ZAUFAL-JANSEN , pinces-gouges	134
Suture	65-84		
T			
TAYLOR , pinces à dissection et à griffes	22		
TAYLOR-CUSHING , pinces à dissection tungstène TUC	28		
TERRIER , pinces hémostatiques	8		
THIESS , marteaux	126		
THOMAS , instruments à modeler	307		
TOBOLD , abaisse-langues	146		
TOENNIS , porte-aiguilles	70		
TOENNIS , porte-aiguilles tungstène TUC	77		
TOENNIS-ADSON-DELICATE , ciseaux tungstène TUC	57		
TOFFLEMIRE , matrices	337		
TOFFLEMIRE-UNIVERSAL , porte matrices	337		
TOHOKU-JAPAN , pinces à champs	15		
TOMES , daviers modèle americaine	216		
TOWNER , instruments à détartrer	251		
TOWNLEY , pied à coulisse	114		
Trays standard et accessoires	353-362		
TREYMANN , extracteurs de couronne	309		
Trocarts	105		
U			
UNIV.MINNESOTA , abaisse-langues	147		
UNIVERSAL , ciseaux pour fils	47		
UNIVERSAL , ciseaux tungstène TUC	58		
UNIVERSAL , pinces universelles	317		
UNIVERSAL , pinces-gouges	131		
USA , instruments pour plombages	291		
USA , pince à perforer	338		
V			
VERNIER , calibres	114, 115		
VOLKMANN , curettes tranchantes	127		
W			
W.F. BARRY , elevateurs à racines	242		
WAGNER , ciseaux fins à chirurgie	43		
WALDSACHS , pinces universelles	317		
WALTON , pinces à pansements	88		
WARD , instruments à modeler	305		
WARWICK-JAMES , elevateurs à racines	241		
WEBSTER , porte-aiguilles	67		
WEBSTER , porte-aiguilles tungstène TUC	74		
WECKER , ciseaux à iridectomie	51		
WEDELSTAEDT , ciseaux à émail	284		
WEINGART , pinces à ligature	318		
WEST , elevateurs à racines	248		
WEST , rugines-raspatoires	264		
WESTCOTT , ciseaux à ténatomie	52		
WESTCOTT , micro-ciseaux	52		
WHITE , excavateurs	278		
WHITEHEAD , ouvre-bouches	142		
WHO , sondes paradontales	274		
WIEDER , abaisse-langues	146		
WILLIGER , curettes tranchantes	128		
WILLIGER , rugines-raspatoires	130		
WILMER , ciseaux oculaires	45		

Indice alfabetico

	Pagina		Pagina
A			
Abbassalingua	146, 147	CARROLL , portaghi	68
Ablatore di tartaro	259	CASTROVIEJO , circolo	117
Accessorio in plastica	299	CASTROVIEJO , forbici per cornea	51
ADAMS , pinza per tagliare filo,-tecnica per filo con scanalatura	319	CASTROVIEJO , forbici per iridectomia	51
ADAMS , porta salviette	157	CASTROVIEJO , micro-portaghi	83
ADERER , pinza per tagliare filo,-tecnica per filo con scanalatura	319	CASTROVIEJO , micro-portaghi tungsteno TUC	80
ADERER , tenaglie per la piegatura di fili metallici	321	CASTROVIEJO-EPKER , circolo	118
ADERER , tenaglie per la piegatura di graffe	320	Cesoie per ossa	136
ADSON , pinze anatomiche e chirurgiche	20, 21	Cestello in acciaio perforato	362
ADSON , pinze tungsteno TUC	28	CHADWICK , forbici oftalmologiche	45
ADSON-BABY , pinze per preparazioni e legature	13	CHEATLE , pinze per sterilizzazione	157
ADSON-BROWN , pinze anatomiche e chirurgiche	21	CHOMPRET , elevatori per radici	244
ADSON-MICRO , pinze anatomiche e chirurgiche	20	CLEVELAND , cesoie per ossa	136
ADSON-TOENNIS-DELICATE , forbici tungsteno TUC	57	CLEVELAND , pinze-sgorbie	131
AINSWORTH , pinze foradiga	338	CLEVELAND-GARDNER , cesoie per ossa	136
ALEXANDER , scalpelli	122	COAKLEY , trequarti	105
ANGLE , pinza per tagliare filo,-tecnica per filo con scanalatura	319	COGSWELL , cannule per aspirazione	107
ANGLE , tenaglie per la piegatura di fili metallici	321	COLEMAN , elevatori per radici	232
APICAL , elevatori per radici	229, 230	COLLEGE-LONDON , pinze per cotone	29
Apribocca	140-145	COLLER , pinze emostatiche	10
ARRUGA , portaghi	66	COLLIER , portaghi	66
ARRUGA , portaghi tungsteno TUC	77	COLLIN , martelli	125
Articoli diversi	151-160	COLLIN , pinze tiralingua	148
Astucci per la sterilizzazione e bacinelle standard	347-362	Coltelli per gengive	64
B			
BABY-ADSON , pinze per preparazioni e legature	13	Coltello per gesso	308
BABY-CRILE-WOOD , portaghi	68	COLUMBIA , curette	255
BABY-CRILE-WOOD , portaghi tungsteno TUC	75	Combinazione sfera/spatola	296
Bacinella per il deposito degli strumenti	361	CONVERSE , portaghi tungsteno TUC	74
Bacinelle per strumenti	155	CONVERSE-DERF , portaghi	66
Bacinelle reniformi	153	CORWIN , pinze per ritorcere TUC	79
Bacinelle standard ed accessori	353-362	CORWIN , tenaglie fili	312
BACKHAUS , fissatele	14	COUPLAND , cannule per aspirazione	106, 108
BALL & SOCKET , pinze per fissare le compresse	15	COUPLAND , elevatori per radici	233
BEALE , strumenti per modellare	306	CRANLE-CAPLAN , pinze per marcazione	32
Becco del gas per laboratorio	159	CRILE , pinze emostatiche	11
BEEBEE , forbici per corone	47, 48	CRILE-RANKIN , pinze emostatiche	11
BEIN , elevatori per radici	237	CRILE-WOOD , portaghi	68
BENNET , otturatore	298	CRILE-WOOD , portaghi tungsteno TUC	75
BEYER , pinze-sgorbie	133	CRILE-WOOD-BABY , portaghi	68
Bicchieri graduati	153	CRILE-WOOD-BABY , portaghi tungsteno TUC	75
Bisturi	59-64	CROWN-REMOVER , strumenti per corone	310
Bisturi per gengivectomia	260, 261	CRYER , elevatori per radici	228
BLACK , tagliasmalto	283	CRYER , pinza per estrazione, modello americano	218, 220, 221
BLUMENTHAL , pinze-sgorbie	132	Cucchiaino portamalgame	299
BÖHLER , pinze-sgorbie	133	CUMINE , levartartari dentali	251
BÖHM , pinza telescopiche per coroni	325	Curette	255, 256
Bocca / lingua	139-150	Curette taglianti	127-129
BOLEY , calibratore	115	CUSHING , pinze anatomiche e chirurgiche	23
BOYNTON , portaghi	66	CUSHING , pinze tungsteno TUC	28
BOYNTON , portaghi tungsteno TUC	77	CUSHING-TAYLOR , pinze tungsteno TUC	28
BREWER , pinze per uncini	338	D	
BRODIE , sonda	104	DARBY-PERRY , scavatore	280
BROPHY(SULLIVAN) , forbici fine	43	DAVIS-BOYLE , apribocca	143
BROWN-ADSON , pinze anatomiche e chirurgiche	21	DE BAKEY , pinze atrauma	26
BRUENINGS , abbassalingua	147	DE BAKEY , portaghi tungsteno TUC	73
BRUNS , curette taglienti	127	DEAN , forbici per gengiva	49
Bussolotto dappen	158	DEAN , forbici tungsteno TUC	58
BYRD , cannule per aspirazione	106	DEAN-DELICATE , forbici per gengiva	49
C			
Calibratore	114, 115	DENHART , apribocca	141
Calibri per implantologia	344	DERF , portaghi	66
Cannule per aspirazione	106-108	DERF , portaghi tungsteno TUC	74
CARREL , pinze emostatiche	8	DERF-CONVERSE , portaghi	66
		DESMARRES , divaricatori sottili	93
		DINGMANN , apribocca	143
		Dispositivo di azionamento del nastro	309
		Dissettori	148
		Distributore di cotone	158
		Ditali	140

Divaricatori	89-100
Divaricatori per guance e labbra	146
Divaricatori per tessuti molli	94, 95
Divaricatori sottili	90-93
DOUGLAS , trequarti	105
DOYEN , portaghi	66
DOYEN , sonde	103
DUMONT , tenaglie piatte	322

E

EISELSBERG , forbici per legatura	46
Elevatori per radici	225-248
ENGL.MODELL , fissatele	14
Escavatori	275-280
Estensore	273
Estensore per corona	309
Estrattore per corona	309
EWALD , pinze anatomiche e chirurgiche	21

F

FAHNENSTOCK , coltello per gesso	308
FARABEUF , divaricatori	99
FARRELL , portacotone	104
FELT , strumenti composito	302
Fissatele	14, 15
FLAGG , pinze per cotone	30
FLOHR , elevatori per radici	227
Forbici	33-58
Forbici fine	43-45
Forbici micro	51, 52
Forbici oftalmologiche	45
Forbici per chirurgia	36-38
Forbici per corone	47, 48
Forbici per filo metallico	47
Forbici per gengiva	49, 50
Forbici per iridectomia	51
Forbici per legatura	46
Forbici per preparazioni	39-42
Forbici Super-Cut SC	35
Forbici tungsteno TUC	54-58
FOX-GOLDMAN SPEZIAL , forbici per gengiva	49
FOX-GOLDMAN , forbici per gengiva	49
FOX-GOLDMAN , forbici tungsteno TUC	57
FRAHM , strumenti per modellare	305
FRAZIER , cannule per aspirazione	106
FRENZEL , abbassalingua	147
Frese trephine	344
FRIEDMAN , elevatori per radici	234
FRIEDMAN , pinze-sgorbie	131

G

GERALD , pinze anatomiche e chirurgiche	23
GILLIES , pinze tungsteno TUC	27
GILLIES , portaghi	69
GILLIES , portaghi tungsteno TUC	76
GOLDMAN-FOX SPEZIAL , forbici per gengiva	49
GOLDMAN-FOX , ablatore di tartaro	259
GOLDMAN-FOX , bisturi per gengivectomia	260
GOLDMAN-FOX , forbici per gengiva	49
GOLDMAN-FOX , forbici tungsteno TUC	57
GOLDSTEIN , strumenti composito	302
GOSLEE , tenaglie piatte	324
GRACEY STANDARD , curette	256
GRAEFE , forbici oftalmologiche	45
GRAZIL , forbici per chirurgia	37
GREEN-SENN , divaricatori sottili	92
GRITMANN , coltello per gesso	308
GROSS-MAIER , pinze per polipi	87
GUTHRIE , divaricatori sottili	91

H

HAJEK , martelli	125
HAJEK-KOFFLER , pinze per seno sfenoidale	137
HALSEY , portaghi	67
HALSEY , portaghi tungsteno TUC	74
HALSTED , pinze emostatiche	10
HALSTED-MOSQUITO , pinze emostatiche	9
HARRIS , pinza per estrazione, modello americano	212
HARRISON (PYE-SMITH) , pinze per sterilizzazione	157
HARTMANN , abbassalingua	146
HARTMANN , pinze emostatiche	8
HARVEY , forbici per filo metallico	47
HEGAR-MAYO , portaghi	68
HEGAR-MAYO , portaghi tungsteno TUC	73
HEGAR-MAYO-DELICATE , portaghi	68
HEGAR-OLSEN , portaghi	69
HEGAR-OLSEN , portaghi tungsteno TUC	75
HEGAR-OLSEN-USA , portaghi tungsteno TUC	75
HEIDBRINK , elevatori per radici	245, 247
HEIDEMANN , otturatori	291
HEISTER , apribocca	140
HEMINGWAY , curette taglienti	129
HENAHAN , uncino per dente del giudizio	138
HILGER , specchietti	150
HOKE , osteotomi	121
HOLLENBACK , otturatori	287
HOLLENBACK , strumenti per modellare	305
HOLLOW-CHOP , tenaglie piatte	322
HOW , tenaglie per legatura	318
HYGIENIST , levatartari dentali	252
HYLIN , elevatori per radici	236
HYLIN , strumenti per modellare	306

I

Implantologia	339-346
IVORY , cucchiaino portamalgama	299
IVORY , pinze per uncini	338
IVORY , portamatrici	335, 336
IWANSON , compasso a molla	116

J

JACOBSON , micro-portaghi	81
JACOBSON , micro-portaghi tungsteno TUC	80
JAMESON , calibratore	114
JANSEN , curette taglienti	128
JENNINGS , apribocca	141
JEWELER , pinze tungsteno TUC	27
JONES , fissatele	14
JOSEPH , divaricatori sottili	91
JOSEPH , forbici per preparazioni	42

K

KAYE , forbici Face-lift	57
KELLS , pinza per estrazione, modello americano	222
KELLY , forbici per fistole	38
KELLY , forbici tungsteno TUC	54
KELLY , pinze emostatiche	10
KELLY-RANKIN , pinze emostatiche	10
KERRISON , pinze per seno sfenoidale	137
KILNER(RAGNELL) , forbici per preparazioni	42
KILNER , portaghi	67
KILNER , portaghi tungsteno TUC	74
KILNER-DOUGHTY , apribocca	142
KIRKLAND , bisturi per gengivectomia	261
KLEIN , pinza per estrazione per bambini modello inglese	199, 201, 202
KLEINERT-KUTZ , pinze-sgorbie	133
KNAPP , divaricatori sottili	91
KOCHER-DELICATE , pinze emostatiche	13
KOCHER-LANGENBECK , divaricatori	98
KOCHER-OCHSNER , pinze emostatiche	12
KRAUSE , trequarti	105

	Pagina		Pagina
KROENIG , abbassalingua	147	METZENBAUM , portaghi tungsteno TUC	77
L		METZENBAUM-BABY , forbici per preparazioni	39
LA GRANGE , forbici oftalmologice	45	METZENBAUM-DELICATE , forbici per preparazioni	41
Lame per bisturi	62, 63	METZENBAUM-DELICATE , forbici tungsteno TUC	56
LANDGRAF , pinze per cotone	31	METZENBAUM-NELSON , forbici per preparazioni	40
LANGENBECK , ditali	140	MEYERDING , divaricatori sottili	92
LANGENBECK , divaricatori	97	Micro forbici	51, 52
LANGENBECK , portaghi	70	Micro portaghi	81-83
LANGENBECK , portaghi tungsteno TUC	78	Micro portaghi con manici rotondi	81, 82
LANGENBECK-DELICATE , portaghi tungsteno TUC	78	Micro portaghi tungsteno TUC	80
LANGENBECK-KOCHER , divaricatori	98	MICRO-ADSON , pinze anatomiche e chirurgiche	20
LANGENBECK-MINI , divaricatori sottili	92	MICRO-FRIEDMANN , pinze-sgorbie	135
LANGENBECK-RYDER , portaghi tungsteno TUC	78	MICRO-MOSQUITO , pinze emostatiche	9
Lastra di vetro a mescolare	159	MIDDELDORPF , divaricatori	99
LAWRENCE-READ , pinza per estrazione modello inglese	179	MILLER , pinze per carta di articolazione	32
LE CRON , strumenti per modellare	306	MILLER-APEXO , elevatori per radici	235
LECLUSE , elevatori per radici	240	MILLER-COLBURN , lime e raspe per osso	265, 266
Levatartari dentali	249-252	MINI , lame per bisturi	62
tagli tungsteno TUC	77	MINI , manici per bisturi	62
LICHTENSTEIN , coltello per gesso	308	MINI-FRIEDMAN , pinze-sgorbie	131
LICHTWITZ , trequarti	105	MINI-LANGENBECK , divaricatori sottili	92
Lime e raspe per osso	265-267	MINI-LEXER , osteotomi	124
LINDO LEVIAN , elevatori per radici	235	MINI-LEXER , scalpelli	124
LISTER , forbici tungsteno TUC	58	MITCHELL , levatartari dentali	251
LISTER , pinze per spugne	87	MOD.WÜRZBURG , apribocca	144
LITTAUER , forbici per legatura	46	MOLT , apribocca	140
LITTAUER-LISTON , cesoie per ossa	136	MOLT , periostotomi	130, 263
LOCKHART-MUMMERY , sonde	104	MORITZ-SCHMIDT , abbassalingua	146
LOCKLIN , forbici per gengiva	49	MOSQUITO-HALSTED , pinze emostatiche	9
LOCKLIN , forbici tungsteno TUC	58	MOSQUITO-MICRO , pinze emostatiche	9
LONDON-COLLEGE , pinze per cotone	29	Mulino d'osso	345
LORNA , fissatele	15	MYRTLE-LEAF , sonda	103
LOTH-SCHOEMAKER , forbici per legatura	46	N	
LUCAE , martelli	126	NANCE , pinza per tagliare filo,-tecnica per filo con scanalatura	319
LUCAS , curette taglienti	129	NANCE , tenaglie per la piegatura di graffe	320
LUCAS , scalpelli	121	NEGUS , supporto contro-petto per apribocca	144
LUER , cannule per aspirazione	107	NEIVERT , portaghi	67
LUER , pinze-sgorbie	132	NEIVERT , portaghi tungsteno TUC	74
LUNIATSCHECK , dissestori	148	NELATON , sonde	103
M		NELSON-METZENBAUM , forbici per preparazioni	40
MAIER-GROSS , pinze per polipi	87	NEUMANN , forbici per gengiva	50
Manici per bisturi	61, 62	NEVIUS , pinza per estrazione, modello americano	217
Manici per specchietti	149	NOYES , forbici per iridectomia	51
Martelli	125, 126	O	
MARTINI , curette taglienti	128	OBWEGESER , divaricatori per tessuti molli	94, 95
MATHIEU , portaghi	69	OBWEGESER , separatore per ramo	96
MATHIEU , portaghi tungsteno TUC	76	OCHSENBEIN , sgorbie per parodontologia	262
MATHIEU-DELICATE , portaghi	69	OCHSNER-KOCHER , pinze emostatiche	12
MATHIEU-DELICATE , portaghi tungsteno TUC	76	OEHLER , pinze tungsteno TUC	27
Matrici	333-338	OHL , Periostotomi	264
MAUNDER , apribocca	140	OLSEN-HEGAR , portaghi	69
MAYFIELD , pinze-sgorbie	132	OLSEN-HEGAR , portaghi tungsteno TUC	75
MAYO , abbassalingua	147	OLSEN-HEGAR-USA , portaghi tungsteno TUC	75
MAYO , forbici	38	OMS , sonda parodontale	274
MAYO , pinze per sterilizzazione	157	ORBAN , bisturi per gengivectomia	261
MAYO-HEGAR , portaghi	68	Osteotomi	121-124
MAYO-HEGAR , portaghi tungsteno TUC	73	Otturatore	273
MAYO-HEGAR-DELICATE , portaghi	68	Otturatore a sfera	295
MAYO-HEGAR-DELICATE , portaghi tungsteno TUC	73	Otturatore piano	289
McINDOE , pinze anatomiche e chirurgiche	21	Otturatori	285-302
McIVOR , apribocca	144	P	
McCALL , curette	255	Paradontologia	253-268
McCALL , levatartari dentali	251	PARKER , divaricatori	99
McKESSON , apribocca	145	PARMILY , pinza per estrazione, modello americano	214
MEAD , martelli	126	PARTSCH , martelli	126
MEAD , pinza per estrazione modello inglese	186	PARTSCH , scalpelli	123
MEAD , pinze-sgorbie	132	PEAN , pinze per afferrare	8
MERIAM , pinze per cotone	30	PEAN-DELICATE , pinze emostatiche	13
MERSHON , dispositivo di azionamento del nastro	309	PEAN-ROCHESTER , pinze emostatiche	11
METZENBAUM , forbici per preparazioni	39		
METZENBAUM , forbici tungsteno TUC	55		

PEERS , fissatele	15
PEET , pinze per schegge	25
Periostotomi	130, 263, 264
PERRY , pinze per cotone	31
PIERCE , trequarti	105
Pinza per tagliare filo	319
Pinza tecnica per filo con scanalatura	319
Pinza telescopiche per coroni	325
Pinze	17-32
Pinze anatomiche e chirurgiche	19-23
Pinze atrauma	26
Pinze emostatiche	8, 9-13
Pinze foradiga	338
Pinze per afferrare	8
Pinze per afferrare tessuti	8
Pinze per atrauma	26
Pinze per carta di articolazione	32
Pinze per cotone	29-31
Pinze per estrazione per bambini, modello americano	223, 224
Pinze per estrazione per bambini, modello inglese	195-202
Pinze per estrazione, Elegance	187-194
Pinze per estrazione, modello americano	205-224
Pinze per estrazione, modello inglese	161-204
Pinze per fissare le compresse	15
Pinze per marcazione	32
Pinze per polipi	85-88
Pinze per preparazioni e legature	13
Pinze per radici e fragmenti	203
Pinze per ritorcere fili TUC	79
Pinze per schegge	24, 25
Pinze per seno sfenoidale	137
Pinze per spugne	87
Pinze per sterilizzazione	157
Pinze per sutura	31
Pinze per uncini	338
Pinze tiralingua	148
Pinze tungsteno TUC	27, 28
Pinze-forbici per cornea	51
Pinze-sgorbie	131-135
PITHA , apribocca	140
Porta salviette	157
Portacotone	104
Portaghi	66-70
Portaghi micro	81-83
Portaghi tungsteno TUC	73-78
Portaimpronte	327-330
Portaimpronte parziali	331, 332
Portamatrici e matrici	335-337
POTT , elevatori per radici	241
POTTS-SMITH , pinze tungsteno TUC	27
PRATT , sonda per fistule	104
PRICHARD , Peristotomi	263
Protesi e ortodonzia	303-332
PYE-SMITH (HARRISON) , pinze per sterilizzazione	157

Q

QUINBY , forbici per gengiva	50
-------------------------------------	----

R

RAGNELL(KILNER) , forbici per preparazioni	42
RALK , pinze per schegge	25
RANKIN-CRILE , pinze emostatiche	11
RANKIN-KELLY , pinze emostatiche	10
Recipienti cilindrici	156
REILL , micro-portaghi	80
REYNOLDS , forbici per preparazioni	42
ROCHESTER-PEAN , pinze emostatiche	11
ROEDER , fissatele	15
ROGGE , pinze per sterilizzazione	157
ROLLET , divaricatori sottile	91
ROSER-KÖNIG , apribocca	141
ROUX , divaricatori	99
RUSKIN , pinze-sgorbie	134

RUSKIN-MINI , pinze-sgorbie	133
------------------------------------	-----

S

SANVENERO , forbici per preparazioni	42
Scalpelli	121-124
Scatole per sterilizzare aghi	154
Scatole per strumenti	156
SCHAEDEL , fissatele	14
SCHEDÉ , curette taglienti	127
SCHOEMAKER-LOTH , forbici per legatura	46
SCHUKNECHT , forbici per filo metallico	47
SCHWARZ , tenaglie per la piegatura di fili metallici	321
SCHWARZ , tenaglie per la piegatura di graffe	320
SCHWARZ , tenaglie per la piegatura di staffe	315
SECCO , manici per specchietti	149
SEEMANN-SEIFFERT , apribocca	141
SELDIN , elevatori per radici	231
SELDIN , Peristotomi	263
SEMKEN , pinze anatomiche e chirurgiche	21, 22
SEMKEN , pinze tungsteno TUC	27
SENN-GREEN , divaricatori sottili	92
Separatore per ramo	96
Sgorbie per parodontologia	262
SILVER-POINT , pinza	25
SIMPLEX , divaricatori per guance	146
Siringa di applicazione	341
Siringhe ampollari	109
Siringhe per osso	342, 343
SMITH , forbici per filo metallico	47
Sonda dentale	271, 272
Sonda parodontale	274
Sonda per fistule	104
Sonde	103, 104
Sonde	269-274
Sonde e aghi speciali	101-110
Spatola	297
Spatola per cemento	300, 301
Specchietti	150
SPENCER , forbici per legatura	46
SPENCER-DELICATE , forbici per legatura	46
SPRATT , curette taglienti	127
STACKE , sonde	103
STANDARD , abbassalingua	147
STANDARD , forbici per chirurgia	36
STANDARD , forbici per gengiva	50
STANDARD , pinze anatomiche e chirurgiche	19
STANDARD , pinze anatomiche e chirurgiche	19
STELLBRINK , pinze-sgorbie	131
STERNBERG , divaricatori per guance e labbra	146
STERNUM , portaghi tungsteno TUC	79
STERNUM , tenaglie fili	312
STEVENS , forbici oftalmologice	45
STEVENS , forbici tungsteno TUC	57
STIEGLITZ , pinze per schegge	25
STOCKES , pinze per uncini	338
Strumenti composito	302
Strumenti per amalgama	299
Strumenti per corone	309, 310
Strumenti per misurare	111-118
Strumenti per modellare	305-308
Strumenti per osso	119-138
SULLIVAN , forbici per gengiva	50
Super Cut forbici	35
Supporto contro-petto per apribocca	144
Sutura	65-84

T

Tagliasmalto	281-284
TAYLOR , pinze anatomiche e chirurgiche	22
TAYLOR-CUSHING , pinze tungsteno TUC	28

	Pagina		Pagina
Tenaglie fili	311-314	Z	
Tenaglie per la piegatura di fili metallici	321	ZAHLE , strumenti per modellare	306
Tenaglie per la piegatura di graffe	320	ZAUFAL-JANSEN , pinze-sgorbie	134
Tenaglie per la piegatura di staffe	315, 316		
Tenaglie per legatura	318		
Tenaglie piatte	313		
Tenaglie piatte	322-324		
Tenaglie universali	317		
TERRIER , pinze emostatiche	8		
THIESS , martelli	126		
THOMAS , strumenti per modellare	307		
TOBOLD , abbassalingua	146		
TOENNIS , portaghi	70		
TOENNIS , portaghi tungsteno TUC	77		
TOENNIS-ADSON-DELICATE , forbici tungsteno TUC	57		
TOFFLEMIRE , matrici	337		
TOFFLEMIRE-UNIVERSAL , portamatrici	337		
TOHOKU-JAPAN , fissatele	15		
TOMES , pinza per estrazione, modello americano	216		
TOWNER , levatartari dentali	251		
TOWNLEY , calibratore	114		
Trequarti	105		
TREYMANN , estrattore per corona	309		
U			
Uncino per dente del giudizio	138		
UNIV.MINNESOTA , abbassalingua	147		
UNIVERSAL , forbici per filo metallico	47		
UNIVERSAL , forbici tungsteno TUC	58		
UNIVERSAL , pinze-sgorbie	131		
UNIVERSAL , tenaglie universali	317		
USA , otturatori	291		
USA , pinze foradiga	338		
V			
VERNIER , calibratore	114, 115		
VOLKMANN , curette taglienti	127		
W			
W.F. BARRY , elevatori per radici	242		
WAGNER , forbici fine	43		
WALDSACHS , tenaglie universali	317		
WALTON , pinze per polipi	88		
WARD , strumenti per modellare	305		
WARWICK-JAMES , elevatori per radici	241		
WEBSTER , portaghi	67		
WEBSTER , portaghi tungsteno TUC	74		
WECKER , forbici per iridectomia	51		
WEDELSTAEDT , tagliasmalto	284		
WEINGART , tenaglie per legatura	318		
WEST , elevatori per radici	248		
WEST , peristotomi	264		
WESTCOTT , forbici micro	52		
WHITE , escavatori	278		
WHITEHEAD , apribocca	142		
WHO , sonda parodontale	274		
WIEDER , abbassalingua	146		
WILLIGER , curette taglienti	128		
WILLIGER , peristotomi	130		
WILMER , forbici oftalmologice	45		
WINTER , elevatori per radici	243		
WITZEL , pinze per radici e fragmenti	203		
WOODSON , otturatori	292		
WOODWARD , pinza per estrazione, modello americano	209		
WYNMAN , tenaglia corona	310		
Y			
YOUNG , pinze tirlingua	148		
YOUNG , tenaglie per la piegatura di fili metallici	321		
YOUNGER-GOOD , levatartari dentali	251		

nopa[®] instruments

nopa **instruments**

Medizintechnik GmbH

Weilatten 7-9

D - 78532 Tuttlingen

Tel. +49.7462.9490-0

Fax +49.7462.9490-90

info@nopa.de

www.nopa.de

Herstellung und Verkauf chirurgischer
und endoskopischer Instrumente.

Manufacture and Sales of Surgical
and Endoscopic Instruments.

