

---

ophthalmologie

ophthalmology

oftalmología

ophthalmologie

oftalmologia

nopa<sup>®</sup> instruments





Dies ist unser Katalog, er bleibt unser ausschließliches Eigentum. Es gelten unsere allgemeinen Lieferbedingungen. Sie finden diese auf unserer Internetseite: [www.nopa-instruments.com](http://www.nopa-instruments.com).

This is our Catalogue. It remains our exclusive property. Please find our "General Terms of Sale" on our corporate website: [www.nopa-instruments.com](http://www.nopa-instruments.com).

Esto es nuestro catálogo queda nuestra propiedad. Nuestras condiciones generales de venta se encuentran en nuestra página web: [www.nopa-instruments.com](http://www.nopa-instruments.com).

Voilà notre catalogue et il demeure notre propriété. Veuillez consulter nos conditions générales de vente sur notre page Internet: [www.nopa-instruments.com](http://www.nopa-instruments.com).

Questo è nostro catalogo e rimane nostra proprietà. Trovano applicazione le nostre condizioni generali di fornitura, che sono disponibili sul nostro sito: [www.nopa-instruments.com](http://www.nopa-instruments.com).

Modelländerungen vorbehalten. Nachdruck, auch auszugsweise, verboten.  
Change of design and pattern reserved. Re-printing, even in extracts, not permitted.  
Nos reservamos el derecho de modificaciones sin aviso previo. Reimpresión, también parcialmente, está prohibido.  
Tous droits réservés aux changements de modèle. Réimprimer, également partiellement, est interdit.  
Noi riserviamo il diritto di effettuare delle modificazioni. Ristampa di divieto anche parziale.

Anatomie des Auges  
 Anatomy of the eye  
 Anatomía del ojo  
 Anatomie des yeux  
 Anatomia dell' occhio

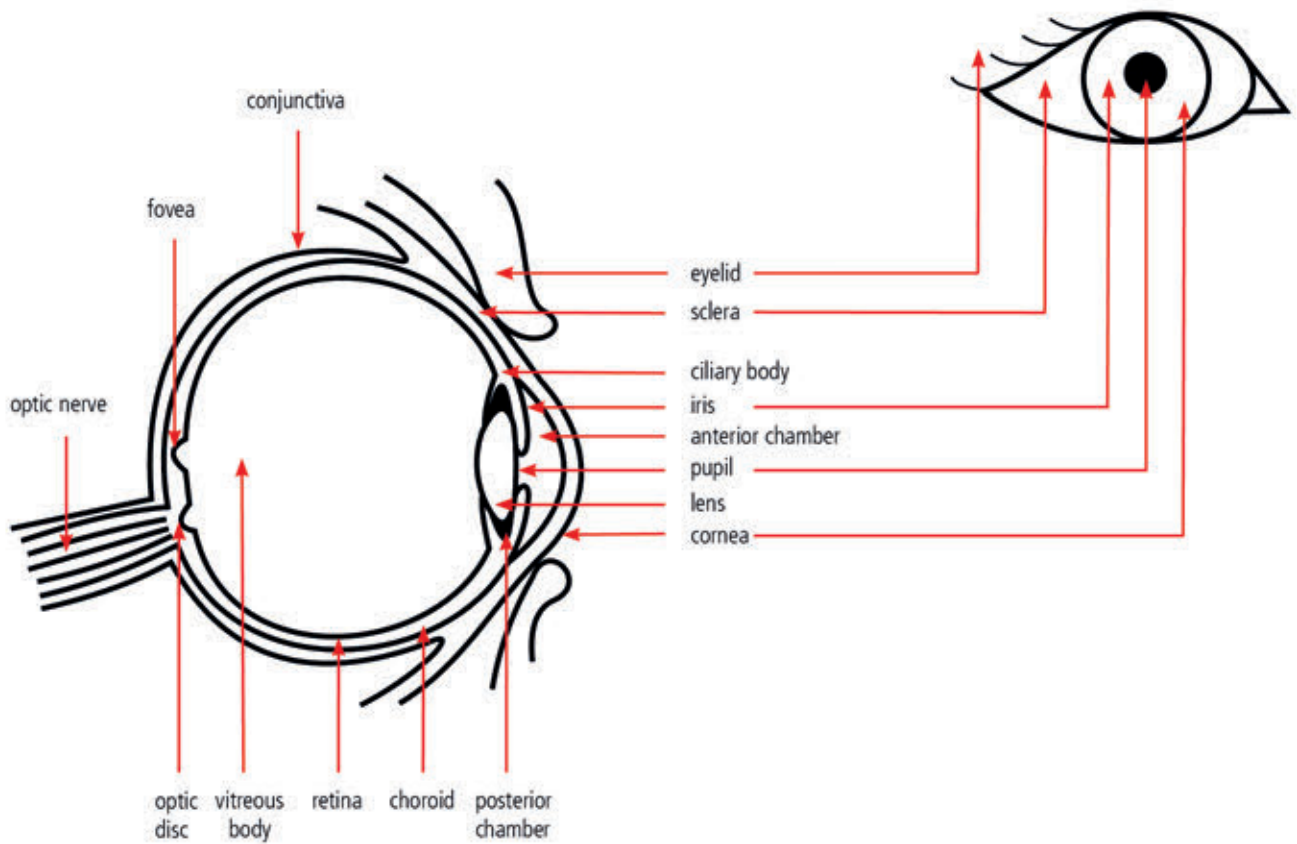

CATALOGUES

Bitte fordern Sie unsere  
entsprechenden Kataloge an.

Please request for our  
appropriate catalogues.

Por favor pidan por nuestros  
catálogos apropiados.

Veillez demander nos  
catalogues appropriés.

Vogliate richiedere i nostri  
cataloghi adatti.

**>> Unser Lieferprogramm**

Allgemeinchirurgie  
Gynäkologie, Geburtshilfe und Urologie  
Plastische Chirurgie und HNO  
Thorax, Herz und Gefäßchirurgie  
Neurochirurgie  
Ophthalmologie  
Endoskopie  
Container und Sterilisation  
Dental und Oral

**>> Our product range**

General Surgery  
Gynecology, obstetrics and urology  
Plastic Surgery and ENT  
Thoracic and cardiovascular surgery  
Neurosurgery  
Ophthalmology  
Endoscopy  
Container and Sterilization  
Dental and Oral

**>> Nuestra gama  
de productos**

Cirugía general  
Ginecología, obstetricia y urología  
Cirugía plástica y ORL  
Cirugía torácica y cardiovascular  
Neurocirugía  
Oftalmología  
Endoscopia  
Contenedor y esterilización  
Odontología y oral

**>> Notre gamme**

Chirurgie générale  
Gynécologie, obstétrique et urologie  
Chirurgie plastique et ORL  
Chirurgie thoracique et cardiovasculaire  
Neurochirurgie  
Ophtalmologie  
Endoscopie  
Conteneur et stérilisation  
Dental et Oral

**>> Nostro programma  
di produzione**

Chirurgia generale  
Ginecologia, ostetricia e urologia  
Chirurgia plastica ed ORL  
Chirurgia toracica e cardiovascolare  
Neurochirurgia  
Oftalmologia  
Endoscopia  
Contentitore e sterilizzazione  
Odontoiatria e Orale

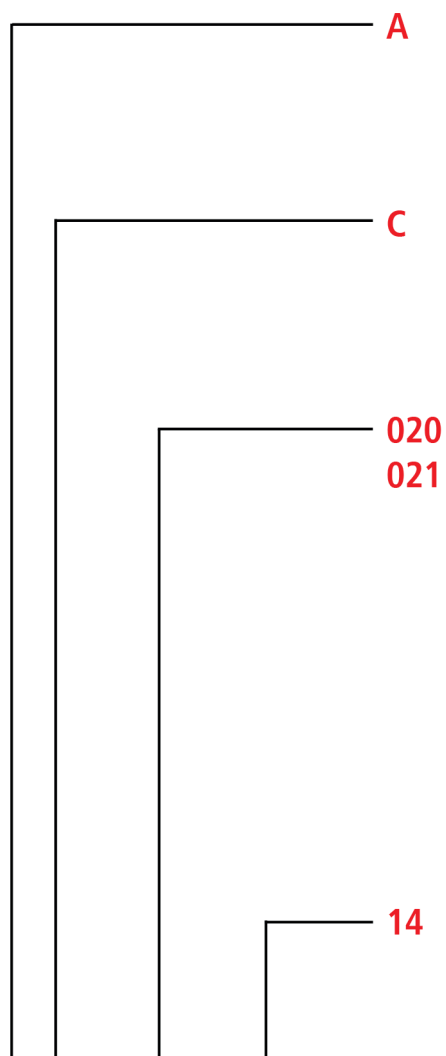

Artikelcode **AC 020/14**

#### Allgemeines Instrumentarium

General Instruments  
Instrumental Général  
Instruments Générales  
Strumenti generali

#### Scheren

Scissors  
Tijeras  
Ciseaux  
Forbici

#### Fortlaufende Nummern

Gerade Ziffer = gerades Instrument  
Ungerade Ziffer = gebogenes Instrument

#### Continuous number

Even number = straight instrument  
Odd number = curved instrument

#### Número de orden

números pares = instrumento derecho  
números impares = instrumento curvado

#### Numéros d'ordre

numéro pair = instrument droit  
numéro impair = instrument courbe

#### Numeri progressivi

numero pari = strumento retto  
numero dispari = strumento curvo

#### Länge oder Figur

Length or Figure  
Longitud o figura  
Longueur ou figure  
Lunghezza o figura

INDEX SETS

ZS 160/00	>> Notfall • Emergency • emergencia • urgence • emergenza	11-16
ZS 160/05	>> Fremdkörper • Foreign Body • cuerpo extraño • corps étranger • corpo estraneo	17
ZS 160/10	>> Nahtentfernung • Stitch Removal • retiro de suturas • enlèvement de suture • togliere la sutura	18
ZS 160/15	>> Strabismus / Muskel • Strabismus / Muscle • estrabismo / musculo • strabisme / muscle • strabismo / muscolo	19-22
ZS 160/20	>> Chalazion • Chalazion • chalazión • chalazion • calazio	23-24
ZS 160/25	>> Enukleation • Enucleation • enucleación • énucléation • enucleazione	25-28
ZS 160/30	>> Glaukom • Glaucoma • glaucoma • glaucome • glaucoma	29-32
ZS 160/35	>> Katarakt E.C. • Cataract E.C. • catarata E.C. • cataracte E.C. • cataratta E.C.	33-38
ZS 160/40	>> Katarakt Linse • Cataract Phacoemulsification • catarata facoemulsificación • cataracte phacoémulsification • cataratta facoemulsificazione	39-44
ZS 160/45	>> Keratoplastik • Keratoplasty • queratoplastia • kératoplastie • cheratoplastica	45-48
ZS 160/50	>> Keratomie astigmatisch • Astigmatic Keratotomy • queratoplastia astigmatismo • kératotomie astigmaté • cheratotomia astigmatica	49-50
ZS 160/55	>> Netzhautablösung • Retinal Detachment • desprendimiento de retina DR • décollement de la rétine • distacco della retina	51-56
ZS 160/60	>> Lid-Konjunktiva • Lid-Conjunctiva • conjunctiva • paupière-conjonctive • congiuntiva	57-60
ZS 160/65	>> Pterygium • Pterygium • pterigión • ptérygion • pterigio	61-62
ZS 160/70	>> Dacryocystorhinostomie • Dacryocystorhinostomy • dacriocistorinostomia • dacryocystorhinostomie • dacriocistorinostomia	63-66
ZS 160/75	>> Lasik • Lasik • lasik • lasik • lasik	67-68
ZS 160/80	>> Radiäre Keratotomie • Radiale Keratotomy • queratotomía radial • kératotomie radiale • cheratotomia radiale	69-70
ZS 160/85	>> Vitrektomie (Pars Plana) • Vitrectomy (Pars Plana) • vitrectomía pars-plana • vitrectomie (pars plana) • vitrectomia pars-plana	71-74

## INDEX INSTRUMENTS

>> Klemmen • Hemostats • Pinzas hemostáticas Pinces hémostatiques • Pinze emostatiche	75-80	AA
>> Pinzetten • Forceps • Pinzas • Pinces • Pinze	81-98	AB
>> Scheren • Scissors • Tijeras • Ciseaux • Forbici	99-118	AC
>> Skalpelle • Scalpels • Bisturíes • Bistouris • Bisturi	119-124	AD
>> Naht • Suture • Sutura • Suture • Sutura	125-134	AE
>> Diagnostik • Diagnostics • Diagnóstico • Diagnostic • Diagnostica	141-144	AR
>> Ophthalmologie • Ophthalmology • Oftalmología Ophtalmologie • Oftalmologia	145-206	KP
>> Endoskopie • Endoscopy • Endoscopia • Endoscopie • Endoscopia	207-210	XR

**KYE**

- >> Bitte fordern Sie unseren Spezialkatalog für Sterilisationscontainer an.
- >> Please request for our special catalogue for Sterilization Containers.
- >> Por favor pida por nuestro catálogo especial de contenedores de esterilización.
- >> Nous vous prions de demander notre catalogue spécial des conteneurs de stérilisation.
- >> Chieda prego il nostro catalogo per contenitori di sterilizzazione.





Contents:		Qty
AA 060/03	DIEFFENBACH BULLDOG CLAMPS STR 3,5 CM	2
AA 150/12	HALSTED-MOSQUITO FCPS STR 12,5 CM	2
AA 151/12	HALSTED-MOSQUITO FCPS CVD 12,5 CM	2
AA 711/09	JONES TOWEL FORCEPS 9,0 CM	2
AB 710/10	GRAEFE IRIS FORCEPS STR SERR. 10,0 CM	1
AB 734/01	BONN IRIS FORCEPS W.GUIDE PIN 1X2T. 7,0 CM	1
AB 738/08	BISHOP-HARMAN IRIS FORCEPS 1X2 T. 8,5 CM	1
AB 750/07	BARRAQUER-KATZIN FIX.FCPS 1X2 T. 7,0 CM	1
AB 796/02	LESTER FIXATION FORCEPS 1X2 TEETH 9,0 CM	1
AB 816/01	CASTROVIEJO SUTURE FORCEPS 0,12 MM 10,0 CM	2
AB 820/10	KELMAN-MCPHERSON TYING FORCEPS 10,0 CM	1
AB 828/10	PAUFIQUE SUTURE FORCEPS 1X2 TEETH 10,0 CM	1
AC 431/08	MOD.BONN SCISSORS CVD 8,0 CM	1
AC 466/10	IRIS SCISSORS STR W LARGE BOWS 10,0 CM	1
AC 475/11	STEVENS TENOTOM.SCS.CVD POINTED 11,5 CM	1
AC 768/05	BARRAQUER EYE SCISSORS 5,5 CM 5 MM	1
AC 782/11	WESTCOTT TENOTOMY SCISSORS BLUNT 11,0 CM	1
AC 797/01	WESTCOTT STRABISMUS SCS STR SHARP 11,5 CM	1
AD 540/00	RAZER BLADES, PACKING UNIT 10 PIECES	1
AD 550/09	BLADE BREAKER 9.0 CM DIA 5,5 MM	1
AE 600/10	BARRAQUER-TROUTMAN MICRO-NH STR RA 10,0 CM	1
AE 602/10	BARRAQUER-TROUTMAN MICRO-NH STR 10,0 CM	1
AE 660/14	CASTROVIEJO NH STR RA SMOOTH 14,0 CM	1
AK 090/10	DESMARRES RETRACTOR 10 MM 13,0 CM	1
AK 090/12	DESMARRES RETRACTOR 12 MM 13,0 CM	1
AK 090/14	DESMARRES RETRACTOR 14 MM 13,0 CM	1
AR 250/15	MEASURING INSTRUMENT 15,0 CM	1
AR 282/20	CASTROVIEJO CIRCLE 8,0 CM STRAIGHT	1
KP 002/12	JAMESON MUSCLE HOOK 12,0 CM	1
KP 010/14	GASS RETINAL DETACHMENT HOOK 14,0 CM	1
KP 015/02	GRAEFE STRABISMUS HOOK #2 14,0 CM	1
KP 018/12	STEVENS TENOTOMY HOOK 12,0 CM	1
KP 023/01	FIXATION HOOK RIGHT 11,0 CM	1
KP 150/05	BARRAQUER-COLIBRI EYE SPECULA 5,0 MM 3,0 CM	1
KP 150/10	BARRAQUER-COLIBRI EYE SPECULA 10,0 MM 3,0 CM	1
KP 154/04	BARRAQUER PHACO EYE SPECULA 4,0 CM	1
KP 212/08	LIEBERMAN EYE SPECULA 15,0 MM 8,0 CM	1
KP 280/14	SCHOCKET SCLERAL DEPRESSOR 14,0 CM	1
KP 542/01	SCHIOETZ TONOMETER STRAIGHT SCALE	1
KP 700/00	BISHOP-HARMON ANTERIOR CHAMBER	1
KP 731/27	SAUTTER AIR INJECTION CANNULA 27G 3,5 CM	1
SK 305/05	WIRE BASKET, 485 X 255 X 50 MM	1

Sterilization Container KYE 200/61, if required

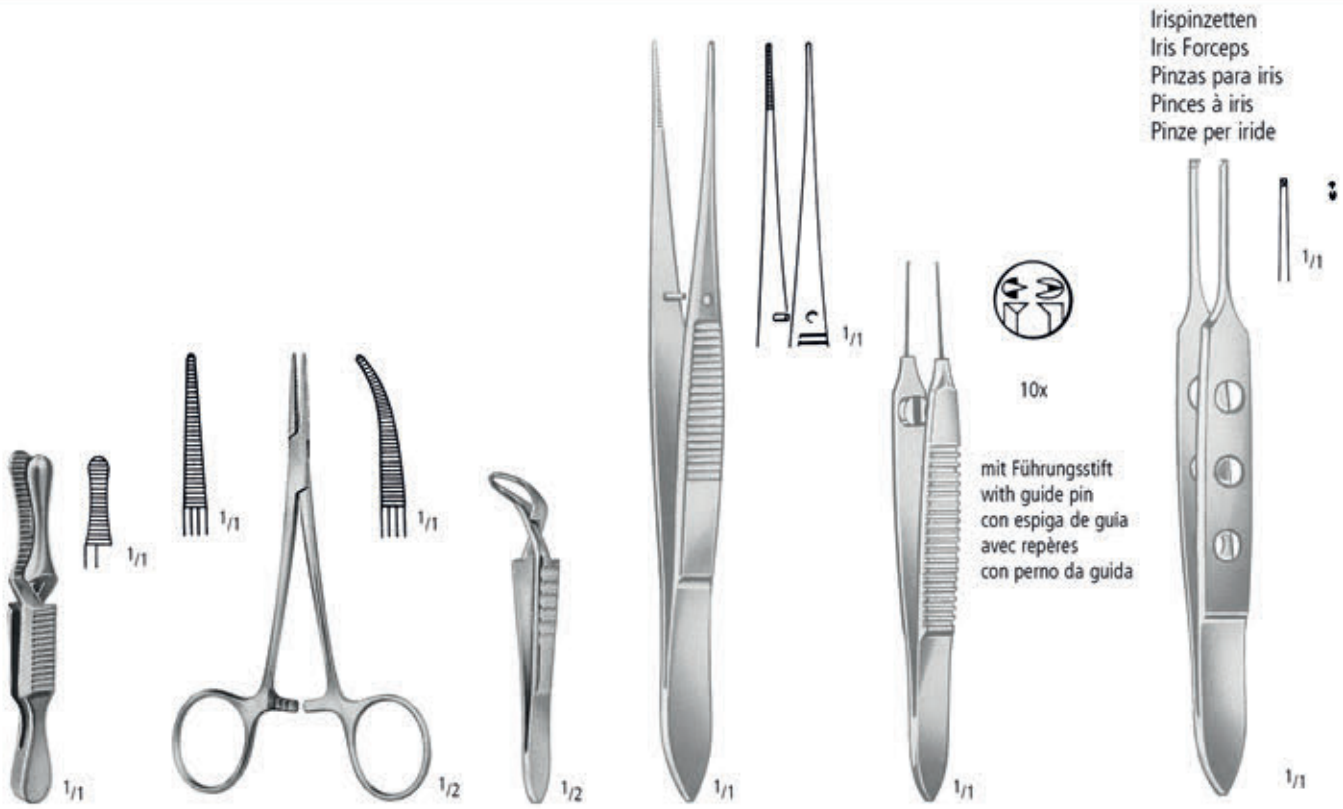

Irispinzetten  
Iris Forceps  
Pinzas para iris  
Pinces à iris  
Pinze per iride



10x

mit Führungsstift  
with guide pin  
con espiga de guía  
avec repères  
con perno da guida

**DIEFFENBACH**  
AA 060/03  
3,5 cm/1 1/2"

**HALSTED-MOSQUITO**  
AA 150/12 AA 151/12  
12,5 cm/5"

**JONES**  
AA 711/09  
9,0 cm/3 1/2"

**GRAEFE**  
AB 710/10  
10,0 cm/4"

**MOD. BONN 1:2**  
AB 734/01  
7,0 cm/2 3/4"

**BISHOP-HARMAN 1:2**  
AB 738/08  
8,5 cm/3 1/3"

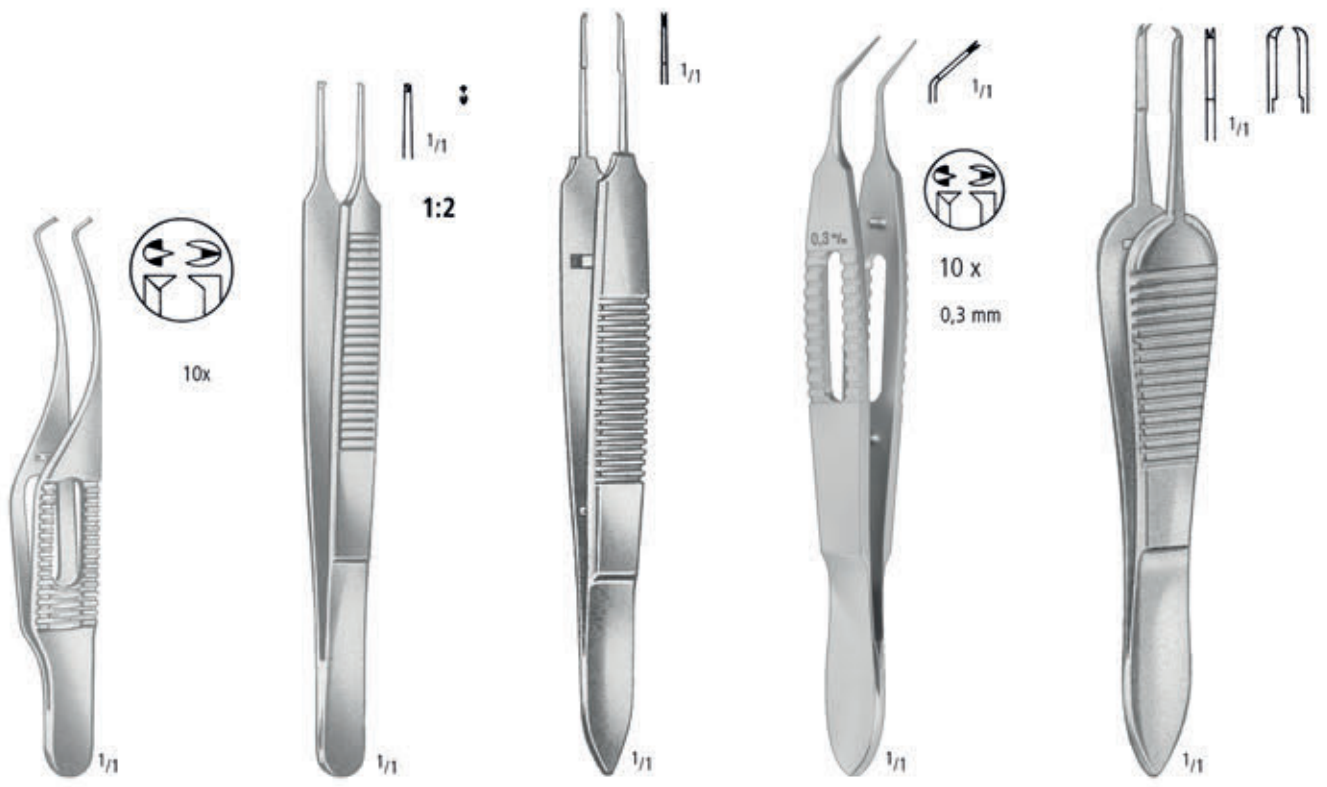

10 x

0,3 mm

**BARRAQUER-KATZIN 1:2**  
**(Colibri)**  
AB 750/07  
7,0 cm/2 3/4"

**LESTER**  
AB 796/02  
9,0 cm/3 1/2"

**CASTROVIEJO 1:2**  
AB 816/01  
0,12 mm  
10,0 cm/4"

**KELMAN-McPHERSON 1:2**  
AB 820/10  
10,0 cm/4"

**PAUFIGUE 1:2**  
AB 828/10  
10,0 cm/4"

mit großen Ringen  
with large bows  
con anillos grandes  
avec grands anneaux  
con anelli grandi

Sehnenscheren  
Tenotomy Scissors  
Tijeras para tenotomía  
Ciseaux à ténatomie  
Forbici per tenotomia

spitz  
pointed  
agudas  
pointues  
acuta

gebogen  
curved  
curvas  
courbes  
curve

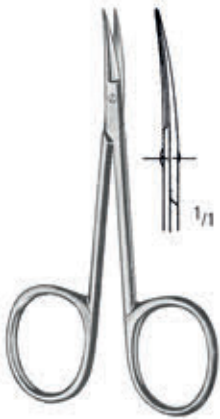

**MOD. BONN**  
AC 431/08  
8,0 cm/3"



AC 466/10  
10,0 cm/4"

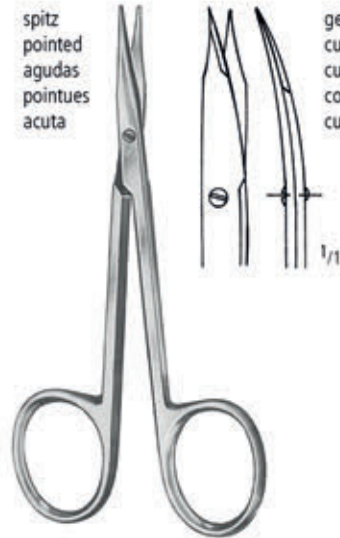

**STEVENS**  
AC 475/11  
11,5 cm/4 1/2"



**BARRAQUER**  
5,5 cm/2 1/4"  
5 mm AC 768/05

RASIERKLINGEN, VERPACKUNGSEINHEIT 10 STCK  
RAZOR BLADES, PACKING UNIT 10 PIECES  
HOJAS DE AFEITAR, UNIDAD DE VENTA 10 PZ  
LAMES DE RASOIR, UNITÉ À 10 PIÈCES  
LAMETTE DA BARBA, UNITÀ DI VENDITA 10 PZ



**WESTCOTT**  
AC 782/11  
11,0 cm/4 1/3"



**WESTCOTT**  
AC 797/01  
11,5 cm/4 1/2"



AD 540/00



**TROUTMAN-CHRIS**  
AD 550/09  
Ø 5,5 mm  
9,0 cm/3 1/2"



**BARRAQUER-TROUTMAN**  
AE 600/10  
10,0 cm/4"



**BARRAQUER-TROUTMAN**  
AE 602/10  
10,0 cm/4"



**CASTROVIEJO**  
AE 660/14  
14,0 cm/5 1/2"



AK 090/10  
10 mm

AK 090/12  
12 mm

AK 090/14  
14 mm

**DESMARRES**  
13,0 cm/5"



Messbereich 20 mm  
measuring range 20 mm  
campo de medición 20 mm  
étendue de mesurage 20 mm  
ampiezza di misura 20 mm

AR 250/15  
15,0 cm/6"



**CASTROVIEJO**  
AR 282/20  
8,0 cm/3"



**JAMESON**  
KP 002/12  
12,0 cm/4<sup>3</sup>/<sub>4</sub>"

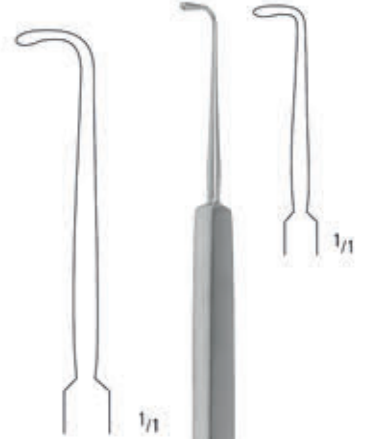

**GRAEFE**  
KP 015/02  
14,0 cm/5<sup>1</sup>/<sub>2</sub>"  
Fig. 2



**GASS**  
KP 010/14  
14,0 cm/5<sup>1</sup>/<sub>2</sub>"



**STEVENS**  
KP 018/12  
12,0 cm/4<sup>3</sup>/<sub>4</sub>"



rechts  
right  
derecha  
droit  
destra

KP 023/01  
11,0 cm/4<sup>1</sup>/<sub>2</sub>"

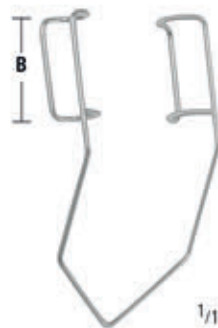

**BARRAQUER-COLIBRI**  
B

Fig. 1  
Frühgeborene  
Premature infant  
Parto prematuro  
Accouchement prématuré  
Parto prematuro

Fig. 2  
100 mm  
Child  
Niños  
Enfants  
Bambini

KP 150/05  
3,0 cm/1<sup>1</sup>/<sub>4</sub>"

KP 150/10  
3,0 cm/1<sup>1</sup>/<sub>4</sub>"



**BARRAQUER PHAKO**  
KP 154/04  
4,0 cm/1<sup>1</sup>/<sub>2</sub>"



**LIEBERMAN**  
KP 212/08  
8,0 cm/3<sup>1</sup>/<sub>4</sub>"  
B = 15 mm



**SCHOCKET**  
KP 280/14  
14,0 cm/5 1/2"



gerade Skala  
straight scale  
graduado recto  
échelle droite  
scala retta

**SCHIOETZ**  
KP 542/01  
13,0 cm/5"

Spezifikation Nr. 5, geeicht  
Specification No. 5, calibrated  
Especificación No. 5, calibrada  
Spécification No. 5, calibrée  
Specifica No. 5, calibrata

Set komplett  
Set complete  
Juego completo  
Jeu complet  
Set completo



**BISHOP-HARMON**  
KP 700/00

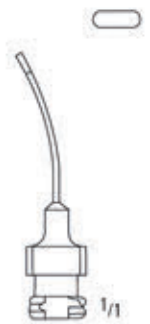

**SAUTER**  
KP 731/27  
3,5 cm/1 1/2"  
27G



L(mm)	B(mm)	H(mm)	
485	255	50	SK 305/05



Contents:

Qty

<b>KP 150/15</b>	BARRAQUER-COLIBRI EYE SPECULA 15 MM 4,0 CM	1
<b>KP 350/12</b>	FOREIGN BODY INSTRUMENT	1
<b>KP 415/10</b>	MEYHOEFER CHALAZION CURETTE	1
<b>SX 432/01</b>	SILICON MAT 275 X 125 MM	1

Sterilization container KYE 351/01, if required

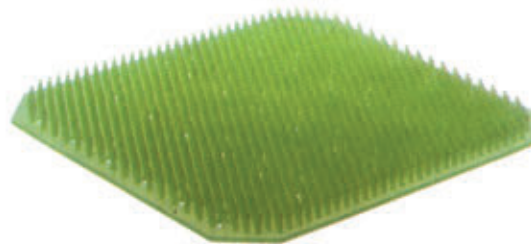
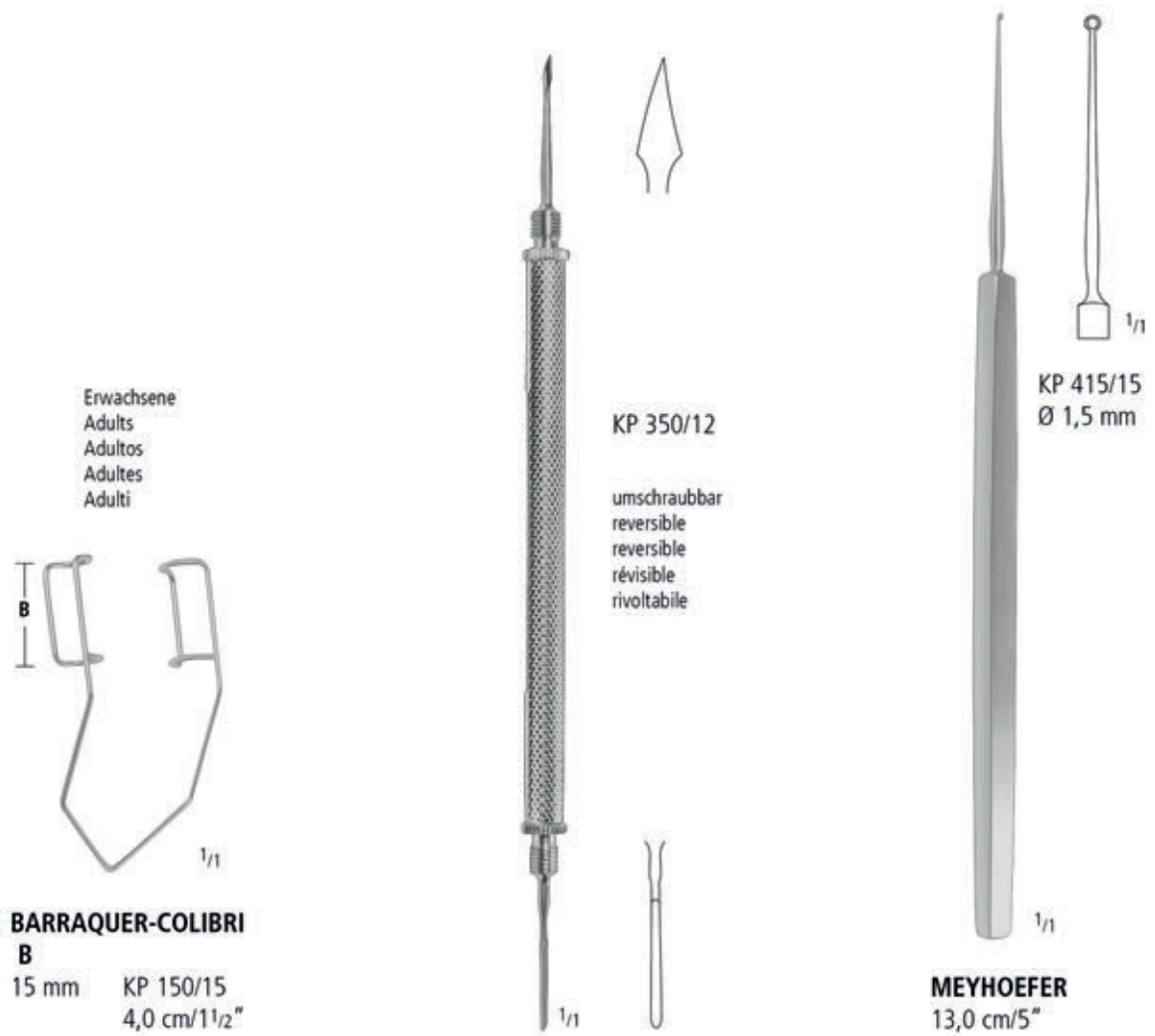

L(mm)	B(mm)	
275	125	SX 432/01

Contents:			Qty
<b>AB 750/07</b>	BARRAQUER-KATZIN FIX.FCPS 1X2 T. 7,0 CM		1
<b>AC 779/01</b>	GILLS-WELSH CAPSULOTOMY SCISSORS 8,5 CM		1
<b>KP 150/15</b>	BARRAQUER-COLIBRI EYE SPECULA 15 MM 4,0 CM		1
<b>SX 432/01</b>	SILICON MAT 275X125 MM		1

Sterilization container KYE 351/01, if required

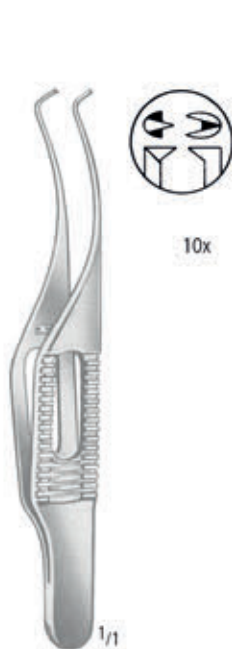

**BARRAQUER-KATZIN 1:2  
(Colibri)**  
AB 750/07  
7,0 cm/2<sup>3</sup>/<sub>4</sub>"



**GILLS-WELSH**  
AC 779/01  
8,5 cm/3<sup>1</sup>/<sub>3</sub>"



**BARRAQUER-COLIBRI**  
**B**  
15 mm KP 150/15  
4,0 cm/1<sup>1</sup>/<sub>2</sub>"

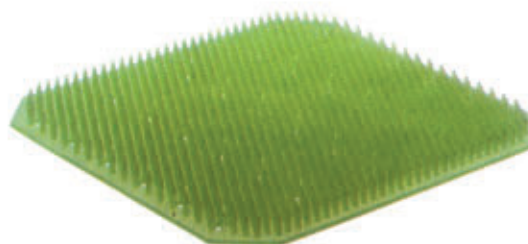

L(mm)	B(mm)	
275	125	SX 432/01



Contents:		Qty
<b>AA 060/03</b>	DIEFFENBACH BULLDOG CLAMPS STR 3,5 CM	1
<b>AA 114/10</b>	HARTMANN FORCEPS STR 10,0 CM	1
<b>AA 751/13</b>	BACKHAUS TOWEL FORCEPS 13,0 CM	1
<b>AB 734/01</b>	BONN IRIS FORCEPS W.GUIDE PIN 1X2T. 7,0 CM	1
<b>AB 816/01</b>	CASTROVIEJO SUTURE FORCEPS 10,0 CM	2
<b>AB 828/10</b>	PAUFIQUE SUTURE FORCEPS 1X2 TEETH 10,0 CM	1
<b>AB 835/09</b>	BERENS MUSCLE CLAMP 8,5 CM 5 TEETH WITH 1	
<b>AC 450/10</b>	IRIS SCISSORS STR SH/SH 10,5 CM	1
<b>AC 475/11</b>	STEVENS TENOTOM.SCS.CVD POINTED 11,5 CM	1
<b>AC 780/11</b>	WESTCOTT TENOTOMY SCS. POINTED 11,0 CM	1
<b>AC 797/01</b>	WESTCOTT STRABISMUS SCS STR SHARP 11,5 CM	1
<b>AE 660/14</b>	CASTROVIEJO NH STR RA SMOOTH 14,0 CM	1
<b>AE 661/14</b>	CASTROVIEJO NH CVD RA SMOOTH 14,0 CM	1
<b>AR 282/20</b>	CASTROVIEJO CIRCLE 8,0 CM STRAIGHT	1
<b>KP 001/13</b>	GREEN STRABISMUS HOOK 13,0 CM	1
<b>KP 010/14</b>	GASS RETINAL DETACHMENT HOOK 14,0 CM	1
<b>KP 015/01</b>	GRAEFE STRABISMUS HOOK #1 13,0 CM	1
<b>KP 015/02</b>	GRAEFE STRABISMUS HOOK #2 14,0 CM	1
<b>KP 015/03</b>	GRAEFE STRABISMUS HOOK #3 15,0 CM	1
<b>KP 018/12</b>	STEVENS TENOTOMY HOOK 12,0 CM	1
<b>KP 175/09</b>	CASTROVIEJO EYE SPECULA 16,0 MM 9,0 CM	1
<b>KP 262/13</b>	ARRUGA PROTECTOR 13,0 CM	1
<b>KP 540/13</b>	GONNIN AMSLER MARKER 11-23 MM / 1 MM	1
<b>KP 700/00</b>	BISHOP-HARMON ANTERIOR CHAMBER	1
<b>SK 105/05</b>	WIRE BASKET, 255 X 245 X 50 MM	1

Sterilization Container KYE 200/11, if required

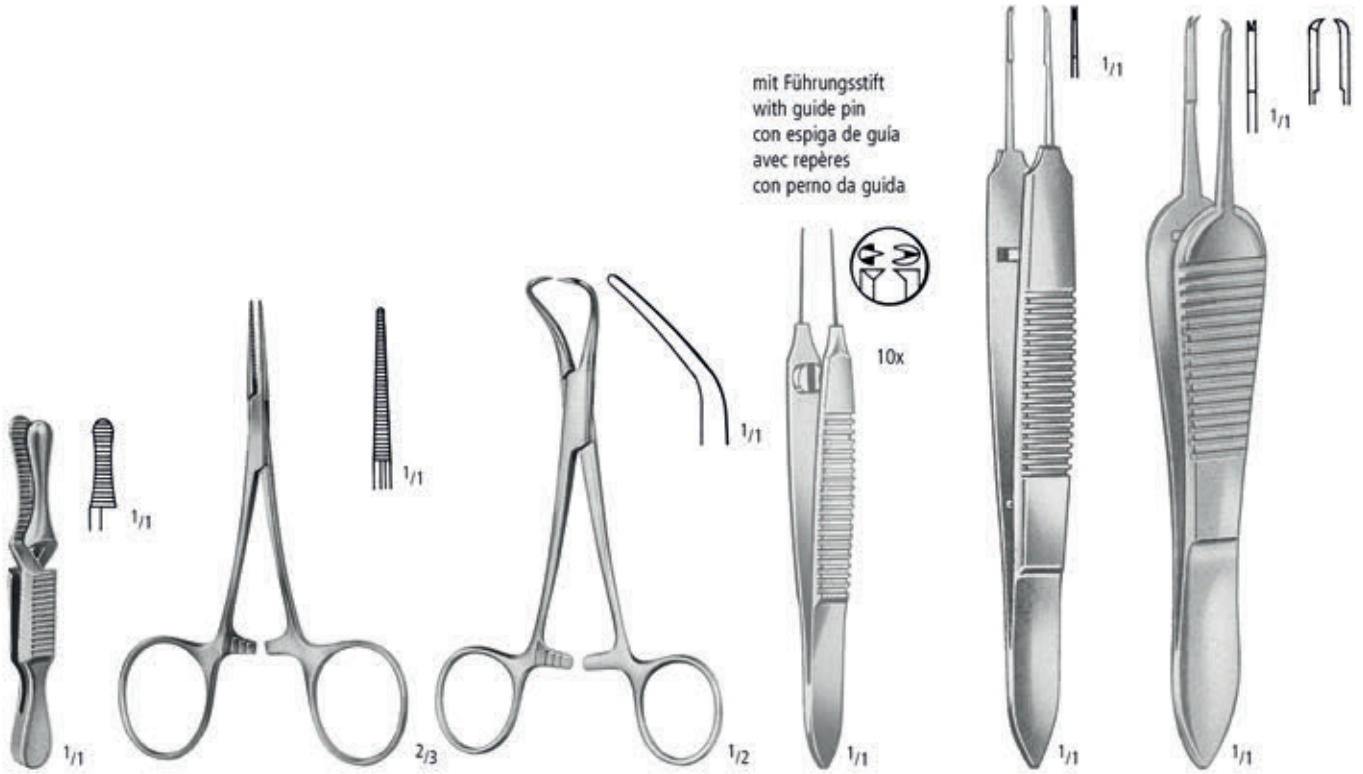

mit Führungsstift  
with guide pin  
con espiga de guía  
avec repères  
con perno da guida



10x

**DIEFFENBACH**  
AA 060/03  
3,5 cm/1 1/2"

**HARTMANN**  
AA 114/10  
10,0 cm/4"

**BACKHAUS**  
AA 751/13  
13,0 cm/5"

**MOD. BONN 1:2**  
AB 734/01  
7,0 cm/2 3/4"

**CASTROVIEJO 1:2**  
AB 816/01  
0,12 mm  
10,0 cm/4"

**PAUFIQUE 1:2**  
AB 828/10  
10,0 cm/4"

Irisscheren  
Iris Scissors  
Tijeras para iridectomía  
Ciseaux à iridectomie  
Forbici per iridectomia

Sehnenscheren  
Tenotomy Scissors  
Tijeras para tenotomía  
Ciseaux à ténotomie  
Forbici per tenotomia

spitz  
pointed  
agudas  
pointues  
acuta

gebogen  
curved  
curvas  
courbes  
curve

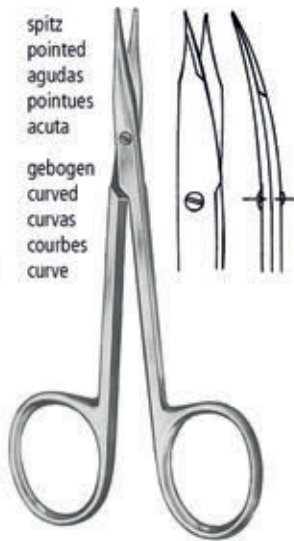

**BERENS**  
AB 835/09  
8,5 cm/3 1/3"

**AC 450/10**  
10,5 cm/4 1/4"

**STEVENS**  
AC 475/11  
11,5 cm/4 1/2"

**WESTCOTT**  
AC 780/11  
11,0 cm/4 1/3"

**WESTCOTT**  
AC 797/01  
11,5 cm/4 1/2"

**CASTROVIEJO**  
14,0 cm/5 1/2"

Messbereich 20 mm  
measuring range 20 mm  
campo de medición 20 mm  
étendue de mesurage 20 mm  
ampiezza di misura 20 mm



**CASTROVIEJO**  
AR 282/20  
8,0 cm/ 3"



**GREEN**  
KP 001/13  
13,0 cm/5"



**GASS**  
KP 010/14  
14,0 cm/5 1/2"



**GRAEFE**  
KP 015/01  
13,0 cm/5"  
Fig. 1



**GRAEFE**  
KP 015/02  
14,0 cm/5 1/2"  
Fig. 2



**GRAEFE**  
KP 015/03  
15,0 cm/6"  
Fig. 3



**STEVENS**  
KP 018/12  
12,0 cm/4 3/4"



**CASTROVIEJO**  
KP 175/09  
9,0 cm/3 1/2"  
B = 16 mm



1/1

**ARRUGA**  
KP 262/13  
13,0 cm/5"



1/1

**GONNIN**  
KP 540/13  
13,0 cm/5"  
11-23 mm / 1 mm



1/2

**BISHOP-HARMON**  
KP 700/00

Set komplett  
Set complete  
Juego completo  
Jeu complet  
Set completo



L(mm)	B(mm)	H(mm)	
255	245	50	SK 105/05

**ZS 160/20** CHALAZION CHALAZION CHALAZIÓN CHALAZION CALAZIO

Contents:		Qty
<b>AB 828/10</b>	PAUFIQUE SUTURE FORCEPS 1X2 TEETH 10,0 CM	1
<b>AB 840/01</b>	DESMARRES CHALAZION FORCEPS FIG.1 9,0 CM	1
<b>AB 840/02</b>	DESMARRES CHALAZION FORCEPS FIG.2 9,0 CM	1
<b>AC 467/10</b>	IRIS SCISSORS CVD W LARGE BOWS 10,0 CM	1
<b>AE 661/14</b>	CASTROVIEJO NH CVD RA SMOOTH 14,0 CM	1
<b>KP 248/11</b>	JAEGER LID PLATE 11,0 CM	1
<b>KP 415/10</b>	MEYHOEFER CHALAZION CURETTE 13,0 CM	1
<b>KP 415/20</b>	MEYHOEFER CHALAZIONCURETTE 13,0 CM 2,0 MM	1
<b>KP 415/25</b>	MEYHOEFER CHALAZIONCURETTE 13,0 CM 2,5 MM	1
<b>SK 105/05</b>	WIRE BASKET, 255 X 245 X 50 MM	1

Sterilization Container KYE 200/11, if required



**MOD. TÜBINGEN**  
AB 826/10  
10,0 cm/4"



**DESMARRES**  
9,0 cm/3 1/2"

mit großen Ringen  
with large bows  
con anillos grandes  
avec grands anneaux  
con anelli grandi

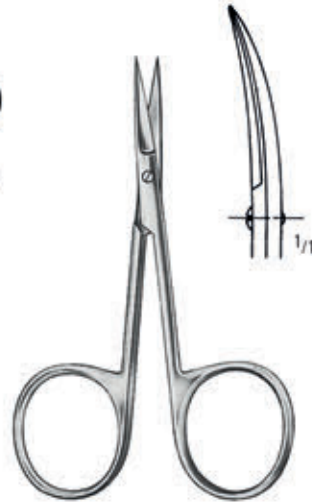

AC 467/10  
10,0 cm/4"



**CASTROVIEJO**  
AE 661/14  
14,0 cm/5 1/2"



**JAEGER**  
KP 248/11  
11,0 cm/4 1/2"



**MEYHOEFER**  
13,0 cm/5"

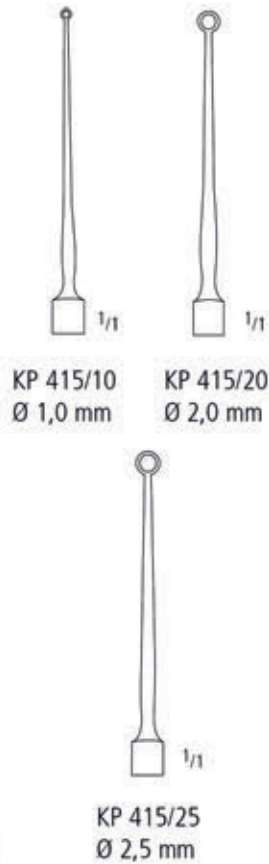

L(mm)	B(mm)	H(mm)	
255	245	50	SK 105/05

Contents:		Qty
<b>AA 150/14</b>	HALSTED-MOSQUITO ART.FCPS STR 14,0 CM	2
<b>AA 151/14</b>	HALSTED-MOSQUITO ART.FCPS CVD 14,0 CM	2
<b>AA 751/08</b>	BACKHAUS TOWEL FORCEPS 8,0 CM	2
<b>AB 785/01</b>	GRAEFE FIX.FCPS W/O SPRING CATCH 11,0 CM	1
<b>AB 828/10</b>	PAUFIQUE SUTURE FORCEPS 1X2 TEETH 10,0 CM	1
<b>AB 832/01</b>	BLASCOVICS MUSCULAR FORCEPS FIG.1 9,0 CM	1
<b>AC 461/11</b>	STRABISMUS SCISSORS CVD BLUNT 11,5 CM	1
<b>AC 467/10</b>	IRIS SCISSORS CVD W LARGE BOWS 10,0 CM	1
<b>AC 475/11</b>	STEVENS TENOTOM.SCS.CVD POINTED 11,5 CM	1
<b>AE 661/14</b>	CASTROVIEJO NH CVD RA SMOOTH 14,0 CM	1
<b>KP 015/03</b>	GRAEFE STRABISMUS HOOK FIG. 3 15,0 CM	1
<b>KP 200/15</b>	COOK EYE SPECULA 15 MM 5,0 CM	1
<b>KP 400/01</b>	BUNGE EXENTERATION SPOON 14,0 CM 7,0 MM	1
<b>KP 405/15</b>	WELLS ENUCLEATION SPOON LARGE 15,0 CM	1
<b>SK 105/05</b>	WIRE BASKET, 255 X 245 X 50 MM	1

Sterilization Container KYE 200/11, if required



ohne Schloss  
without spring catch  
sin cierre de resorte  
sans arrêt à ressort  
senza arresto a molla

**HALSTED-MOSQUITO**  
AA 150/14 AA 151/14  
14,0 cm/5 1/2"

**BACKHAUS**  
AA 751/08  
8,0 cm/3"

**GRAEFE**  
AB 785/01  
11,0 cm/4 1/3"

**PAUFIQUE 1:2**  
AB 828/10  
10,0 cm/4"

**BLASCOVICS**  
AB 832/01  
9,0 cm/3 1/2"

Strabismusscheren  
Strabismus Scissors  
Tijeras para estrabismos  
Ciseaux à strabisme  
Forbici per strabismo

mit großen Ringen  
with large bows  
con anillos grandes  
avec grands anneaux  
con anelli grandi

Sehnenscheren  
Tenotomy Scissors  
Tijeras para tenotomía  
Ciseaux à ténatomie  
Forbici per tenotomia



AC 460/11  
11,5 cm/4 1/2"

AC 467/10  
10,0 cm/4"

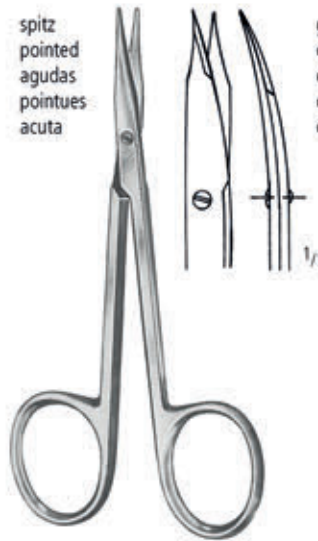

spitz  
pointed  
agudas  
pointues  
acuta

gebogen  
curved  
curvas  
courbes  
curve

**STEVENS**  
AC 475/11  
11,5 cm/4 1/2"

**CASTROVIEJO**  
AE 661/14  
14,0 cm/5 1/2"



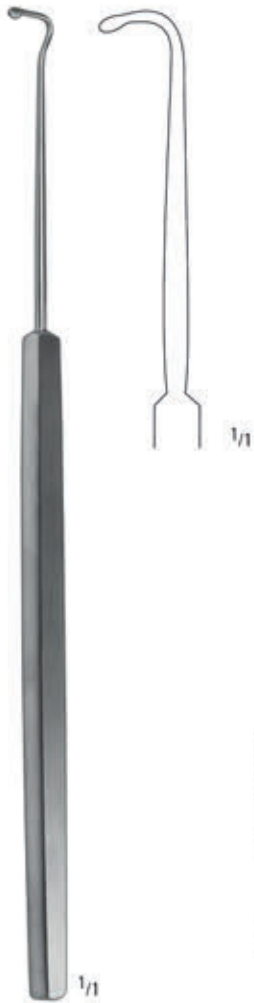

**GRAEFE**  
 KP 015/03  
 15,0 cm/6"  
 Fig. 3



**COOK**  
 B  
 15 mm  
 KP 200/15  
 5,0 cm/ 2"



**BUNGE**  
 KP 400/01  
 14,0 cm/5 1/2"

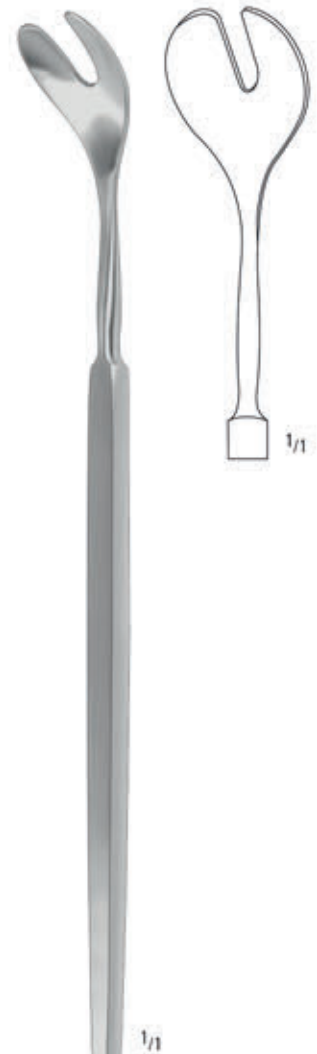

**WELLS**  
 KP 405/15  
 15,0 cm/6"



L(mm)	B(mm)	H(mm)	
255	245	50	SK 105/05



Contents:		Qty
AA 114/10	HARTMANN FORCEPS STR 10,0 CM	1
AA 751/08	BACKHAUS TOWEL FORCEPS 8,0 CM	2
AB 710/10	GRAEFE IRIS FORCEPS STR SERR. 10,0 CM	1
AB 714/10	GRAEFE IRIS FORCEPS STR 1X2 TEETH 10,0 CM	1
AB 734/01	BONN IRIS FORCEPS W.GUIDE PIN 1X2T. 7,0 CM	1
AB 750/07	BARRAQUER-KATZIN FIX.FCPS 1X2 T. 7,0 CM	1
AB 792/11	ELSCHNIG FIXATION FORCPES 1X2 TEETH 11,0 CM	1
AB 825/02	BONN SUTURE FORCEPS 10,0 CM ULRTA FINE	2
AC 431/08	MOD.BONN SCISSORS CVD 8,0 CM	1
AC 768/05	BARRAQUER EYE SCISSORS 5,50 CM 5,0 MM	1
AC 776/02	VANNAS MOD.TÜBINGEN CURVED 8,5 CM	1
AC 782/11	WESTCOTT TENOTOMY SCISSORS BLUNT 11,0 CM	1
AE 605/11	BARRAQUER MICRO-NEEDLE HOLDER CVD 10,0 CM	1
AE 660/14	CASTROVIEJO NH STR RA SMOOTH 14,0 CM	1
AR 282/20	CASTROVIEJO CIRCLE 8,0 CM STRAIGHT	1
KP 130/01	HARMS TRABECULAR PROBE RIGHT 4,5 CM	1
KP 130/02	HARMS TRABECULAR PROBE LEFT 4,5 CM	1
KP 161/05	CORCELLE EYE SPECULA 8 MM, 5,0 CM	1
KP 373/01	PREMIUM DIAMOND KNIFE ANGLED SPEER 1,4 CM	1
KP 376/01	PREMIUM DIAMOND KNIFE 1,0 CM 45° 7 STEPS	1
KP 478/12	MOD.DORTMUND PHACO SPATULA 12,0 CM	1
KP 543/01	SCHIOETZ TONOMETER INCLINED SCALE	1
KP 611/00	ELLIOT TREPHINE HANDLE ONLY 3,0 CM	1
KP 612/10	ELLIOT SCLERAL TREPHINE Ø 1,0 MM	1
KP 700/00	BISHOP-HARMON ANTERIOR CHAMBER	1
KP 712/27	MCINTYRE ANTERIOR CHAMBER CANNULA 27G	2
KP 731/27	SAUTTER AIR INJECTION CANNULA 27G 3,5 CM	2
SK 305/05	WIRE BASKET, 485 X 255 X 50 MM	1

Sterilization Container KYE 200/61, if required



**HARTMANN**  
AA 114/10  
10,0 cm/4"

**BACKHAUS**  
AA 751/08  
8,0 cm/3"

**GRAEFE**  
10,0 cm/4"

**MOD. BONN 1:2**  
AB 734/01  
7,0 cm/2<sup>3</sup>/<sub>4</sub>"



**BARRAQUER-KATZIN 1:2 (Colibri)**  
AB 750/07  
7,0 cm/2<sup>3</sup>/<sub>4</sub>"

**ELSCHNIG 1:2**  
AB 792/11  
11,0 cm/4<sup>1</sup>/<sub>3</sub>"

**MOD. BONN**  
AB 825/02  
10,0 cm/4"

**MOD. BONN**  
AC 431/08  
8,0 cm/3"

**BARRAQUER**  
5 mm AC 768/05  
5,5 cm/2<sup>1</sup>/<sub>4</sub>"

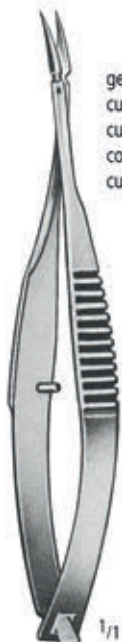

gebogen  
curved  
curvas  
courbes  
curve

1/1

**VANNAS MOD. TÜBINGEN**  
AC 776/02  
8,5 cm/3 1/3"



1/1

1/1

**WESTCOTT**  
AC 782/11  
11,0 cm/4 1/3"



1/1

1/2

**BARRAQUER**  
AE 605/13  
13,0 cm/5"



1/1

2/3

**CASTROVIEJO**  
AE 660/14  
14,0 cm/5 1/2"



1/1

**CASTROVIEJO**  
AR 282/15  
8,0 cm/ 3"

Messbereich 15 mm  
measuring range 15 mm  
campo de medición 15 mm  
étendue de mesurage 15 mm  
ampiezza di misura 15 mm



**HARMS**  
4,5 cm/1 3/4"

KP 130/01    KP 130/02

rechts  
right

links  
left

derecha  
droit  
destra

izquierda  
gauche  
sinistra

1/1

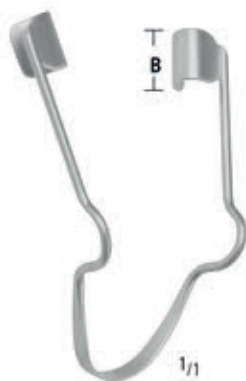

B

8

1/1

**CORCELLE**  
KP 161/05  
5,0 cm/ 2"  
B = 8 mm



1/1

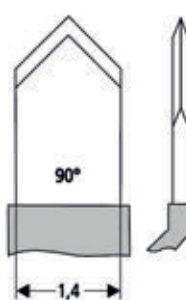

KP 373/01

7 Stufen:  
7 steps:  
7 escalones:  
7 étages:  
7 gradi:  
0 / 0,3 / 0,4 / 0,5 / 0,6 / 0,8 / 1,0 / 2,5 mm

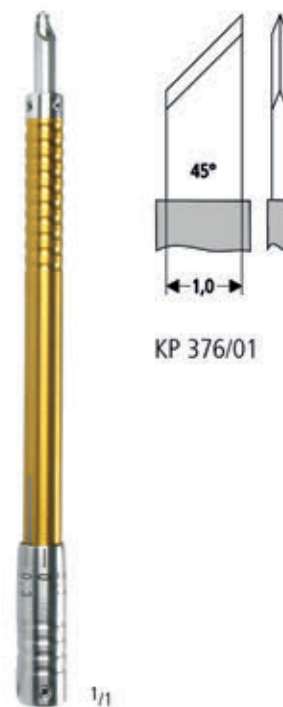

1/1

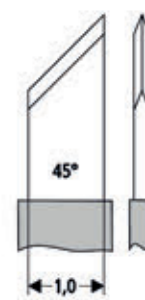

KP 376/01



**MOD. DORTMUND**  
 KP 478/12  
 12,0 cm/ 4<sup>3</sup>/<sub>4</sub>"  
 0,6 x 12 mm



schräge Skala  
 inclined scale  
 graduado inclinado  
 échelle oblique  
 scala inclinata

**SCHIOETZ**  
 KP 543/01  
 13,0 cm/5"

Spezifikation Nr. 5, geeicht  
 Specification No. 5, calibrated  
 Especificación No. 5, calibrada  
 Spécification No. 5, calibrée  
 Specifica No. 5, calibrata



**ELLIOT**  
 KP 611/00  
 3,0 cm/1<sup>1</sup>/<sub>4</sub>"



**ELLIOT**  
 KP 612/10  
 Ø 1,0 mm



Set komplett  
 Set complete  
 Juego completo  
 Jeu complet  
 Set completo

**BISHOP-HARMON**  
 KP 700/00



**McINTYRE**  
 2,5 cm/1"  
 KP 712/27  
 27G



**SAUTER**  
 KP 731/27  
 3,5 cm/1<sup>1</sup>/<sub>2</sub>"  
 27G



L(mm)	B(mm)	H(mm)	
485	255	50	SK 305/05

Contents:		Qty
AA 060/05	DIEFFENBACH BULLDOG CLAMPS STR 5,0 CM	2
AA 114/10	HARTMANN FORCEPS STR 10,0 CM	1
AA 751/08	BACKHAUS TOWEL FORCEPS 8,0 CM	2
AB 714/10	GRAEFE IRIS FORCEPS STR 1X2 TEETH 10,0 CM	1
AB 735/02	BONN MICRO IRIS FORCEPS ANGLED 7,0 CM	1
AB 750/07	BARRAQUER-KATZIN FIX.FCPS 1X2 T. 7,0 CM	1
AB 768/01	ARRUGA CAPSULAR FCPS NOT CALIBR. 10,0 CM	1
AB 792/11	ELSCHNIG FIXATION FORCPES 1X2 TEETH 11,0 CM	1
AB 819/02	MCPHERSON TYING FORCEPS ANGLED 10,5 CM	1
AB 825/02	BONN SUTURE FORCEPS 10,0 CM ULRTA FINE	1
AB 848/11	FAULKNER LENS HOLDING FORCEPS 11,0 CM	1
AC 431/08	MOD.BONN SCISSORS CVD 8,0 CM	1
AC 768/10	BARRAQUER EYE SCISSORS 5,5 CM 10 MM	1
AC 776/03	VANNAS MOD.TÜBINGEN ANGLED 8,5 CM	1
AC 778/02	VANNAS SEC.CATARACT SCISSORS,CVD. 8,0 CM	1
AC 782/11	WESTCOTT TENOTOMY SCISSORS BLUNT 11,0 CM	1
AC 785/01	CASTROVIEJO DELICATE EYE SCS. 10,0 CM RI.	1
AC 785/02	CASTROVIEJO DELICATE EYE SCS. 10,0 CM LE.	1
AC 797/02	WESTCOTT STRABISMUS SCS CVD SHARP 11,5 CM	1
AD 075/11	PCK=100 BLADES FIG.11	1
AD 554/13	BLADE BREAKER 13.0 CM DIA 8,0 MM	1
AE 603/10	BARRAQUER-TROUTMAN MICRO-NH CVD 10,0 CM	1
AE 660/14	CASTROVIEJO NH STR RA SMOOTH 14,0 CM	1
AE 688/14	KALT MICRO-NEEDLE HOLDER STR 14,0 CM	1
AR 282/20	CASTROVIEJO CIRCLE 8,0 CM STRAIGHT	1
KP 030/13	HIRSCHMANN IRIS HOOK 12,5 CM 45°	1
KP 071/25	SINSKEY LENS MANIPULATOR 12,0 CM	1
KP 154/04	BARRAQUER PHACO EYE SPECULA 4,0 CM	1
KP 440/13	SNELLEN LENS SCOOP SERRATED 13,0 CM	1
KP 478/12	MOD.DORTMUND PHACO SPATULA 12,0 CM	1
KP 545/02	MALONEY KERATOMETER INTRAOPERATIVE 2,0 CM	1
KP 700/00	BISHOP-HARMON ANTERIOR CHAMBER	1
KP 712/27	MCINTYRE ANTERIOR CHAMBER CANNULA 27G	1
KP 720/23	SIMCOE IRRIGATION AND ASPIRATION CANNULA	1
KP 731/27	SAUTTER AIR INJECTION CANNULA 27G 3,5 C	2
KP 755/23	KNOLLE-PEARCE LENS LOOP WITH IRRIGATION	1
KP 767/27	JENSEN CAPSULE POLISHER 27G DIAMOND	1
SK 305/05	WIRE BASKET, 485 X 255 X 50 MM	1

Sterilization Container KYE 200/61, if required



**DIEFFENBACH**  
AA 060/05  
5,0 cm/2"



**HARTMANN**  
AA 114/10  
10,0 cm/4"



**BACKHAUS**  
AA 751/08  
8,0 cm/3"

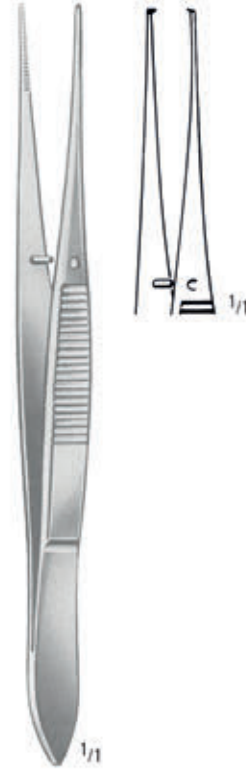

**GRAEFE**  
AB 714/10  
10,0 cm/4"



**MOD. BONN**  
AB 735/02  
7,0 cm/2<sup>3</sup>/<sub>4</sub>"



**BARRAQUER-KATZIN 1:2 (Colibri)**  
AB 750/07  
7,0 cm/2<sup>3</sup>/<sub>4</sub>"



ungeeicht  
not calibrated  
non calibrada  
non calibrée  
non calibrata

**ARRUGA**  
AB 768/01  
10,0 cm/4"



**ELSCHNIG 1:2**  
AB 792/11  
11,0 cm/4<sup>1</sup>/<sub>3</sub>"



**McPHERSON**  
AB 819/02  
10,0 cm/4"



**MOD. BONN**  
AB 825/02  
10,0 cm/4"



**FAULKNER**  
AB 848/11  
11,0 cm/4<sup>1</sup>/<sub>3</sub>"



sehr fein  
extra delicate  
muy finas  
très fin  
molto sottile

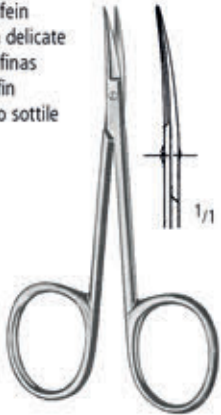

**MOD. BONN**  
AC 431/08  
8,0 cm/3"



**BARRAQUER**  
5,5 cm/2<sup>1</sup>/<sub>4</sub>"  
10 mm AC 768/10



kniegebogen  
angular  
acodadas  
coudés  
angolato

**VANNAS MOD. TÜBINGEN**  
AC 776/03  
8,5 cm/3<sup>1</sup>/<sub>3</sub>"

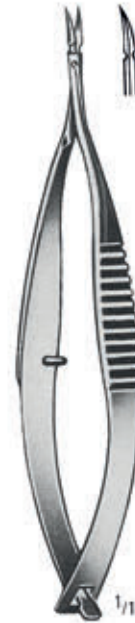

gebogen  
curved  
curvas  
courbes  
curve

**VANNAS**  
AC 778/02  
8,0 cm/3"



**WESTCOTT**  
AC 782/11  
11,0 cm/4<sup>1</sup>/<sub>3</sub>"



**CASTROVIEJO**  
AC 785/01  
10,0 cm/4"



**CASTROVIEJO**  
AC 785/02  
10,0 cm/4"

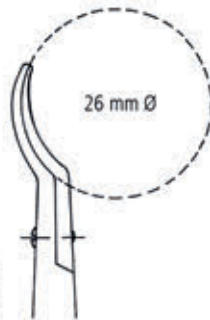

**WESTCOTT**  
AC 797/02  
11,5 cm/4<sup>1</sup>/<sub>2</sub>"



Fig. 11  
AD 075/11

steril  
sterile  
estériles  
stériles  
sterili



**CASTROVIEJO**  
AD 554/13  
Ø 8 mm  
13,0 cm/5"



**BARRAQUER-TROUTMAN**  
AE 603/10  
10,0 cm/4"



**CASTROVIEJO**  
AE 660/14  
14,0 cm/5 1/2"



**KALT**  
AE 688/14  
14,0 cm/5 1/2"



**CASTROVIEJO**  
AR 282/20  
8,0 cm/ 3"

Messbereich 20 mm  
measuring range 20 mm  
campo de medición 20 mm  
étendue de mesurage 20 mm  
ampiezza di misura 20 mm



**HIRSCHMANN**  
KP 030/13  
12,5 cm/5"



**SINSKEY**  
KP 071/25  
Ø 0,25 mm  
12,0 cm/4 3/4"

**TITANIUM**



**BARRAQUER PHAKO**  
KP 154/04  
4,0 cm/1 1/2"



**SNELLEN**  
KP 440/13  
13,0 cm/5"



**MOD. DORTMUND**  
KP 478/12  
12,0 cm/ 4 3/4"  
0,6 x 12 mm



**MALONEY**  
KP 545/02  
2,0 cm/3/4"



Set komplett  
Set complete  
Juego completo  
Jeu complet  
Set completo

**BISHOP-HARMON**  
KP 700/00

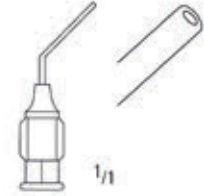

**McINTYRE**  
2,5 cm/1"  
KP 712/27  
27G



**SIMCOE**  
KP 720/23  
3,0 cm/1 1/4"  
25/23G

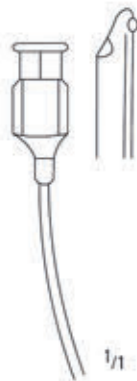

**SAUTTER**  
KP 731/27  
3,5 cm/1 1/2"  
27G



**KNOLLE-PEARCE**  
KP 755/23  
5,0 cm/2"  
23G

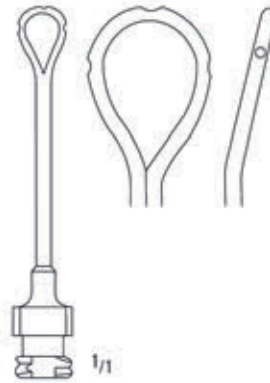

**JENSEN**  
KP 767/27  
4,5 cm/2"  
27G



L(mm)	B(mm)	H(mm)	
485	255	50	SK 305/05



Contents:		Qty
AA 060/05	DIEFFENBACH BULLDOG CLAMPS STR 5,0 CM	2
AA 150/14	HALSTED-MOSQUITO ART.FCPS STR 14,0 CM	1
AA 751/15	BACKHAUS TOWEL FORCEPS 15,0 CM	2
AB 714/10	GRAEFE IRIS FORCEPS STR 1X2 TEETH 10,0 CM	1
AB 750/07	BARRAQUER-KATZIN FIX.FCPS 1X2 T. 7,0 CM	1
AB 767/02	CASTROVIEJO CAPSULAR FCPS CROSSED 10,0 CM	1
AB 768/01	ARRUGA CAPSULAR FCPS NOT CALIBR. 10,0 CM	1
AB 792/11	ELSCHNIG FIXATION FORCPES 1X2 TEETH 11,0 CM	1
AB 819/02	MCPHERSON TYING FORCEPS ANGLED 10,5 CM	1
AB 825/02	BONN SUTURE FORCEPS 10,0 CM ULRTA FINE	1
AB 848/11	FAULKNER LENS HOLDING FORCEPS 11,0 CM	2
AB 852/02	MCDONALD IOL CAPSULORHEXIS FORCEPS 10,0 CM	1
AC 431/08	MOD.BONN SCISSORS CVD 8,0 CM	1
AC 776/04	VANNAS MOD.TÜBINGEN ANGLED O.FL. 8,5 CM	1
AC 778/03	VANNAS SEC.CATARACT SCISSORS,ANGULAR, 8,0 CM	1
AC 782/11	WESTCOTT TENOTOMY SCISSORS BLUNT 11,0 CM	1
AD 075/11	PCK=100 BLADES FIG.11	1
AD 550/09	BLADE BREAKER 9.0 CM DIA 5,5 MM	1
AD 551/09	BLADE BREAKER CVD 9.0 CM DIA 5,5 MM	1
AE 605/14	BARRAQUER MICRO-NEEDLE HOLDER CVD 14,0 CM	1
AE 660/14	CASTROVIEJO NH STR RA SMOOTH 14,0 CM	1
AE 688/14	KALT MICRO-NEEDLE HOLDER STR 14,0 CM	1
AR 282/20	CASTROVIEJO CIRCLE 8,0 CM STRAIGHT	1
KP 030/13	HIRSCHMANN IRIS HOOK 12,5 CM 45°	1
KP 040/02	JAFFE-BECHERT LENS NUCLEUS ROTATOR 12,0 CM	1
KP 067/60	NAGAHARA PHACO SPLITTER 12,0 CM 60°	1
KP 071/25	SINSKEY LENS MANIPULATOR 12,0 CM	1
KP 154/04	BARRAQUER PHACO EYE SPECULA 4,0 CM	1
KP 210/02	LIEBERMAN EYE SPECULA 15 MM K-SHAPE 8,0 CM	1
KP 335/12	MOD. HAMBURG KERATOME 12,0 CM	1
KP 370/04	PREMIUM DIAMOND KNIFE ANGLED LANCE 1,4 CM	1
KP 371/01	PREMIUM DIAMOND KNIFE STR.TRI-FACET 1,0 CM	1
KP 371/02	PREMIUM DIAMOND KNIFE ANGLED 2,0 CM	1
KP 545/02	MALONEY KERATOMETER INTRAOPERATIVE 2,0 CM	1
KP 550/12	THORNTON FIXATION RING FG-HINGE Ø13,0 MM	1
KP 700/00	BISHOP-HARMON ANTERIOR CHAMBER	1
KP 712/27	MCINTYRE ANTERIOR CHAMBER CANNULA 27G	1
KP 731/27	SAUTTER AIR INJECTION CANNULA 27G 3,5 CM	1
KP 767/27	JENSEN CAPSULE POLISHER 27G DIAMOND	2
SK 305/05	WIRE BASKET, 485 X 255 X 50 MM	1

Sterilization Container KYE 200/61, if required

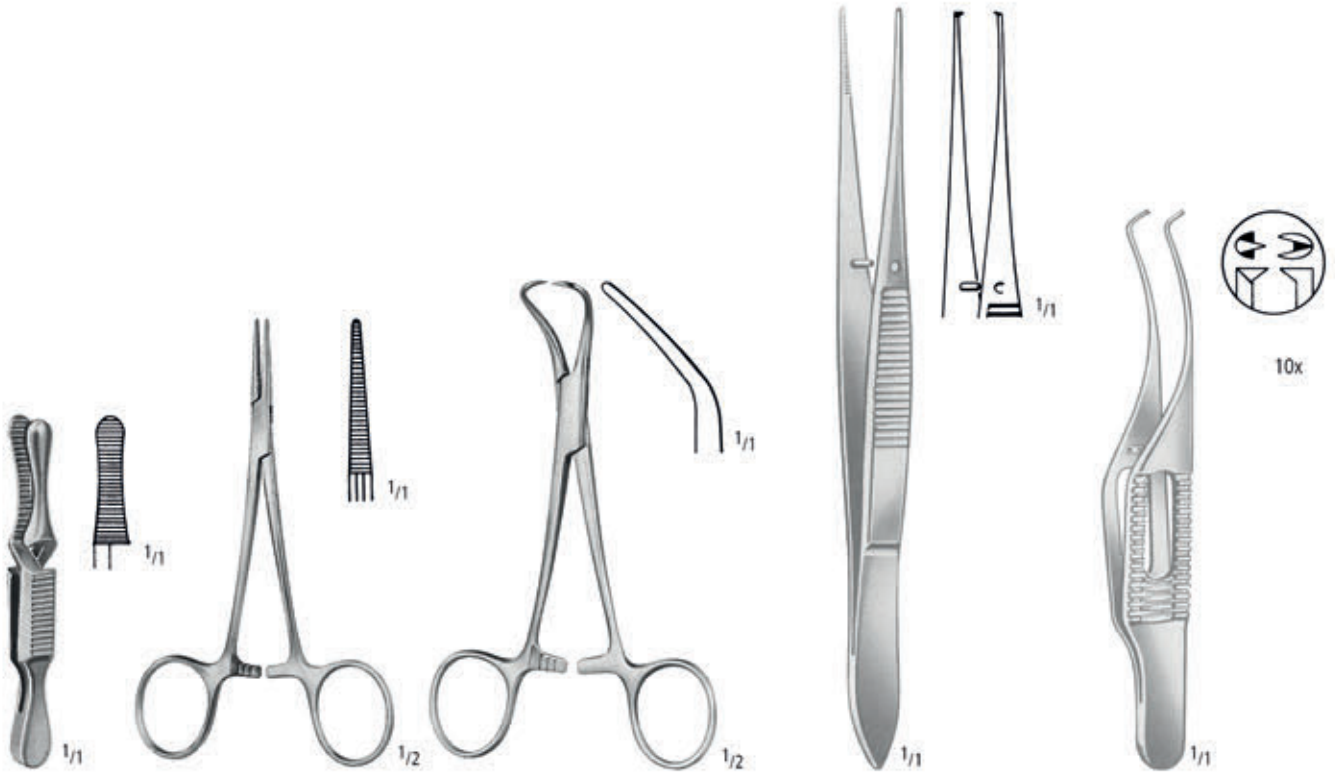

**DIEFFENBACH**  
AA 060/05  
5,0 cm/2"

**HALSTED-MOSQUITO**  
AA 150/14  
14,0 cm/5 1/2"

**BACKHAUS**  
AA 751/15  
15,0 cm/6"

**GRAEFE**  
AB 714/10  
10,0 cm/4"

**BARRAQUER-KATZIN 1:2 (Colibri)**  
AB 750/07  
7,0 cm/2 3/4"

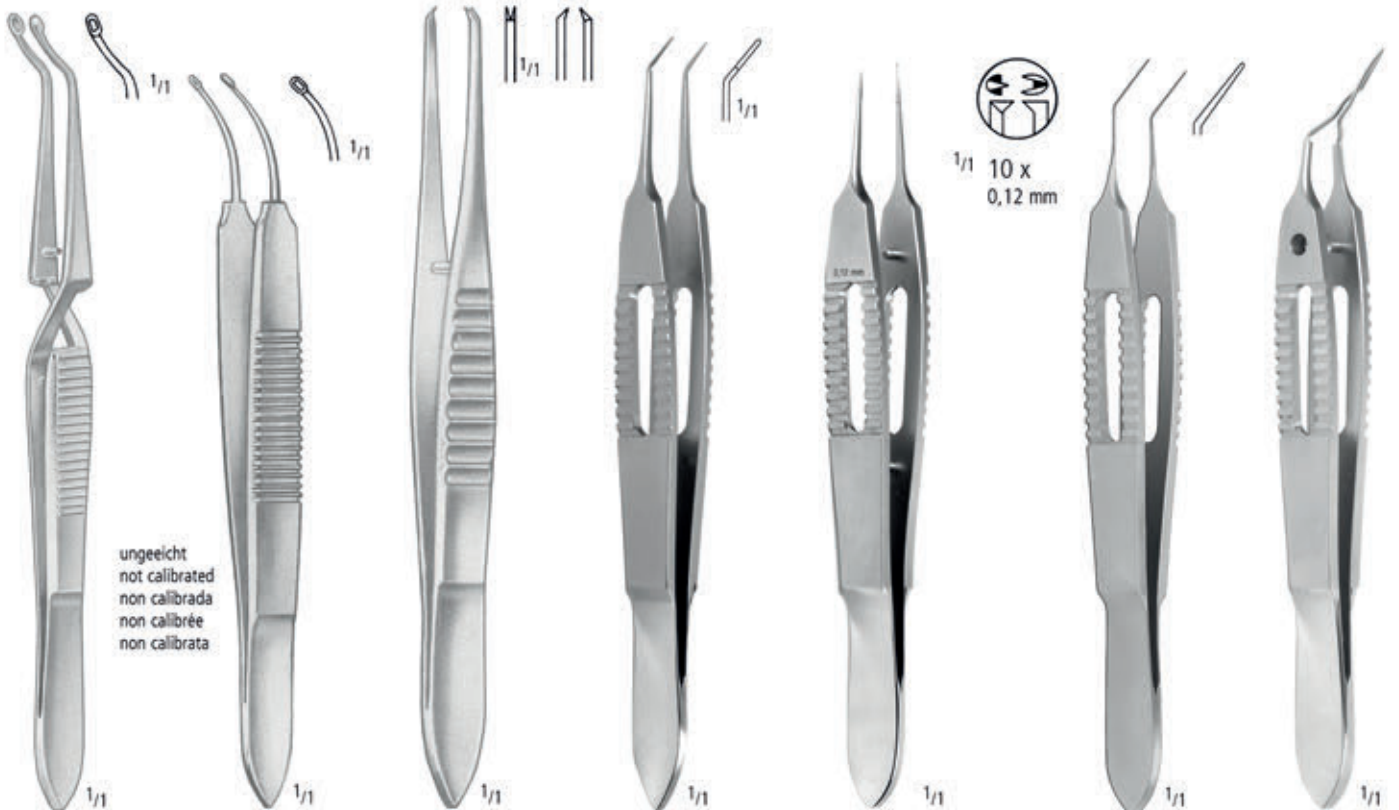

**CASTROVIEJO**  
AB 767/02  
10,0 cm/4"

**ARRUGA**  
AB 768/01  
10,0 cm/4"

**ELSCHMIG 1:2**  
AB 792/11  
11,0 cm/4 1/3"

**McPHERSON**  
AB 819/02  
10,0 cm/4"

**MOD. BONN**  
AB 825/02  
10,0 cm/4"

**FAULKNER**  
AB 848/11  
11,0 cm/4 1/3"

**McDONALD**  
AB 852/02  
10,0 cm/4"

sehr fein  
extra delicate  
muy finas  
très fin  
molto sottile

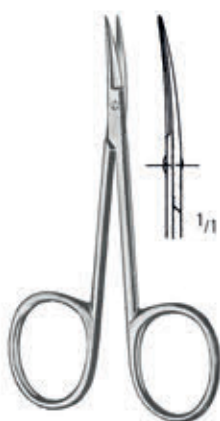

**MOD. BONN**  
AC 431/08  
8,0 cm/3"

aufgewinkelt  
angled on flat  
acodadas hacia arriba  
coudés vers le haut  
angolato in alto



**VANNAS MOD. TÜBINGEN**  
AC 776/04  
8,5 cm/3 1/3"

kniegebogen  
angular  
acodadas  
coudés  
angolato



**VANNAS**  
AC 778/03  
8,0 cm/3"



**WESTCOTT**  
AC 782/11  
11,0 cm/4 1/3"

Fig. 15  
AD 075/15

steril  
sterile  
estériles  
stériles  
sterili



**TROUTMAN-CHRIS**  
AD 550/09  
Ø 5,5 mm  
9,0 cm/3 1/2"



**TROUTMAN-CHRIS**  
AD 551/09  
Ø 5,5 mm  
9,0 cm/3 1/2"



**BARRAQUER**  
AE 605/11  
11,0 cm/4 1/3"



**CASTROVIEJO**  
AE 660/14  
14,0 cm/5 1/2"



**KALT**  
AE 688/14  
14,0 cm/5 1/2"



**CASTROVIEJO**  
AR 282/20  
8,0 cm/ 3"

Messbereich 20 mm  
measuring range 20 mm  
campo de medición 20 mm  
étendue de mesurage 20 mm  
ampiezza di misura 20 mm



**HIRSCHMANN**  
KP 030/13  
12,5 cm/5"



V-Spitze  
V-tip  
punta V  
coudé à fourche  
punta V

**JAFFE-BECHERT**  
KP 040/02  
12,0 cm/4<sup>3</sup>/<sub>4</sub>"  
L = 9 mm



Klinge  
blade  
hoja  
lame  
lame  
stumpfes Eck  
blunt edge  
canto romo  
coin mousse  
angolo smussato

**NAGAHARA**  
KP 067/60  
12,0 cm/4<sup>3</sup>/<sub>4</sub>"  
60°

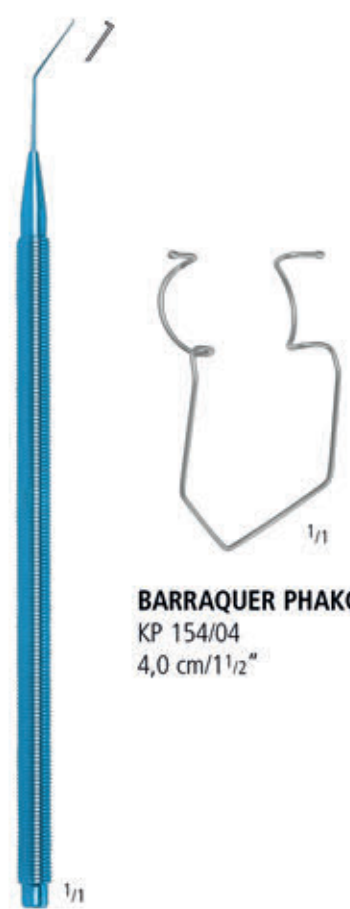

**BARRAQUER PHAKO**  
KP 154/04  
4,0 cm/1<sup>1</sup>/<sub>2</sub>"



**LIEBERMAN**  
KP 210/02  
8,0 cm/3<sup>1</sup>/<sub>4</sub>"  
B = 15 mm

K-förmig  
K-shaped  
forma K  
forme K  
forme K

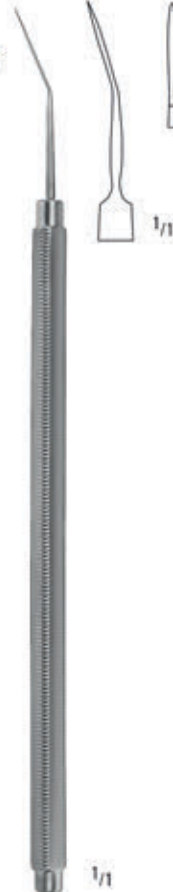

**MOD. HAMBURG**  
KP 335/12  
12,0 cm/ 4<sup>3</sup>/<sub>4</sub>"

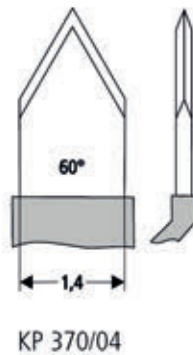

**SINSKEY**  
KP 071/25  
12,0 cm/4<sup>3</sup>/<sub>4</sub>"  
Ø 0,25 mm

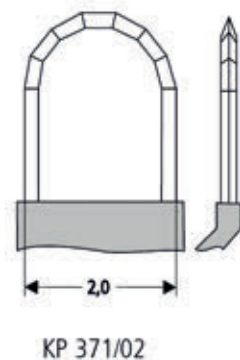
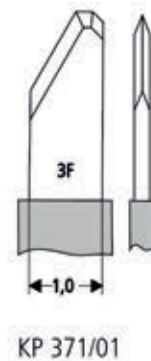



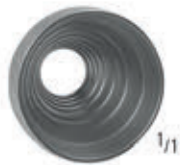

**MALONEY**  
 KP 545/02  
 2,0 cm/3/4"

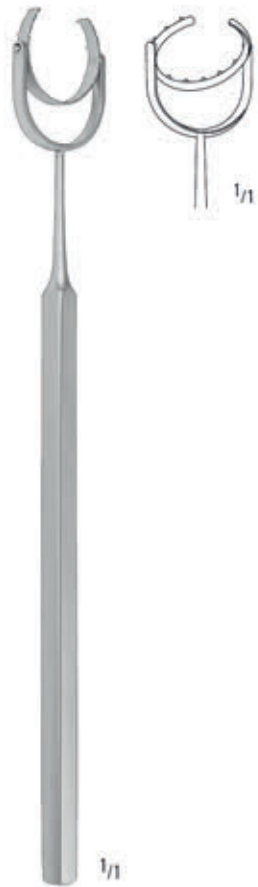

**THORNTON**  
 KP 550/12  
 12,0 cm/4 3/4"  
 Ø 13 mm



**BISHOP-HARMON**  
 KP 700/00



**SAUTTER**  
 KP 731/27  
 3,5 cm/1 1/2"  
 27G

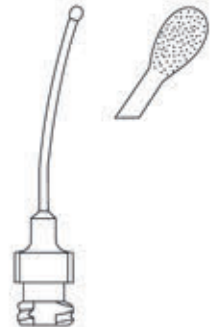

**JENSEN**  
 KP 767/27  
 4,5 cm/2"  
 27G

Set komplett  
 Set complete  
 Juego completo  
 Jeu complet  
 Set completo

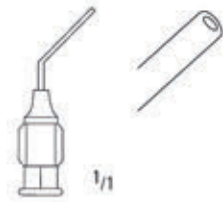

**McINTYRE**  
 2,5 cm/1"  
 KP 712/27  
 27G

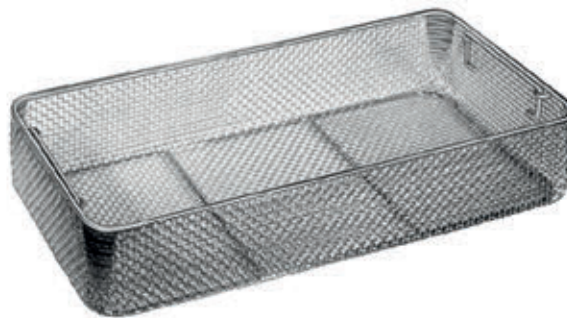

L(mm)	B(mm)	H(mm)	
485	255	50	SK 305/05



Contents:		Qty
AA 150/14	HALSTED-MOSQUITO ART.FCPS STR 14,0 CM	1
AA 751/15	BACKHAUS TOWEL FORCEPS 15,0 CM	2
AB 714/10	GRAEFE IRIS FORCEPS STR 1X2 TEETH 10,0 CM	1
AB 750/07	BARRAQUER-KATZIN FIX.FCPS 1X2 T. 7,0 CM	1
AB 792/11	ELSCHNIG FIXATION FORCPES 1X2 TEETH 11,0 CM	1
AB 816/10	CASTROVIEJO SUTURE FORCEPS 1.0MM 10,0 CM	1
AB 825/02	BONN SUTURE FORCEPS 10,0 CM ULRTA FINE	2
AC 431/08	MOD.BONN SCISSORS CVD 8,0 CM	1
AC 778/01	VANNAS SEC.CATARACT SCISSORS,STR. 8,0 CM	1
AC 782/11	WESTCOTT TENOTOMY SCISSORS BLUNT 11,0 CM	1
AC 785/01	CASTROVIEJO DELICATE EYE SCS.10,0 CM RIGHT	1
AC 791/01	KATZIN MICRO SCISSORS LEFT 11,0 CM	1
AC 791/02	KATZIN MICRO SCISSORS RIGHT 11,0 CM	1
AE 605/14	BARRAQUER MICRO-NEEDLE HOLDER CVD 14,0 CM	1
AE 660/14	CASTROVIEJO NH STR RA SMOOTH 14,0 CM	1
AE 688/14	KALT MICRO-NEEDLE HOLDER STR 14,0 CM	1
KP 150/15	BARRAQUER-COLIBRI EYE SPECULA 15 MM 4,0 CM	1
KP 325/05	BONN SCLERA KNIFE 5MM 12,5 CM	1
KP 370/02	PREMIUM DIAMOND KNIFE STR. 1,0 CM 45°	1
KP 508/10	BORES AXIS MARKER 10,0 CM	1
KP 535/12	ANIS SUTURE PLACEMENT MARKER 8 BLADES	1
KP 545/02	MALONEY KERATOMETER INTRAOPERATIVE 2,0 CM	1
KP 603/70	FRANCESCHETTI CERATOPLASTY TREPHINE	1
KP 603/80	FRANCESCHETTI CERATOPLASTY TREPHINE	1
KP 640/14	FLIERINGA SCLERAL FIXATION RING Ø 14,0 MM	1
KP 640/16	FLIERINGA SCLERAL FIXATION RING Ø 16,0 MM	1
KP 640/18	FLIERINGA SCLERAL FIXATION RING Ø 18,0 MM	1
KP 640/20	FLIERINGA SCLERAL FIXATION RING Ø 20,0 MM	1
KP 700/00	BISHOP-HARMON ANTERIOR CHAMBER	1
KP 731/27	SAUTTER AIR INJECTION CANNULA 27G 3,5 CM	2
SK 305/05	WIRE BASKET, 485 X 255 X 50 MM	1

Sterilization Container KYE 200/61, if required



**HALSTED-MOSQUITO**  
AA 150/14  
14,0 cm/5<sup>1</sup>/<sub>2</sub>"



**BACKHAUS**  
AA 751/15  
15,0 cm/6"



**GRAEFE**  
AB 714/10  
10,0 cm/4"



**BARRAQUER-KATZIN 1:2 (Colibri)**  
AB 750/07  
7,0 cm/2<sup>3</sup>/<sub>4</sub>"



**ELSCHMIG 1:2**  
AB 792/11  
11,0 cm/4<sup>1</sup>/<sub>3</sub>"



**CASTROVIEJO 1:2**  
AB 816/10  
1,00 mm  
10,0 cm/4"



**MOD. BONN**  
AB 825/02  
10,0 cm/4"

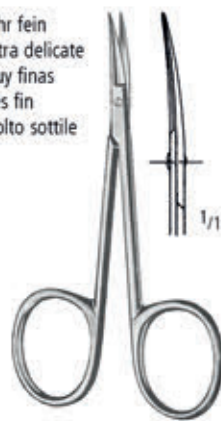

**MOD. BONN**  
AC 431/08  
8,0 cm/3"



**VANNAS**  
AC 778/01  
8,0 cm/3"



**WESTCOTT**  
AC 782/11  
11,0 cm/4<sup>1</sup>/<sub>3</sub>"



**CASTROVIEJO**  
AC 785/01  
10,0 cm/4"

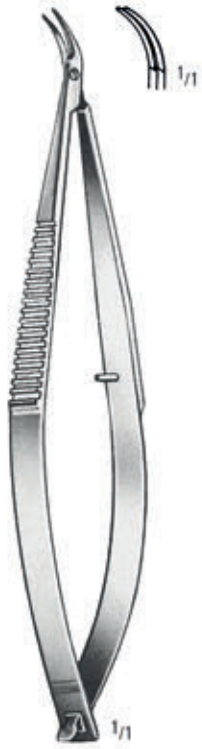

**KATZIN**  
AC 791/01  
11,0 cm/4<sup>1</sup>/<sub>3</sub>"

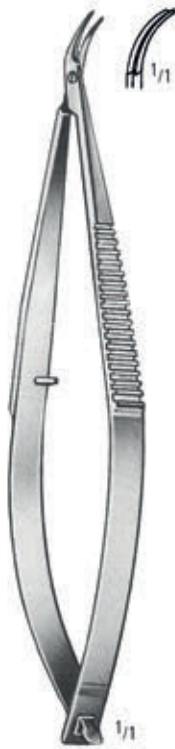

**KATZIN**  
AC 791/02  
11,0 cm/4<sup>1</sup>/<sub>3</sub>"



**BARRAQUER**  
AE 605/11  
11,0 cm/4<sup>1</sup>/<sub>3</sub>"



**CASTROVIEJO**  
AE 660/14  
14,0 cm/5<sup>1</sup>/<sub>2</sub>"



**KALT**  
AE 688/14  
14,0 cm/5<sup>1</sup>/<sub>2</sub>"



**BARRAQUER-COLIBRI**  
**B**  
15 mm KP 150/15  
4,0 cm/1<sup>1</sup>/<sub>2</sub>"

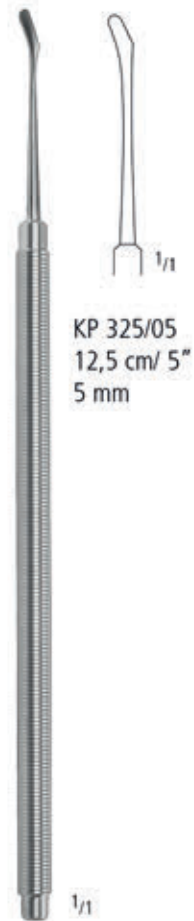

**BONN**

KP 325/05  
12,5 cm/ 5"  
5 mm



KP 370/02

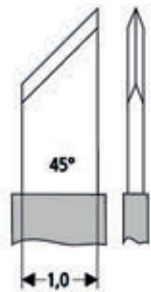

**BORES**  
KP 508/10  
10,0 cm/4"



**ANIS**  
KP 535/12  
12,0 cm/4<sup>3</sup>/<sub>4</sub>"



**MALONEY**  
KP 545/02  
2,0 cm/3<sup>1</sup>/<sub>4</sub>"



mm Ø  
7,0 KP 603/70  
8,0 KP 603/80  
**FRANCESCETTI**  
7,5 cm/3"

Set komplett  
Set complete  
Juego completo  
Jeu complet  
Set completo



1/1

**FLIERINGA**

mm Ø

- 14 KP 640/14
- 16 KP 640/16
- 18 KP 640/18
- 20 KP 640/20



1/2

**BISHOP-HARMON**  
KP 700/00



1/1

**SAUTTER**  
KP 731/27  
3,5 cm/1 1/2"  
27G

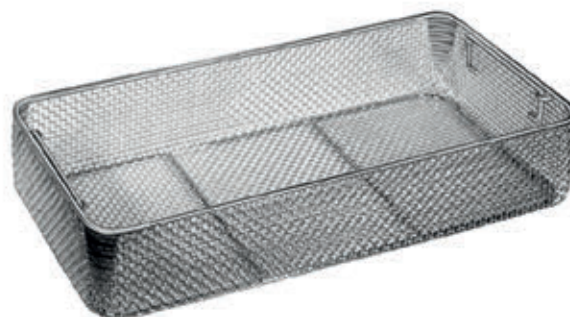

L(mm)	B(mm)	H(mm)	
485	255	50	SK 305/05

Contents:		Qty
<b>AB 750/07</b>	BARRAQUER-KATZIN FIX.FCPS 1X2 T. 7,0 CM	1
<b>KP 154/04</b>	BARRAQUER PHACO EYE SPECULA 4,0 CM	1
<b>KP 375/01</b>	PREMIUM DIAMOND KNIFE 1,0 CM 15°	1
<b>KP 500/70</b>	HOFFER OPTICAL ZONE MARKER 7,0 MM 10,0 CM	1
<b>KP 500/80</b>	HOFFER OPTICAL ZONE MARKER 8,0 MM 10,0 CM	1
<b>KP 508/10</b>	BORES AXIS MARKER 10,0 CM	1
<b>KP 515/12</b>	LINDSTROM CORNEAL OPTICAL ZONE MARKER	1
<b>KP 547/11</b>	MENDEZ MEASURING INSTRUMENT DEGREE 10°C	1
<b>KP 550/12</b>	THORNTON FIXATION RING FG-HINGE Ø 13,0 MM	1
<b>KP 741/23</b>	LACRIMAL CANNULA 23G 4,0 CM CURVED	2
<b>SK 105/05</b>	WIRE BASKET, 255 X 245 X 50 MM	1

Sterilization Container KYE 200/11, if required



**BARRAQUER-KATZIN 1:2 (Colibri)**  
AB 750/07  
7,0 cm/2<sup>3</sup>/<sub>4</sub>"



**BARRAQUER PHAKO**  
KP 154/04  
4,0 cm/1<sup>1</sup>/<sub>2</sub>"

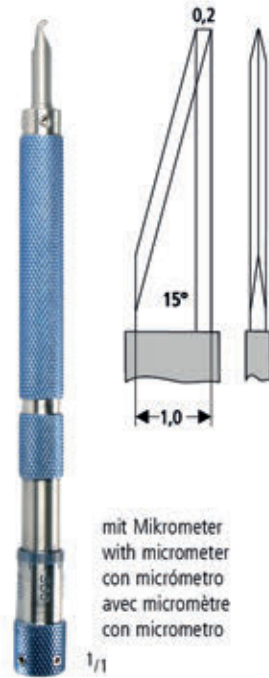

KP 375/01

mit Mikrometer  
with micrometer  
con micrómetro  
avec micromètre  
con micrometro



**HOFFER**  
10,0 cm/4"  
Ø 7,00 mm  
Ø 8,00 mm

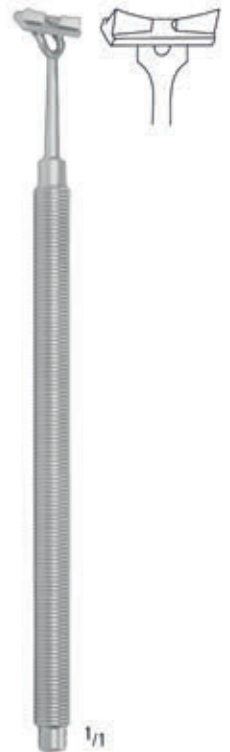

**BORES**  
KP 508/10  
10,0 cm/4"

KP 500/70  
KP 500/80

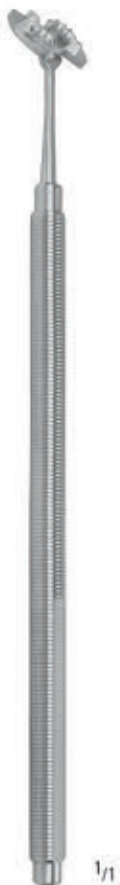

**LINDSTROM**  
KP 515/12  
12,0 cm/4<sup>3</sup>/<sub>4</sub>"  
7 mm



**MENDEZ**  
KP 547/11  
11,0 cm/4<sup>1</sup>/<sub>2</sub>"  
C 10°, 0 -180°



**THORNTON**  
KP 550/12  
12,0 cm/4<sup>3</sup>/<sub>4</sub>"  
Ø 13 mm



KP 741/23  
3,5 cm/1<sup>1</sup>/<sub>2</sub>"  
23G



L(mm)	B(mm)	H(mm)	
255	245	50	SK 105/05



Contents:		Qty
AA 060/06	DIEFFENBACH BULLDOG CLAMPS STR 6,0 CM	2
AA 151/12	HALSTED-MOSQUITO FCPS CVD 12,5 CM	1
AA 751/08	BACKHAUS TOWEL FORCEPS 8,0 CM	2
AB 710/07	GRAEFE IRIS FORCEPS STR SERR. 7,0 CM	1
AB 714/07	GRAEFE IRIS FORCEPS STR 1X2 TEETH 700 CM	1
AB 750/07	BARRAQUER-KATZIN FIX.FCPS 1X2 T. 7,0 CM	1
AB 792/11	ELSCHNIG FIXATION FORCPES 1X2 TEETH 11,0 CM	1
AB 816/01	CASTROVIEJO SUTURE FORCEPS 0,12 MM 10,0CM	1
AB 825/02	BONN SUTURE FORCEPS 10,0 CM ULRTA FINE	1
AB 825/02	BONN SUTURE FORCEPS 10,0 CM ULRTA FINE	1
AB 828/10	PAUFIQUE SUTURE FORCEPS 1X2 TEETH 10,0 CM	1
AB 833/01	JAMESON MUSCULAR FORCEPS 10,0 CM RIGHT	1
AB 833/02	JAMESON MUSCULAR FORCEPS 10,0 CM LEFT	1
AC 461/11	STRABISMUS SCISSORS CVD BLUNT 11,5 CM	1
AC 466/10	IRIS SCISSORS STR W LARGE BOWS 10,0 CM	1
AC 768/05	BARRAQUER EYE SCISSORS 5,5 CM 5,0 MM	1
AC 780/11	WESTCOTT TENOTOMY SCS.POINTED 11,0 CM	1
AC 782/11	WESTCOTT TENOTOMY SCISSORS BLUNT 11,0 CM	1
AD 075/11	PCK=100 BLADES FIG. 11	1
AD 550/09	BLADE BREAKER 9.0 CM DIA 5,5 MM	1
AE 605/14	BARRAQUER MICRO-NEEDLE HOLDER CVD 14,0 CM	1
AE 607/14	BARRAQUER MICRO-NH CVD RA 14,0 CM	1
AE 652/09	CASTROVIEJO NH STR RA 9,0 CM	1
AR 250/15	MEASURING INSTRUMENT 15,0 CM	1
AR 282/20	CASTROVIEJO CIRCLE 8,0 CM STRAIGHT	1
KP 001/13	GREEN STRABISMUS HOOK 13,0 CM	1
KP 002/12	JAMESON MUSCLE HOOK 12,0 CM	1
KP 010/14	GASS RETINAL DETACHMENT HOOK 14,0 CM	1
KP 015/01	GRAEFE STRABISMUS HOOK #1 13,0 CM	1
KP 015/02	GRAEFE STRABISMUS HOOK #2 14,0 CM	1
KP 015/03	GRAEFE STRABISMUS HOOK #3 15,0 CM	1
KP 150/15	BARRAQUER-COLIBRI EYE SPECULA 15 MM 4,0 CM	1
KP 261/15	SAUTTER ORBITAL SPATUL MEDIUM 15,0 CM	1
KP 495/13	WECKER IRIS SPATULA 2MM SILVER 13,0 CM	1
KP 542/01	SCHIOETZ TONOMETER STRAIGHT SCALE	1
SK 305/05	WIRE BASKET, 485 X 255 X 50 MM	1

Sterilization Container KYE 200/61, if required



**DIEFFENBACH**



**HALSTED-MOSQUITO**  
AA 151/12  
12,5 cm/5"



**BACKHAUS**  
AA 751/08  
8,0 cm/3"



**GRAEFE**



AB 710/07  
7,0 cm/2¾"



AB 714/07  
7,0 cm/2¾"



**BARRAQUER-KATZIN 1:2 (Colibri)**  
AB 750/07  
7,0 cm/2¾"



**ELSCHNIG 1:2**  
AB 792/11  
11,0 cm/4⅓"



**CASTROVIEJO 1:2**  
AB 816/01 0,12 mm  
10,0 cm/4"



10 x  
0,12 mm



**MOD. BONN**  
AB 825/02  
10,0 cm/4"



**PAUFIQUE 1:2**  
AB 828/10  
10,0 cm/4"

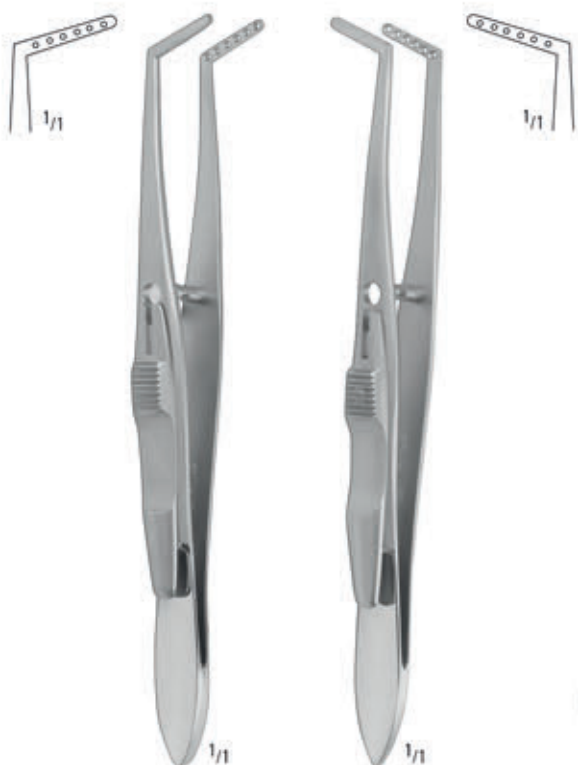

Strabismusscheren  
 Strabismus Scissors  
 Tijeras para estrabismos  
 Ciseaux à strabisme  
 Forbici per strabismo

mit großen Ringen  
 with large bows  
 con anillos grandes  
 avec grands anneaux  
 con anelli grandi



**JAMESON**  
 AB 833/01  
 10,0 cm/4"

**JAMESON**  
 AB 833/02  
 10,0 cm/4"

AC 461/11  
 11,5 cm/4 1/2"

AC 466/10  
 10,0 cm/4"

**BARRAQUER**  
 5,5 cm/2 1/4"  
 AC 768/05  
 5 mm



Fig. 11  
 AD 075/11

steril  
 sterile  
 estériles  
 stériles  
 sterili

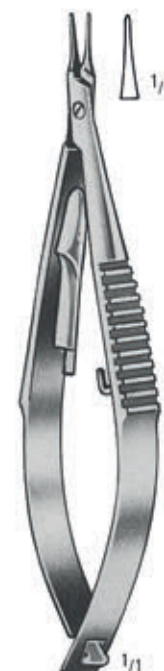

**WESTCOTT**  
 AC 780/11  
 11,0 cm/4 1/3"

**WESTCOTT**  
 AC 782/11  
 11,0 cm/4 1/3"

**TROUTMAN-CHRIS**  
 AD 550/09  
 Ø 5,5 mm  
 9,0 cm/3 1/2"

**BARRAQUER**  
 AE 605/14  
 14,0 cm/5 1/2"

**BARRAQUER**  
 AE 607/14  
 14,0 cm/5 1/2"

**CASTROVIEJO**  
 AE 652/09  
 9,0 cm/3 1/2"



Messbereich 20 mm  
 measuring range 20 mm  
 campo de medición 20 mm  
 étendue de mesurage 20 mm  
 ampiezza di misura 20 mm



AR 250/15  
 15,0 cm/6"

**CASTROVIEJO**  
 AR 282/20  
 8,0 cm/ 3"

Erwachsene  
 Adults  
 Adultos  
 Adultes  
 Adulti

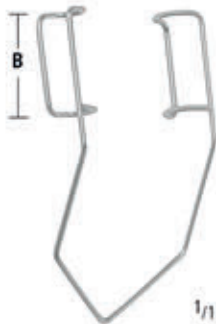

**BARRAQUER-COLIBRI**  
**B**  
 15 mm  
 KP 150/15  
 4,0 cm/1½"



**GREEN**  
 KP 001/13  
 13,0 cm/5"



**JAMESON**  
 KP 002/12  
 12,0 cm/4¾"



**GASS**  
 KP 010/14  
 14,0 cm/5½"



**GRAEFE**  
 KP 015/01  
 13,0 cm/5"  
 Fig. 1



**GRAEFE**  
 KP 015/02  
 14,0 cm/5½"  
 Fig. 2

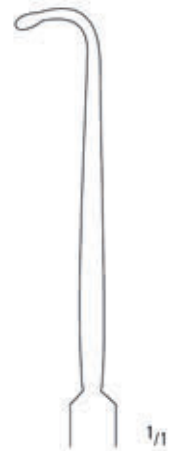

**GRAEFE**  
 KP 015/03  
 15,0 cm/6"  
 Fig. 3

ZS 160/55

NETZHAUTABLÖSUNG RETINAL DETACHMENT DESPRENDIMIENTO DE RETINA  
DÉCOLLEMENT DE LA RÉTINE DISTACCO DELLA RETINA



**SAUTER**  
KP 261/15  
15,0 cm/6"



**WECKER**  
KP 495/13  
13,0 cm/5"  
2 mm

biegsam  
malleable  
maleable  
malléable  
malleabile



gerade Skala  
straight scale  
graduado recto  
échelle droite  
scala retta

**SCHIOETZ**  
KP 542/01  
13,0 cm/5"

Spezifikation Nr. 5, geeicht  
Specification No. 5, calibrated  
Especificación No. 5, calibrada  
Spécification No. 5, calibrée  
Specifica No. 5, calibrata

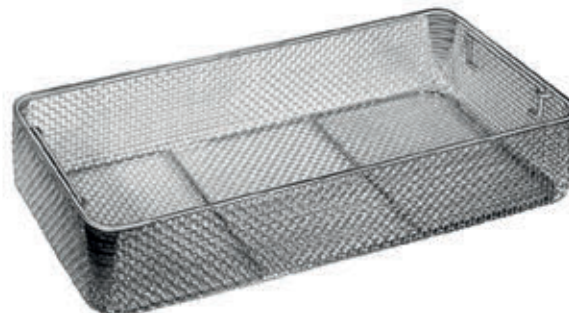

L(mm)	B(mm)	H(mm)	
485	255	50	SK 305/05



Contents:		Qty
AA 150/14	HALSTED-MOSQUITO ART.FCPS STR 14,0 CM	2
AA 151/14	HALSTED-MOSQUITO ART.FCPS CVD 14,0 CM	2
AA 711/09	JONES TOWEL FORCEPS 9,0 CM	2
AB 628/09	ZIEGLER CILIA FORCEPS 9,0 CM	1
AB 785/01	GRAEFE FIX.FCPS W/O SPRING CATCH 11,0 CM	1
AB 816/01	CASTROVIEJO SUTURE FORCEPS 10,0 CM	2
AB 824/02	BONACCOLTO SUTURE FORCEPS 10,0 CM FINE	1
AB 829/01	HARMS TYING FORCEPS STRAIGHT 10,0 CM	1
AB 840/01	DESMARRES CHALAZION FORCEPS FIG.1 9,0 CM	1
AB 841/01	LAMBERT CHALAZION FORCEPS 9,0 CM ROUND	1
AB 844/20	BERKE PTOSIS FORCEPS 11,0 CM, 20 MM	1
AC 450/10	IRIS SCISSORS STR SH/SH 10,5 CM	1
AC 475/10	STEVENS TENOTOM.SCS POINTED CVD 10,5 CM	1
AC 782/11	WESTCOTT TENOTOMY SCISSORS BLUNT 11,0 CM	1
AC 797/01	WESTCOTT STRABISMUS SCS STR SHARP 11,5 CM	1
AE 663/14	CASTROVIEJO NH CVD RA SERRATED 14,0 CM	1
AE 688/14	KALT MICRO-NEEDLE HOLDER STR 14,0 CM	1
AK 074/01	GUTHRIE DELICATE HOOK FIG.1 16,0 CM	1
AK 078/13	KNAPP DELICATE HOOK BLUNT 13,0 CM	1
AK 090/12	DESMARRES RETRACTOR 12 MM 13,0 CM	1
AK 090/14	DESMARRES RETRACTOR 14 MM 13,0 CM	1
AK 090/16	DESMARRES RETRACTOR 16 MM 13,0 CM	1
AR 282/20	CASTROVIEJO CIRCLE 8,0 CM STRAIGHT	1
KP 015/01	GRAEFE STRABISMUS HOOK #1 13,0 CM	1
KP 015/02	GRAEFE STRABISMUS HOOK #2 14,0 CM	1
KP 248/11	JAEGER LID PLATE 11,0 CM	1
KP 325/05	BONN SCLERA KNIFE 5MM 12,5 CM	1
KP 415/10	MEYHOEFER CHALAZION CURETTE 13,0 CM	1
KP 415/20	MEYHOEFER CHALAZIONCURETTE 13,0 CM 2,0 MM	1
KP 415/25	MEYHOEFER CHALAZIONCURETTE 13,0 CM 2,5 MM	1
KP 415/35	MEYHOEFER CHALAZIONCURETTE 13,0 CM 3,5 MM	1
KP 700/00	BISHOP-HARMON ANTERIOR CHAMBER	1
SK 305/05	WIRE BASKET, 485 X 255 X 50 MM	1

Sterilization Container KYE 200/61, if required

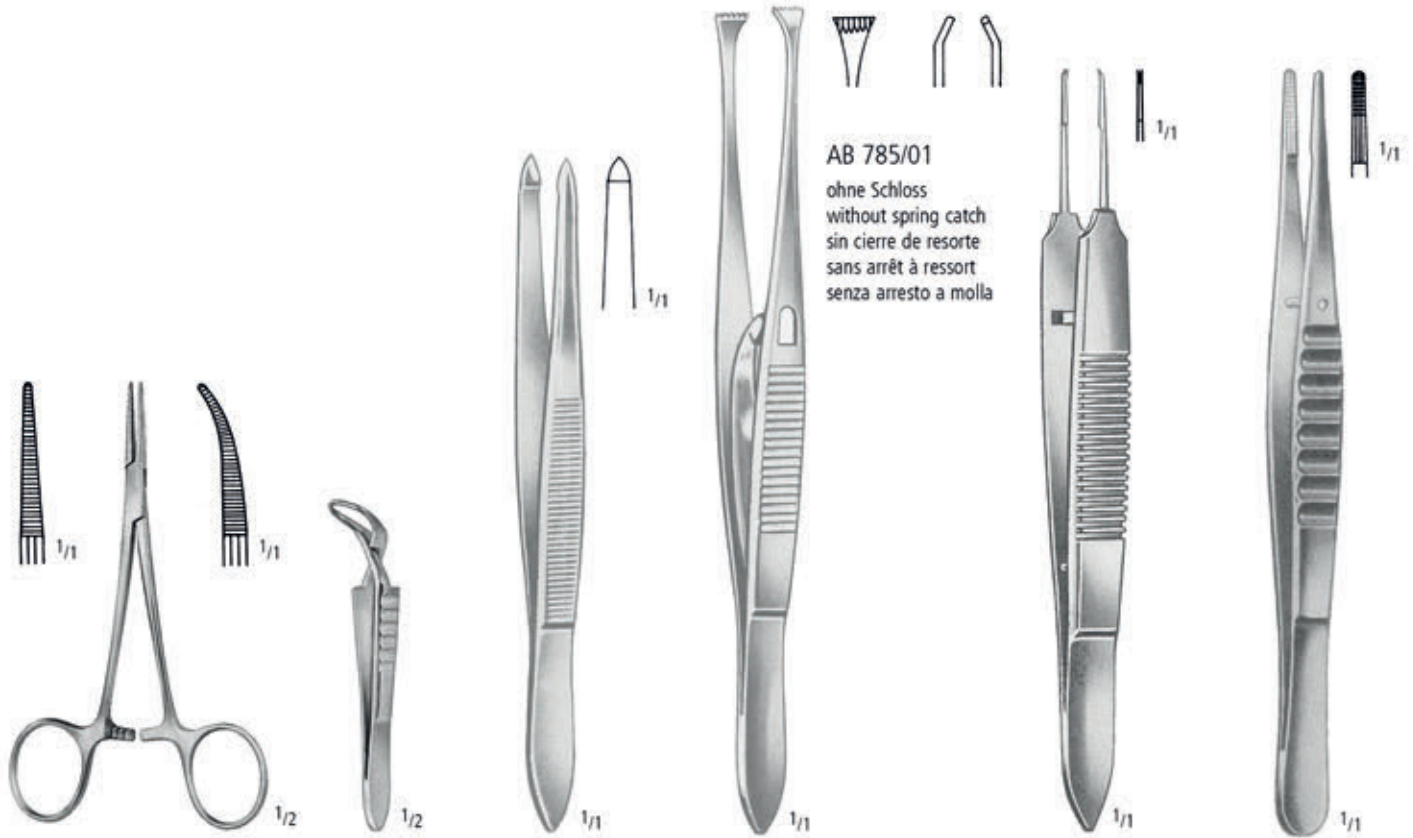

AB 785/01  
ohne Schloss  
without spring catch  
sin cierre de resorte  
sans arrêt à ressort  
senza arresto a molla

**HALSTED-MOSQUITO**  
AA 150/14 AA 151/14  
14,0 cm/5½"

**JONES**  
AA 711/09  
9,0 cm/3½"

**ZIEGLER**  
AB 628/09  
9,0 cm/3½"

**GRAEFE**  
11,0 cm/4⅓"

**CASTROVIEJO 1:2**  
AB 816/01  
0,12 mm  
10,0 cm/4"

**BONACCOLTO**  
AB 824/02  
10,0 cm/4"



**HARMS**  
AB 829/01  
10,0 cm/4"

**DESMARRES**  
AB 840/01  
9,0 cm/3½"

**LAMPERT**  
AB 841/01  
9,0 cm/3½"

**BERKE**  
AB 844/20  
11,0 cm/4⅓"  
20 mm



Irisscheren  
Iris Scissors  
Tijeras para iridectomia  
Ciseaux à iridectomie  
Forbici per iridectomia

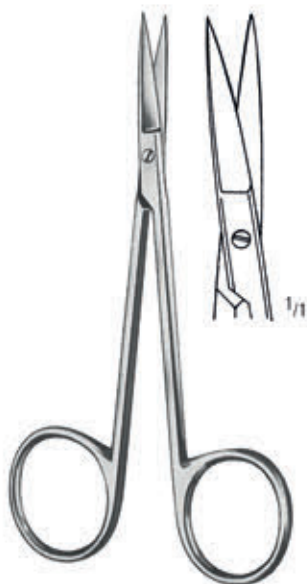

AC 450/10  
10,5 cm/4 1/4"

Sehnenscheren  
Tenotomy Scissors  
Tijeras para tenotomía  
Ciseaux à ténonomie  
Forbici per tenotomia

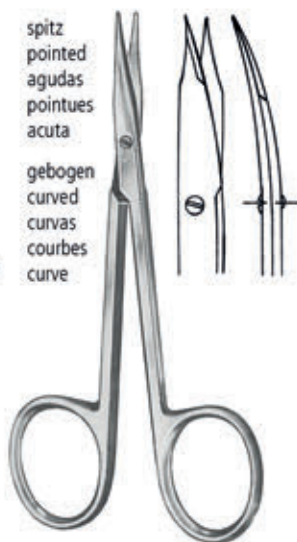

STEVENS  
AC 475/10  
10,5 cm/4 1/4"



WESTCOTT  
AC 782/11  
11,0 cm/4 1/3"



WESTCOTT  
AC 797/01  
11,5 cm/4 1/2"



CASTROVIEJO  
AE 663/14  
14,0 cm/5 1/2"



KALT  
AE 688/14  
14,0 cm/5 1/2"

spitz  
pointed  
agudas  
pointues  
acuta

gebogen  
curved  
curvas  
courbes  
curve

Messbereich 20 mm  
measuring range 20 mm  
campo de medición 20 mm  
étendue de mesurage 20 mm  
ampiezza di misura 20 mm



GUTHRIE  
AK 074/01  
16,0 cm/6 1/4"



KNAPP  
AK 078/13  
13,0 cm/5"



DESMARRES  
13,0 cm/5"



AK 090/12  
12 mm

AK 090/14  
14 mm

AK 090/16  
16 mm



CASTROVIEJO  
AR 282/20  
8,0 cm/ 3"

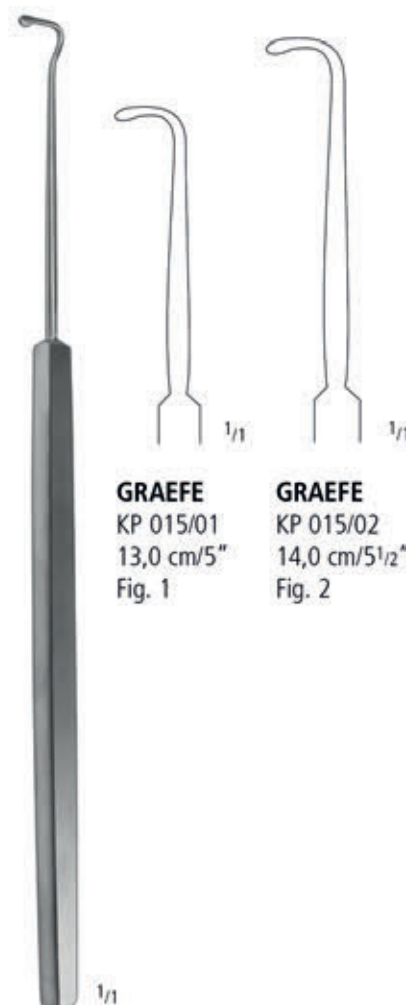

GRAEFE  
KP 015/01  
13,0 cm/5"  
Fig. 1

GRAEFE  
KP 015/02  
14,0 cm/5 1/2"  
Fig. 2



**JAEGER**  
KP 248/11  
11,0 cm/4 1/2"

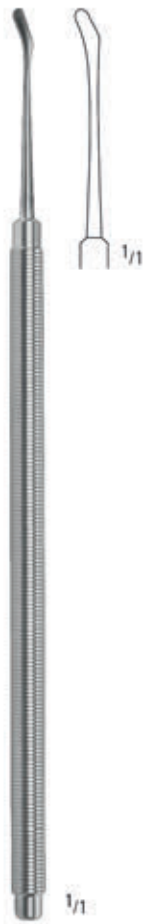

**BONN**  
KP 325/05  
12,5 cm/ 5"  
5 mm



**MEYHOEFER**  
13,0 cm/5"

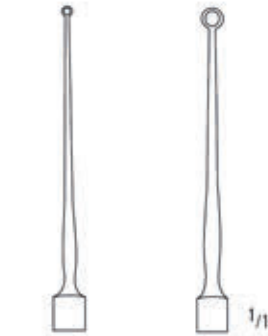

KP 415/10  
Ø 1,0 mm

KP 415/20  
Ø 2,0 mm

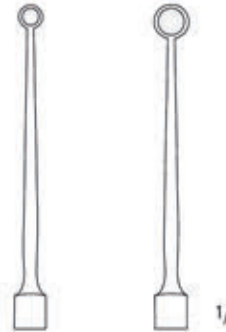

KP 415/25  
Ø 2,5 mm

KP 415/35  
Ø 3,5 mm

Set komplett  
Set complete  
Juego completo  
Jeu complet  
Set completo



**BISHOP-HARMON**  
KP 700/00

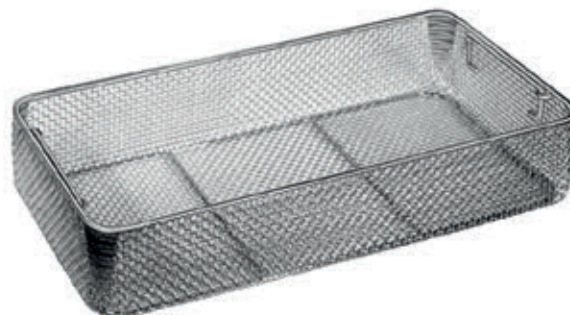

L(mm)	B(mm)	H(mm)	
485	255	50	SK 305/05

**ZS 160/65** PTERYGIUM PTERYGIUM PTERIGIÓN PTÉRYGION PTERIGIO

Contents:		Qty
<b>AB 710/10</b>	GRAEFE IRIS FORCEPS STR SERR. 10,0 CM	1
<b>AB 714/10</b>	GRAEFE IRIS FORCEPS STR 1X2 TEETH 10,0 CM	1
<b>AB 786/02</b>	GREEN FIXATION FORCEPS T-FORM 10,0 CM	1
<b>AB 828/10</b>	PAUFIQUE SUTURE FORCEPS 1X2 TEETH 10,0 CM	1
<b>AC 466/10</b>	IRIS SCISSORS STR W LARGE BOWS 10,0 CM	1
<b>AE 657/14</b>	CASTROVIEJO NH CVD SMOOTH 14,0 CM	1
<b>AK 090/10</b>	DESMARRES RETRACTOR 10 MM 13,0 CM	1
<b>KP 186/08</b>	LANCASTER EYE SPECULA 8,0 CM	1
<b>KP 325/05</b>	BONN SCLERA KNIFE 5MM 12,5 CM	1
<b>SK 105/05</b>	WIRE BASKET, 255 X 245 X 50 MM	

Sterilization Container KYE 200/11, if required



AB 710/10  
10,0 cm/4"



AB 714/10  
10,0 cm/4"

**GRAEFE**

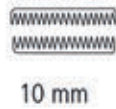

10 mm

**GREEN**  
AB 786/02  
10,0 cm/4"



**PAUFIQUE 1:2**  
AB 828/10  
10,0 cm/4"



mit großen Ringen  
with large bows  
con anillos grandes  
avec grands anneaux  
con anelli grandi

AC 466/10  
10,0 cm/4"

**CASTROVIEJO**  
AE 657/14  
14,0 cm/5 1/2"



10 mm

**DESMARRES**  
AK 090/10  
13,0 cm/5"



**LANCASTER**  
KP 186/08  
8,0 cm/3 1/4"

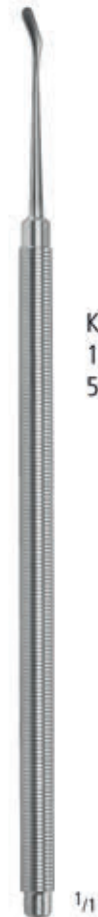

KP 325/05  
12,5 cm/ 5"  
5 mm

**BONN**



L(mm)	B(mm)	H(mm)	
255	245	50	SK 105/05

Contents:		Qty
AA 114/10	HARTMANN FORCEPS STR 10,0 CM	2
AA 115/10	HARTMANN FORCEPS CVD 10,0 CM	2
AA 751/08	BACKHAUS TOWEL FORCEPS 8,0 CM	2
AB 700/05	GRAEFE IRIS FCPS STR.SERRAT. 0,5 MM 7,0 CM	1
AB 816/01	CASTROVIEJO SUTURE FORCEPS 0,12MM 10,0 CM	1
AB 824/02	BONACCOLTO SUTURE FORCEPS 10,0 CM FINE	1
AB 828/10	PAUFIQUE SUTURE FORCEPS 1X2 TEETH 10,0 CM	1
AC 466/10	IRIS SCISSORS STR W LARGE BOWS 10,0 CM	1
AC 477/10	STEVENS TENOTOM.SCS BLUNT CVD 10,5 CM	1
AC 773/10	CASTROVIEJO IRIS SCISSORS 10,0 CM SH	1
AE 661/14	CASTROVIEJO NH CVD RA SMOOTH 14,0 CM	1
AK 077/13	KNAPP DELICATE HOOK SHARP 13,0 CM	1
KA 540/32	MEAD MALLETT 320GR MASSIV FERROZ.FAC.17,0 CM	1
KA 800/14	FRIEDMANN RONGEUR FORCEPS 14,0 CM	1
KO 050/01	HARTMANN-HALLE NASAL SPEC.15,0 CM FIG.1	1
KO 275/90	KERRISON ANTRUM RONGEUR FCPS 3X3 MM	1
KO 343/16	JOSEPH SEPTUM ELEVATOR 16,0 CM	1
KO 603/04	FREER CHISELS CURVED 16,0 CM	1
KO 604/04	WEST CHISELS 16,0 CM	1
KO 605/04	WEST GOUGES 16,0 CM	1
KP 114/00	BOWMAN LACRIMAL PROBE POINTED 12,5 CM	1
KP 115/00	BOWMAN LACRIMAL PROBE POINTED 12,5 CM	1
KP 115/12	BOWMAN LACRIMAL PROBE POINTED 12,5 CM	1
KP 115/34	BOWMAN LACRIMAL PROBE POINTED 12,5 CM	1
KP 115/56	BOWMAN LACRIMAL PROBE POINTED 12,5 CM	1
KP 123/14	CASTROVIEJO LACRIMAL DILATOR,14,0 CM D/E	1
KP 135/14	WORST PIGTAIL PROBE 13,5 CM	1
KP 230/08	STEVENS LACRIMAL SAC RETRACTOR 7,5 CM	1
KP 700/00	BISHOP-HARMON ANTERIOR CHAMBER	1
KP 740/23	ANEL LACRIMAL CANNULA 23G 4,0 CM	1
KP 741/23	LACRIMAL CANNULA 23G 4,0 CM CURVED	1
SK 305/05	WIRE BASKET, 485 X 255 X 50 MM	1

Sterilization Container KYE 200/61, if required



**HARTMANN**  
AA 114/10  
10,0 cm/4"



**HARTMANN**  
AA 115/10  
10,0 cm/4"



**BACKHAUS**  
AA 751/08  
8,0 cm/3"



**GRAEFE**  
0,5 mm  
AB 700/05  
7,0 cm/2<sup>3</sup>/<sub>4</sub>"



**CASTROVIEJO 1:2**  
AB 816/01  
0,12 mm  
10,0 cm/4"



**BONACCOLTO**  
AB 824/02  
10,0 cm/4"



**PAUFIGUE 1:2**  
AB 828/10  
10,0 cm/4"



AC 466/10  
10,0 cm/4"

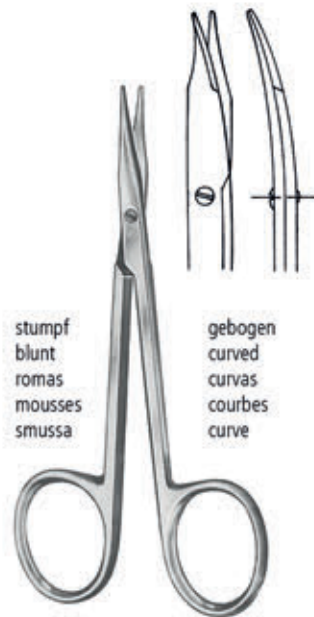

**STEVENS**  
AC 477/10  
10,5 cm/4<sup>1</sup>/<sub>4</sub>"

stumpf  
blunt  
romas  
mousses  
smussa

gebogen  
curved  
curvas  
courbes  
curve

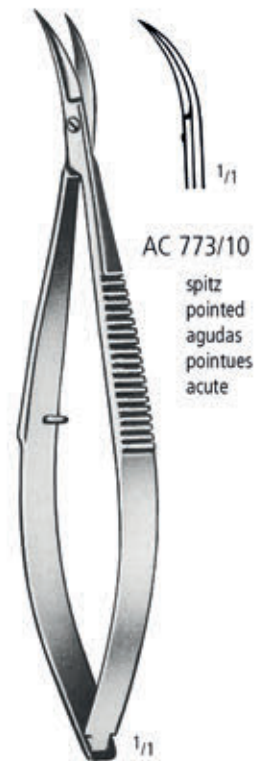

**CASTROVIEJO**  
10,0 cm/4"

AC 773/10  
spitz  
pointed  
agudas  
pointues  
acute



**CASTROVIEJO**  
 AE 661/14  
 14,0 cm/5½"



**KNAPP**  
 AK 077/13  
 13,0 cm/5"



**MEAD**  
 KA 540/32  
 17,0 cm/6¾"



**FRIEDMAN**  
 KA 800/14  
 14,0 cm/5½"



**HARTMANN-HALLE**  
 KO 050/01  
 15,0 cm/6"



**KERRISON**



**JOSEPH**  
 KO 343/16  
 16,0 cm/6¼"



**FREER**  
 KO 603/04  
 16,0 cm/6¼"



**WEST**  
 KO 604/04  
 16,0 cm/6¼"



**WEST**  
 KO 605/04  
 16,0 cm/6¼"



**BOWMAN**  
12,5 cm/5"



**CASTROVIEJO**  
KP 123/14  
14 cm/5 1/2"

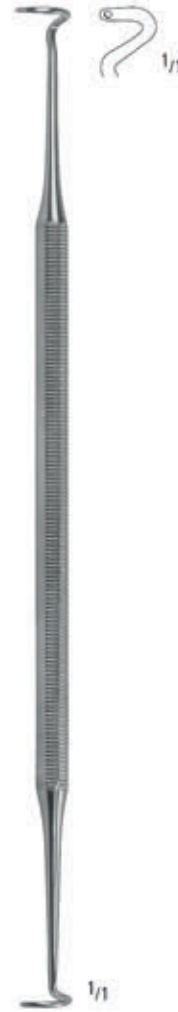

**WORST**  
KP 135/14  
13,5 cm/5 1/4"



**STEVENSON**  
KP 230/08  
7,5 cm/3"



**BISHOP-HARMON**  
KP 700/00

Set komplett  
Set complete  
Juego completo  
Jeu complet  
Set completo

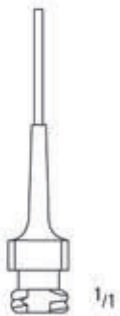

**ANEL**  
KP 740/23  
4,0 cm/1 1/2"  
23G



KP 741/23  
3,5 cm/1 1/2"  
23G

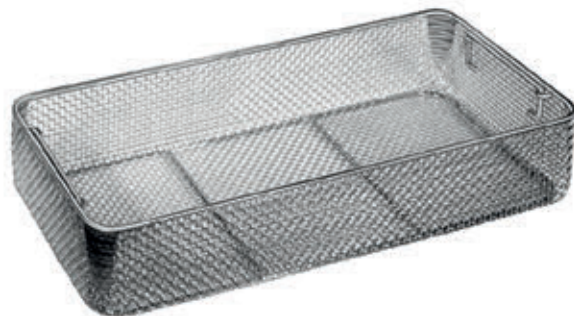

L(mm)	B(mm)	H(mm)	
485	255	50	SK 305/05



**ZS 160/75** LASIK LASIK LASIK LASIK LASIK

Contents:		Qty
<b>AB 819/02</b>	MCPHERSON TYING FORCEPS ANGLED 10,5 CM	1
<b>KP 210/02</b>	LIEBERMAN EYE SPECULA 15 MM K-SHAPE 8,0 CM	1
<b>KP 211/08</b>	LIEBERMAN EYE SPECULA 15 MM 8,0 CM ASP.	1
<b>KP 270/10</b>	LASIK FLAP SMOOTHER 10,0 CM	1
<b>KP 487/14</b>	CASTROVIEJO CYCLODIALYSIS SPATULA 13,5 CM	1
<b>KP 489/12</b>	BARRAQUER-FINO CYCLODIALYSIS SPATULA 11,5 CM	1
<b>KP 516/11</b>	LU CORNEAL MARKER LASIK Ø 8,5MM 10,5 CM	1
<b>KP 550/12</b>	THORNTON FIXATION RING FG-HINGE Ø 13,0 MM	1
<b>KP 701/19</b>	BISHOP-HARMON IRRIGATION CANNULA 19G 4,0 CM	1
<b>KP 731/27</b>	SAUTTER AIR INJECTION CANNULA 27G 3,5 CM	1
<b>SK 105/05</b>	WIRE BASKET, 255 X 245 X 50 MM	1

Sterilization Container KYE 200/11, if required



**McPHERSON**  
AB 819/02  
10,0 cm/4"



**LIEBERMAN**  
KP 210/02  
8,0 cm/3<sup>1</sup>/<sub>4</sub>"  
B = 15 mm



**LIEBERMAN**  
KP 211/08  
8,0 cm/3<sup>1</sup>/<sub>4</sub>"  
B = 15 mm



**LASIK**  
KP 270/10  
10,0 cm/4"

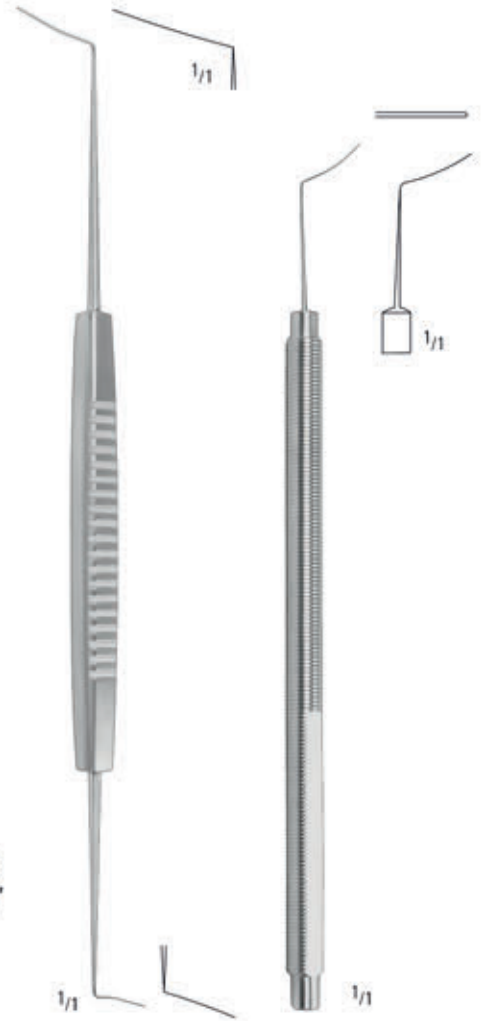

**CASTROVIEJO**  
KP 487/14  
13,5 cm/5<sup>1</sup>/<sub>4</sub>"  
0,5 x 10/16 mm

**BARRAQUER-FINO**  
KP 489/12  
11,5 cm/4<sup>1</sup>/<sub>2</sub>"  
0,25 x 12 mm

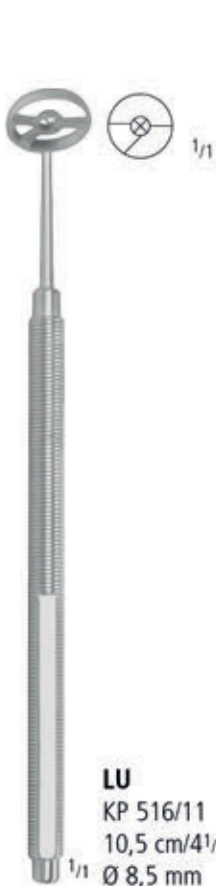

**LU**  
KP 516/11  
10,5 cm/4<sup>1</sup>/<sub>4</sub>"  
Ø 8,5 mm

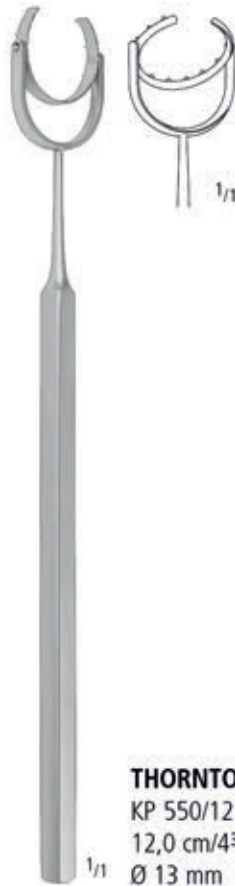

**THORNTON**  
KP 550/12  
12,0 cm/4<sup>3</sup>/<sub>4</sub>"  
Ø 13 mm

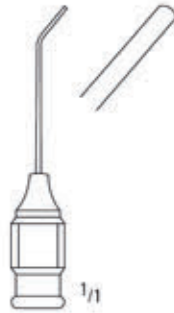

**BISHOP-HARMON**  
KP 701/19  
4,0 cm/1<sup>1</sup>/<sub>2</sub>"  
19G



**SAUTTER**  
KP 731/27  
3,5 cm/1<sup>1</sup>/<sub>2</sub>"  
27G



L(mm)	B(mm)	H(mm)	
255	245	50	SK 105/05

Contents:		Qty
<b>AB 752/07</b>	BARRAQUER-KATZIN IRIS FORCEPS 7,0 CM	1
<b>AB 820/10</b>	KELMAN-MCPHERSON TYING FORCEPS 10,0 CM	1
<b>KP 154/04</b>	BARRAQUER PHACO EYE SPECULA 4,0 CM	1
<b>KP 375/02</b>	PREMIUM DIAMOND KNIFE 1,0 CM 45°	1
<b>KP 500/30</b>	HOFFER OPTICAL ZONE MARKER 3,00 MM 10,0 CM	1
<b>KP 500/32</b>	HOFFER OPTICAL ZONE MARKER 3,25 MM 10,0 CM	1
<b>KP 500/40</b>	HOFFER OPTICAL ZONE MARKER 4.00 MM 10,0 CM	1
<b>KP 500/50</b>	HOFFER OPTICAL ZONE MARKER 5.00MM 10,0 CM	1
<b>KP 500/70</b>	HOFFER OPTICAL ZONE MARKER 7.00MM 10,0 CM	1
<b>KP 535/12</b>	ANIS SUTURE PLACEMENT MARKER 8 BLADES	1
<b>KP 548/50</b>	DEITZ DEPTH GAUGE 0,50 MM 9,5 CM	1
<b>KP 548/55</b>	DEITZ DEPTH GAUGE 0,55 MM 9,5 CM	1
<b>KP 550/12</b>	THORNTON FIXATION RING FG-HINGE Ø 13,0 MM	1
<b>KP 731/27</b>	SAUTTER AIR INJECTION CANNULA 27G 3,5 CM	2
<b>SK 105/05</b>	WIRE BASKET, 255 X 245 X 50 MM	1

Sterilization Container KYE 200/11, if required

ZS 160/80

RADIÄRE KERATOTOMIE  
KÉRATOTOMIE RADIALE

RADIALE KERATOTOMY  
CHERATOTOMIA RADIALE

QUERATOTOMÍA RADIAL



**BARRAQUER-KATZIN 1:2**  
(Colibri)  
AB 752/07  
7,0 cm/2<sup>3</sup>/<sub>4</sub>"



**BARRAQUER PHAKO**  
KP 154/04  
4,0 cm/1<sup>1</sup>/<sub>2</sub>"



mit Mikrometer  
with micrometer  
con micrómetro  
avec micromètre  
con micrometro

- Ø 3,00 mm
- Ø 3,25 mm
- Ø 4,00 mm
- Ø 5,00 mm
- Ø 7,00 mm



**HOFFER**  
10,0 cm/4"

**KELMAN-McPHERSON 1:2**  
AB 820/10  
10,0 cm/4"

KP 375/02



**ANIS**  
KP 535/12  
12,0 cm/4<sup>3</sup>/<sub>4</sub>"



**DEITZ**  
9,5 cm/3<sup>3</sup>/<sub>4</sub>"  
KP 548/50 0,50 mm  
KP 548/55 0,55 mm

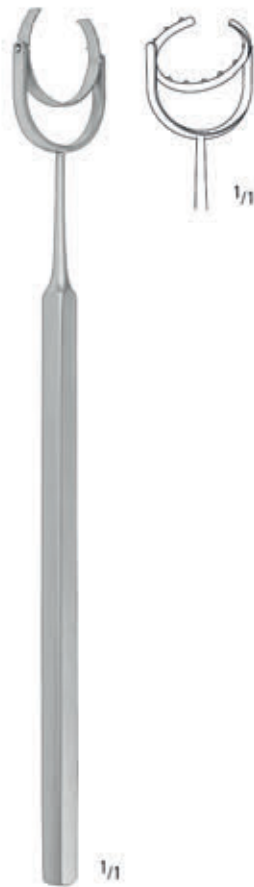

**THORNTON**  
KP 550/12  
12,0 cm/4<sup>3</sup>/<sub>4</sub>"  
Ø 13 mm



**SAUTER**  
KP 731/27  
3,5 cm/1<sup>1</sup>/<sub>2</sub>"  
27G



L(mm)	B(mm)	H(mm)	
255	245	50	SK 105/05

Contents:		Qty
AA 060/03	DIEFFENBACH BULLDOG CLAMPS STR 3,5 CM	2
AA 114/10	HARTMANN FORCEPS STR 10,0 CM	2
AA 150/12	HALSTED-MOSQUITO FCPS STR 12,5 CM	2
AA 711/09	JONES TOWEL FORCEPS 9,0 CM	2
AA 751/13	BACKHAUS TOWEL FORCEPS 13,0 CM	2
AB 710/10	GRAEFE IRIS FORCEPS STR SERR. 10,0 CM	1
AB 750/07	BARRAQUER-KATZIN FIX.FCPS 1X2 T. 7,0 CM	1
AB 816/01	CASTROVIEJO SUTURE FORCEPS 10,0 CM	2
AB 824/02	BONACCOLTO SUTURE FORCEPS 10,0 CM FINE	1
AB 825/02	BONN SUTURE FORCEPS 10,0 CM ULRTA FINE	2
AB 848/11	FAULKNER LENS HOLDING FORCEPS 11,0 CM	1
AC 466/10	IRIS SCISSORS STR W LARGE BOWS 10,0 CM	1
AC 467/10	IRIS SCISSORS CVD W LARGE BOWS 10,0 CM	1
AC 474/11	STEVENS TENOTOM.SCS.STR POINTED 11,5 CM	1
AC 776/01	VANNAS MOD.TÜBINGEN STRAIGHT 8,5 CM	1
AC 780/11	WESTCOTT TENOTOMY SCS.POINTED 11,0 CM	1
AE 657/14	CASTROVIEJO NH CVD SMOOTH 14,0 CM	1
AE 660/14	CASTROVIEJO NH STR RA SMOOTH 14,0 CM	1
AR 282/20	CASTROVIEJO CIRCLE 8,0 CM STRAIGHT	1
KP 002/12	JAMESON MUSCLE HOOK 12,0 CM	2
KP 010/14	GASS RETINAL DETACHMENT HOOK 14,0 CM	2
KP 211/08	LIEBERMAN EYE SPECULA 15 MM 8,0 CM ASP.	1
KP 261/15	SAUTTER ORBITAL SPATUL MEDIUM 15,0 CM	1
KP 262/13	ARRUGA PROTECTOR 13,0 CM	1
KP 354/12	FOREIGN BODY NEEDLE STRAIGHT 12,0 CM	1
KP 390/00	VITRECTOMY SCISSORS STRAIGHT SMOOTH 0°	1
KP 394/00	VITRECTOMY GRASPING FCPS STRAIGHT SMOOTH	1
KP 700/00	BISHOP-HARMON ANTERIOR CHAMBER	1
KP 760/21	INJECTION CANNULA 21G 4,5 CM	1
SK 305/05	WIRE BASKET, 485 X 255 X 50 MM	1

Sterilization Container KYE 200/61, if required



**DIEFFENBACH**  
AA 060/03  
3,5 cm/1 1/2"

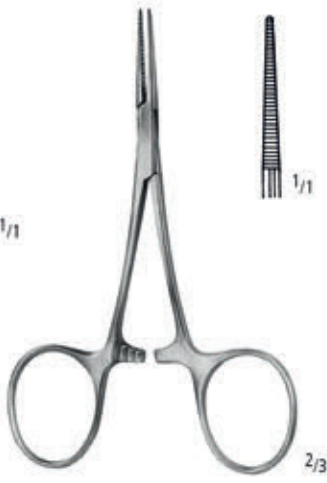

**HARTMANN**  
AA 114/10  
10,0 cm/4"



**HALSTED-MOSQUITO**  
AA 150/12  
12,5 cm/5"



**JONES**  
AA 711/09  
9,0 cm/3 1/2"

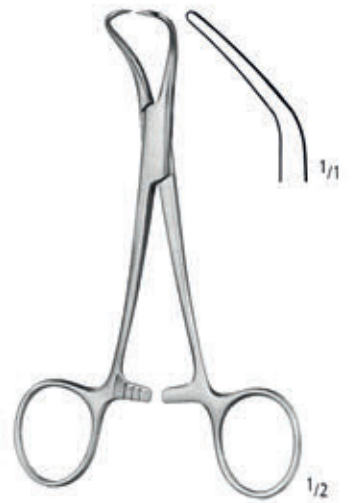

**BACKHAUS**  
AA 751/13  
13,0 cm/5"

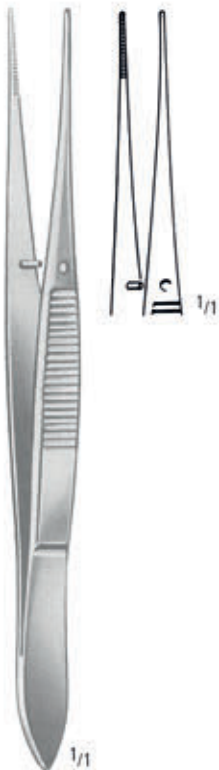

**GRAEFE**  
AB 710/10  
10,0 cm/4"



**BARRAQUER-KATZIN 1:2 (Colibri)**  
AB 750/07  
7,0 cm/2 3/4"



**CASTROVIEJO 1:2**  
AB 816/01  
0,12 mm  
10,0 cm/4"



**BONACCOLTO**  
AB 824/02  
10,0 cm/4"



**MOD. BONN**  
AB 825/02  
10,0 cm/4"



**FAULKNER**  
AB 848/11  
11,0 cm/4 1/3"

ZS 160/85

VITREKTOMIE (PARS PLANA)  
VITRECTOMIE (PARS PLANA)

VITRECTOMY (PARS PLANA)  
VITRECTOMIA PARS-PLANA

VITRECTOMIA PARS-PLANA

mit großen Ringen  
with large bows  
con anillos grandes  
avec grands anneaux  
con anelli grandi

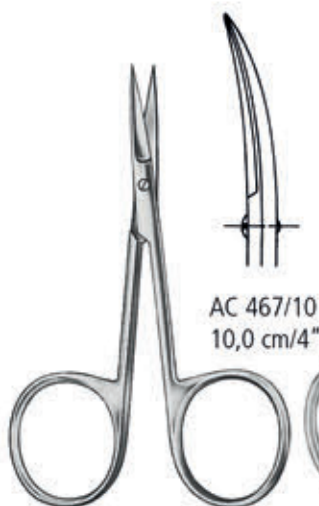

AC 466/10  
10,0 cm/4"

spitz  
pointed  
agudas  
pointues  
acuta

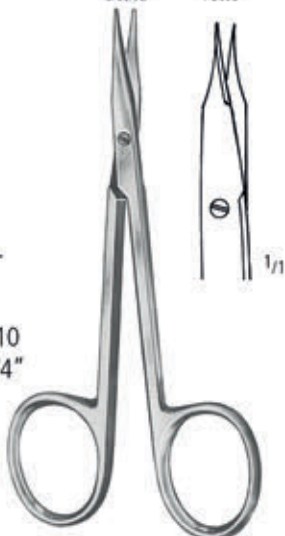

STEVENS  
AC 474/11  
11,5 cm/4 1/2"

gerade  
straight  
rectas  
droits  
rette



VANNAS MOD.  
TÜBINGEN  
AC 776/01  
8,5 cm/3 1/3"



WESTCOTT  
AC 780/11  
11,0 cm/4 1/3"



CASTROVIEJO  
AE 657/14  
14,0 cm/5 1/2"



CASTROVIEJO  
AE 660/14  
14,0 cm/5 1/2"

Messbereich 20 mm  
measuring range 20 mm  
campo de medición 20 mm  
étendue de mesurage 20 mm  
ampiezza di misura 20 mm



CASTROVIEJO  
AR 282/20  
8,0 cm/ 3"



JAMESON  
KP 002/12  
12,0 cm/4 3/4"



GASS  
KP 010/14  
14,0 cm/5 1/2"

B



LIEBERMAN  
KP 211/08  
8,0 cm/3 1/4"  
B = 15 mm

ZS 160/85

VITREKTOMIE (PARS PLANA)  
VITRECTOMIE (PARS PLANA)

VITRECTOMY (PARS PLANA)  
VITRECTOMIA PARS-PLANA

VITRECTOMÍA PARS-PLANA



**SAUTER**  
KP 261/15  
15,0 cm/6"



**ARRUGA**  
KP 262/13  
13,0 cm/5"



KP 354/12  
12,0 cm/ 4<sup>3</sup>/<sub>4</sub>"



**BISHOP-HARMON**  
KP 700/00

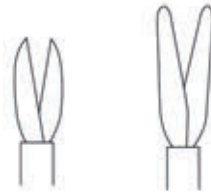

KP 390/00  
0°      KP 394/00

ohne Spülung  
without irrigation  
sin irrigaciòn  
sans irrigation  
senza irrigazione



Set komplett  
Set complete  
Juego completo  
Jeu complet  
Set completo

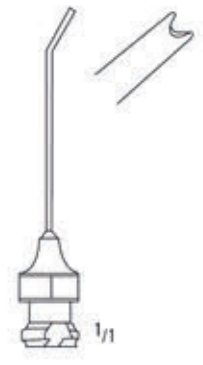

KP 760/21  
4,5 cm/2"  
21G

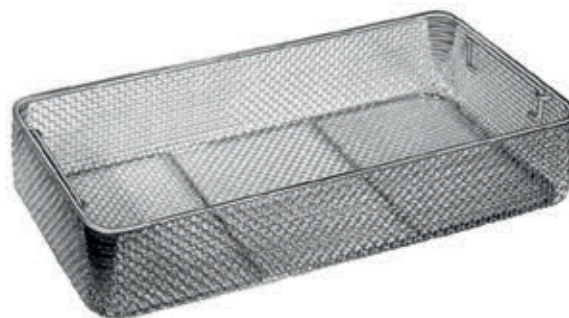

L(mm)	B(mm)	H(mm)	
485	255	50	SK 305/05



KLEMMEN  
HEMOSTATS  
PINZAS HEMOSTATICAS  
PINCES HEMOSTATIQUES  
PINZE EMOSTATICHE

AA

nopa<sup>®</sup> instruments

Weitere Klemmen finden Sie in unserem Katalog „Allgemeines Instrumentarium“ in Gruppe AA.

For further hemostats kindly refer to our catalogue „General Instruments“, section AA.

Para pinzas hemostaticas adicionales, por favor consulte nuestro catálogo de „Instrumental de uso general“, grupo AA.

Pour des pinces hemostatiques supplémentaires, consultez notre catalogue „Instrumentation Generale“, section AA.

Per gli altri pinze emostatiche, consultare il nostro catalogo „Strumentazione Generale“, gruppo AA.





Bulldogklemmen, Anlegezangen  
 Bulldog Clamps, Setting Forceps  
 Clamps Bulldog, Pinza para poner  
 Clamps Bulldog, Pince à poser  
 Pinze Bulldog, Pinza per posizionare

AA

AB

AC

AD

AE

AK

AR

KA

KM

KO

KP

XR



**DIEFFENBACH**

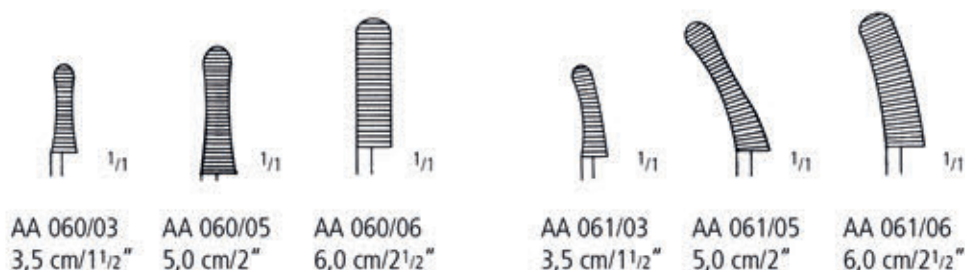

AA 060/03 3,5 cm/1 1/2"    AA 060/05 5,0 cm/2"    AA 060/06 6,0 cm/2 1/2"  
 AA 061/03 3,5 cm/1 1/2"    AA 061/05 5,0 cm/2"    AA 061/06 6,0 cm/2 1/2"



**JOHNS-HOPKINS**  
 AA 069/24  
 24,5 cm/9 3/4"



**JOHNS-HOPKINS**

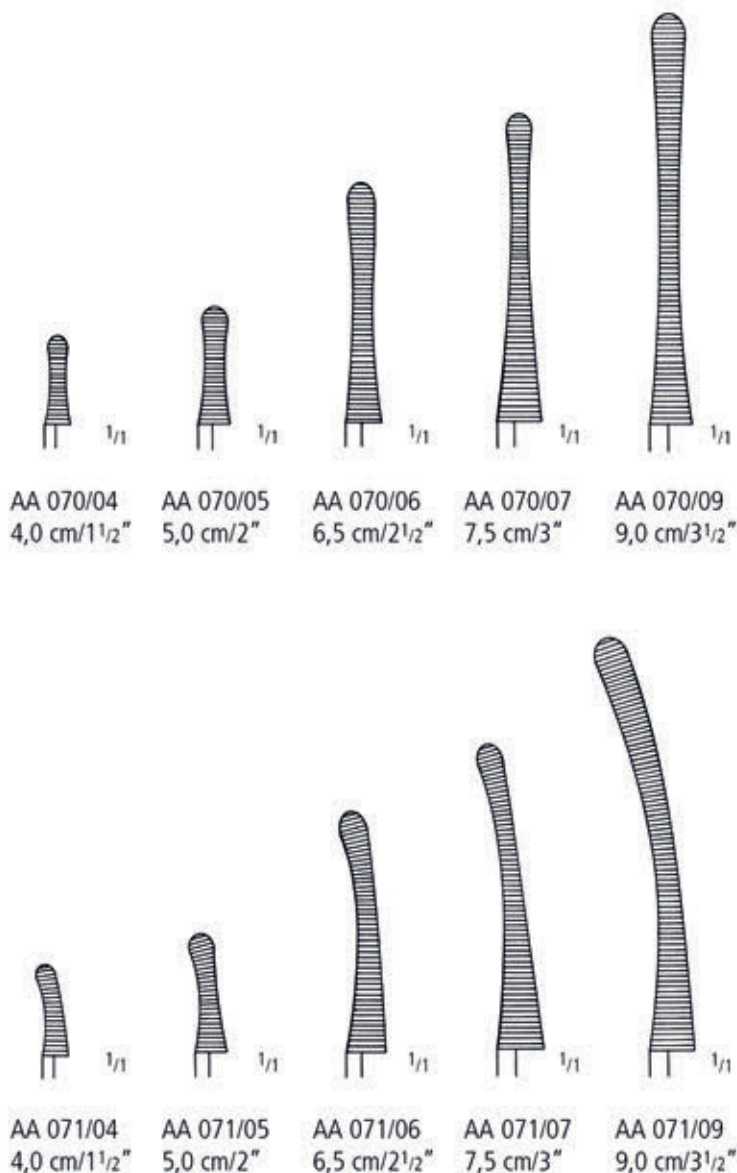

AA 070/04 4,0 cm/1 1/2"    AA 070/05 5,0 cm/2"    AA 070/06 6,5 cm/2 1/2"    AA 070/07 7,5 cm/3"    AA 070/09 9,0 cm/3 1/2"  
 AA 071/04 4,0 cm/1 1/2"    AA 071/05 5,0 cm/2"    AA 071/06 6,5 cm/2 1/2"    AA 071/07 7,5 cm/3"    AA 071/09 9,0 cm/3 1/2"

Arterienklemmen  
 Artery Forceps  
 Pinzas hemostáticas  
 Pincas hémostatiques  
 Pinze emostatiche

# T = TITAN



**HARTMANN**  
 AA 114/10  
 AA 114/10 T  
 10,0 cm/4"



**HARTMANN**  
 AA 115/10  
 AA 115/10 T  
 10,0 cm/4"

**WILLIAM STEWART HALSTED**  
 was professor of surgery in the Johns Hopkins University.  
 In 1890 he had bronze casts made of his own hands. On these casts the first surgical rubber gloves were moulded.



**HALSTED-MOSQUITO**  
 AA 150/12      AA 151/12  
 AA 150/12 T    AA 151/12 T  
 AA 150/14      AA 151/14

12,5 cm/5"  
 12,5 cm/5"  
 14,0 cm/5½"

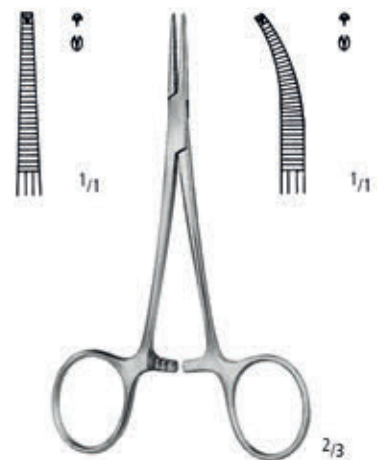

**HALSTED-MOSQUITO 1:2**  
 AA 152/12      AA 153/12  
 AA 152/12 T    AA 153/12 T  
 AA 152/14      AA 153/14

Tuchklemmen  
Towel Forceps  
Pinzas para compresas, Pinzas de campo  
Pincas à champs, Pincas à compresses  
Pinze per fissare le compresse (Fissarele)

AA

AB

AC

AD

AE

AK

AR

KA

KM

KO

KP

XR



**SCHAEDEL**  
AA 710/09  
9,0 cm/3 1/2"



**JONES**  
5,0 cm/2"  
9,0 cm/3 1/2"  
AA 711/05  
AA 711/09



AA 749/11  
11,0 cm/4 1/2"

mit Schlauch- oder Kabelhalter  
with clip for tubing or cable  
con porta-tubo o porta-cable  
avec clamp porte-tube ou porte-  
-corton d'alimentation  
con porta tubo o porta cavo



**BACKHAUS**  
8,0 cm/3 1/4" AA 751/08  
11,0 cm/4 1/2" AA 751/11  
13,0 cm/5" AA 751/13  
15,0 cm/6" AA 751/15



**ROEDER**  
13,0 cm/5" AA 761/13  
15,0 cm/6" AA 761/15

Tuchklemmen  
Towel Forceps  
Pinzas para compresas, Pinzas de campo  
Pinces à champs, Pinces à compresses  
Pinze per fissare le compresse (Fissarele)



**LORNA**  
10,0 cm/4" AA 763/10  
13,0 cm/5" AA 763/13



**TOHOKU-JAPAN**  
10,0 cm/4" AA 764/10  
13,0 cm/5" AA 764/13

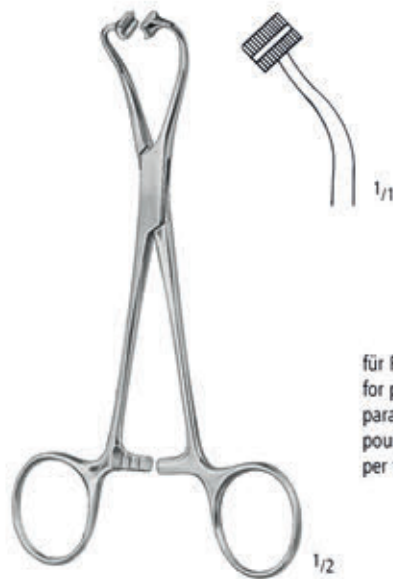

**PEERS**  
AA 765/14  
14,5 cm/5<sup>3</sup>/<sub>4</sub>"

für Papiertücher  
for paper tissues  
para servilletas de papel  
pour serviettes en papier  
per tessuti di carta

PINZETTEN  
FORCEPS  
PINZAS  
PINCES  
PINZE

AB

nopa<sup>®</sup> instruments

Weitere Pinzetten finden Sie in unserem Katalog „Allgemeines Instrumentarium“ in Gruppe AB.

For further forceps kindly refer to our catalogue „General Instruments“, section AB.

Para pinzas adicionales, por favor consulte nuestro catálogo de „Instrumental de uso general“, grupo AB.

Pour des pinces supplémentaires, consultez notre catalogue „Instrumentation Generale“, section AB.

Per gli altri pinze, consultare il nostro catalogo „Strumentazione Generale“, gruppo AB.



Anatomische Pinzetten, Chirurgische Pinzetten  
 Dressing Forceps, Tissue Forceps  
 Pinzas de disección, Pinzas de disección con dientes  
 Pincers à dissection, Pincers a griffes  
 Pinze anatomiche per dissezione, Pinze chirurgiche a denti di topo

## T = TITAN



AB 100/12

1/2



AB 102/12

1/2



AB 110/12

1/2



AB 112/12

1/2

12,0 cm/4<sup>3</sup>/<sub>4</sub>"  
 12,0 cm/4<sup>3</sup>/<sub>4</sub>"  
 15,0 cm/6"

**ADSON**  
 AB 100/12  
 AB 100/12 T  
 AB 100/15

**MICRO-ADSON**  
 AB 102/12  
 AB 102/15

**ADSON 1:2**  
 AB 110/12  
 AB 110/12 T  
 AB 110/15

**MICRO-ADSON 1:2**  
 AB 112/12  
 AB 112/15



7 : 7  
 AB 116/07  
 AB 116/07 T

9 : 9  
 AB 116/09

**ADSON-BROWN**

12,0 cm/4<sup>3</sup>/<sub>4</sub>"



9 : 9

**ADSON-BROWN**

AB 117/09  
 12,0 cm/4<sup>3</sup>/<sub>4</sub>"



PINZETTEN FORCEPS PINZAS PINCES PINZE

Cilienpinzetten  
Cilia Forceps  
Pinzas de depilatorias  
Pincas à épiler les cils  
Pinze depilatorie



**LITTAUER**  
AB 620/08  
8,5 cm/3 1/2"



AB 621/09  
9,0 cm/3 1/2"



**DOUGLAS**  
AB 624/09  
9,0 cm/3 1/2"



**BEER**  
AB 626/09  
9,0 cm/3 1/2"



**ZIEGLER**  
AB 628/09  
9,0 cm/3 1/2"



**BARRAQUER**  
AB 633/10  
10,5 cm/4 1/4"



**GRADLE**  
AB 635/09  
9,5 cm/3 3/4"

AA

AB

AC

AD

AE

AK

AR

KA

KM

KO

KP

XR

**AB** PINZETTEN FORCEPS PINZAS PINCES PINZE

Irispinzetten  
Iris Forceps  
Pinzas para iris  
Pincès à iris  
Pinze per iride



AB 700/07

**GRAEFE**  
7,0 cm/2<sup>3</sup>/<sub>4</sub>"

- 0,5 mm AB 700/05
- 0,7 mm AB 700/07
- 1,0 mm AB 700/10



AB 701/07

**GRAEFE**  
7,0 cm/2<sup>3</sup>/<sub>4</sub>"

- AB 701/05
- AB 701/07
- AB 701/10



AB 702/07

**GRAEFE 1:2**  
7,0 cm/2<sup>3</sup>/<sub>4</sub>"

- AB 702/05
- AB 702/07
- AB 702/10



AB 703/07

**GRAEFE 1:2**  
7,0 cm/2<sup>3</sup>/<sub>4</sub>"

- AB 703/05
- AB 703/07
- AB 703/10



**GRAEFE**



7,0 cm/2<sup>3</sup>/<sub>4</sub>" AB 710/07  
10,0 cm/4" AB 710/10



AB 711/07  
AB 711/10



AB 713/07  
AB 713/10



AB 714/07  
AB 714/10



AB 715/07  
AB 715/10

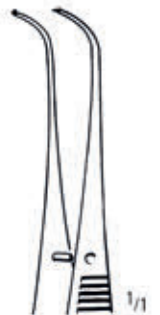

AB 717/07  
AB 717/10

PINZETTEN FORCEPS PINZAS PINCES PINZE

Irispinzetten  
Iris Forceps  
Pinzas para iris  
Pincès à iris  
Pinze per iride



**STEVENS 1:2**  
AB 718/01  
11,0 cm/4 1/2"



**STEVENS 1:2**  
AB 718/02  
11,0 cm/4 1/2"



**STEVENS**  
10,5 cm/4 1/2"



AB 720/01



AB 720/02



AB 720/03



AB 721/01 1:2



AB 721/02 1:2



AB 721/03 1:2



**FISCHER-ARLT 1:2**  
AB 723/07  
7,0 cm/2 3/4"

AA

AB

AC

AD

AE

AK

AR

KA

KM

KO

KP

XR

**AB** PINZETTEN FORCEPS PINZAS PINCES PINZE

Irispinzetten  
Iris Forceps  
Pinzas para iris  
Pincès à iris  
Pinze per iride



**FOERSTER**  
AB 726/08  
8,5 cm/3 1/2"



**FOERSTER**  
AB 727/08  
8,5 cm/3 1/2"



**FOERSTER 1:2**  
AB 728/08  
8,5 cm/3 1/2"



**FOERSTER 1:2**  
AB 729/08  
8,5 cm/3 1/2"



**HESS 1:2**  
AB 730/07  
7,0 cm/2 3/4"



**HESS 1:2**  
AB 731/09  
9,0 cm/3 1/2"



**MOD. BONN 1:2**  
AB 734/01  
7,0 cm/2 3/4"



**MOD. BONN 1:2**  
AB 734/02  
7,0 cm/2 3/4"

PINZETTEN FORCEPS PINZAS PINCES PINZE

Irispinzetten  
Iris Forceps  
Pinzas para iris  
Pincès à iris  
Pinze per iride

AA

AB

AC

AD

AE

AK

AR

KA

KM

KO

KP

XR



**MOD. BONN**  
7,0 cm/2<sup>3</sup>/<sub>4</sub>"

AB 735/01

AB 735/02



**BISHOP-HARMON**  
8,5 cm/3<sup>1</sup>/<sub>2</sub>"

AB 736/08

AB 738/08

1:2



**BISHOP-HARMON**  
8,5 cm/3<sup>1</sup>/<sub>2</sub>"

AB 740/08



AB 742/08

1:2



**KIRBY 1:2**  
AB 748/09  
9,0 cm/3<sup>1</sup>/<sub>2</sub>"



**BARRAQUER-KATZIN 1:2**  
**(Colibri)**  
AB 750/07  
7,0 cm/2<sup>3</sup>/<sub>4</sub>"

**AB** PINZETTEN FORCEPS PINZAS PINCES PINZE

Irispinzetten, Kapselpinzetten  
 Iris Forceps, Capsular Forceps  
 Pinzas para iris, Pinzas capsulares  
 Pincès à iris, Pincès capsulaires  
 Pinze per iride, Pinze capsulari



10 x

1/1

**TROUTMAN 1:2**  
**(Corneal)**  
 AB 751/07  
 7,5 cm/3"



10 x

1/1

**BARRAQUER-KATZIN 1:2**  
**(Colibri)**  
 AB 752/07  
 7,0 cm/2<sup>3</sup>/<sub>4</sub>"

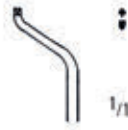

1/1

AB 756/07

Zähne seitwärts  
 teeth on side  
 dientes laterales  
 dents latérales  
 denti laterali



1/1

AB 757/07

Zähne unten  
 teeth below  
 dientes inferiores  
 dents en bas  
 denti in basso



1/1

**GILL-HESS 1:2**  
 7,5 cm/3"



10 x

0,3 mm

1/1

**GILL 1:2**  
 AB 762/07  
 7,5 cm/3"



1/1

**GILL-FUCHS**  
 AB 763/07  
 7,5 cm/3"



1/1

**TERSON**  
 AB 765/09  
 9,0 cm/3<sup>1</sup>/<sub>2</sub>"



1/1

**CASTROVIEJO**  
 AB 767/01  
 10,0 cm/4"



1/1

**CASTROVIEJO**  
 AB 767/02  
 10,0 cm/4"

PINZETTEN FORCEPS PINZAS PINCES PINZE

Kapselpinzetten, Fixierpinzetten  
 Capsular Forceps, Fixation Forceps  
 Pinzas capsulares, Pinzas de fijación  
 Pincas capsulaires, Pincas à fixer  
 Pinze capsulari, Pinze fissatrici

AA  
 AB  
 AC  
 AD  
 AE  
 AK  
 AR  
 KA  
 KM  
 KO  
 KP  
 XR

ungeeicht  
 not calibrated  
 no calibrada  
 non calibrée  
 non calibrata  
 AB 768/01



geeicht  
 calibrated  
 calibrada  
 calibrée  
 calibrata  
 AB 768/02

**ARRUGA**  
 10,0 cm/4"

ungeeicht  
 not calibrated  
 no calibrada  
 non calibrée  
 non calibrata  
 AB 769/01



geeicht  
 calibrated  
 calibrada  
 calibrée  
 calibrata  
 AB 769/02

**ARRUGA**  
 10,0 cm/4"

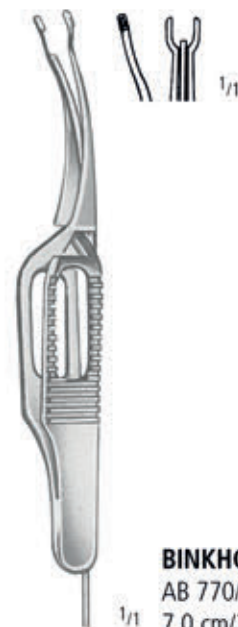

**BINKHORST**  
 AB 770/07  
 7,0 cm/2¾"



AB 785/01  
 ohne Schloss  
 without spring catch  
 sin cierre de resorte  
 sans arrêt à ressort  
 senza arresto a molla

AB 785/02  
 mit Schloss  
 with spring catch  
 con cierre de resorte  
 avec arrêt à ressort  
 con arresto a molla

**GRAEFE**  
 11,0 cm/4½"



AB 786/01  
 5 mm



AB 786/02  
 10 mm



**GREEN**  
 10,0 cm/4"

**AB** PINZETTEN FORCEPS PINZAS PINCES PINZE

Fixierpinzetten, Nahtpinzetten  
 Fixation Forceps, Suture Forceps  
 Pinzas de fijación, Pinzas para sutura  
 Pincès à fixer, Pincès pour sutures  
 Pinze fissatrici, Pinze per sutura



AB 790/09



AB 791/09

**CASTROVIEJO 1:1**  
 1/1 9,0 cm/3 1/2"



**ELSCHNIG 1:2**  
 AB 792/11  
 1/1 11,0 cm/4 1/2"

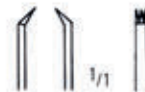

**ELSCHNIG 2:3**  
 AB 793/11  
 1/1 11,0 cm/4 1/2"

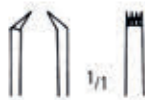

**ELSCHNIG 3:4**  
 AB 794/11  
 1/1 11,0 cm/4 1/2"



1:2  
 AB 796/02



2:3  
 AB 796/03

**LESTER**  
 1/1 9,0 cm/3 1/2"



**MOORFIELD**  
 AB 798/10  
 1/1 10,0 cm/4"



PINZETTEN FORCEPS PINZAS PINCES PINZE

Nahtpinzetten  
Suture Forceps  
Pinzas para sutura  
Pinces pour sutures  
Pinze per sutura

AA

AB

AC

AD

AE

AK

AR

KA

KM

KO

KP

XR

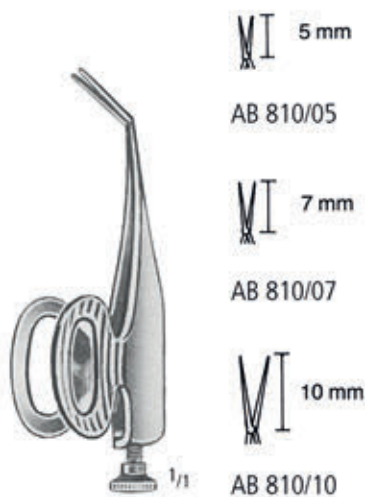

**BARRAQUER**  
5,5 cm/2<sup>1</sup>/<sub>4</sub>"



**ST. MARTIN 1:2**  
AB 812/07  
7,0 cm/2<sup>3</sup>/<sub>4</sub>"

Vorderkammer-Pinzetten  
Anterior Chamber Forceps  
Pinzas para la cámara anterior  
Pinces pour la chambre antérieure  
Pinze per la camera anteriore



0,12 mm  
0,30 mm  
0,50 mm  
1,00 mm  
1,50 mm

AB 816/01  
AB 816/03  
AB 816/05  
AB 816/10  
AB 816/15

**CASTROVIEJO 1:2**  
10,0 cm/4"



AB 817/01  
AB 817/03  
AB 817/05  
AB 817/10  
AB 817/15

**CASTROVIEJO 1:2**  
10,0 cm/4"



**McPHERSON**  
10,0 cm/4"

**AB** PINZETTEN FORCEPS PINZAS PINCES PINZE

Nahtpinzetten  
Suture Forceps  
Pinzas para sutura  
Pinces pour sutures  
Pinze per sutura



**KELMAN-McPHERSON 1:2**  
AB 820/10  
10,0 cm/4"



**BONACCOLTO**  
AB 824/01  
10,0 cm/4"



**BONACCOLTO**  
AB 824/02  
10,0 cm/4"

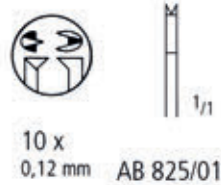

**MOD. BONN**  
10,0 cm/4"



**MOD. TÜBINGEN**  
AB 826/10  
10,0 cm/4"

PINZETTEN FORCEPS PINZAS PINCES PINZE

Nahtpinzetten, Fadenpinzetten  
 Suture Forceps, Suture Tying Forceps  
 Pinzas para sutura, Pinzas de ligadura  
 Pincas pour sutures, Pincas à ligature  
 Pinze per sutura, Pinze per ligature



**PAUFIQUE 1:2**  
 AB 828/10  
 10,0 cm/4"



**HARMS**  
 AB 829/01  
 10,0 cm/4"



**HARMS**  
 AB 829/02  
 10,0 cm/4"

AA

AB

AC

AD

AE

AK

AR

KA

KM

KO

KP

XR

**AB** PINZETTEN FORCEPS PINZAS PINCES PINZE

Muskelpinzetten  
Muscular Forceps  
Pinzas musculares  
Pincers musculaires  
Pinze muscolari

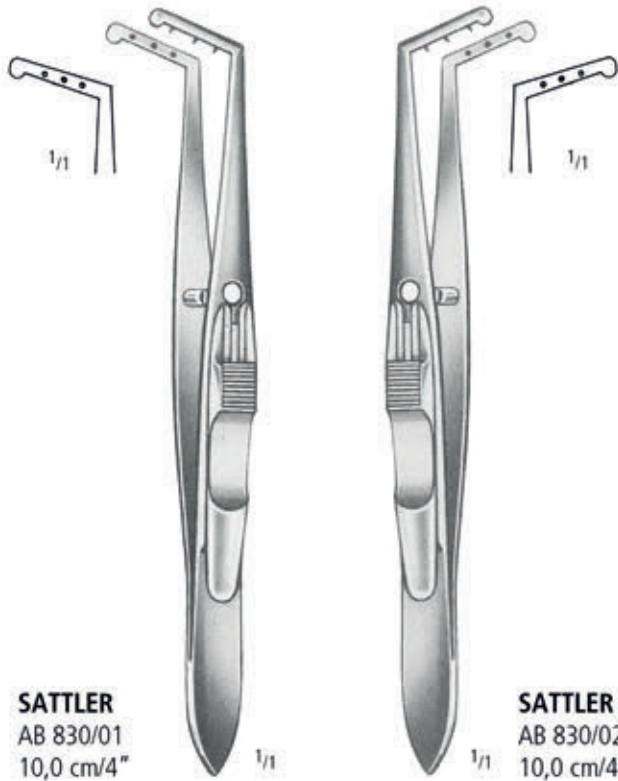

**SATTLER**  
AB 830/01  
10,0 cm/4"

**SATTLER**  
AB 830/02  
10,0 cm/4"

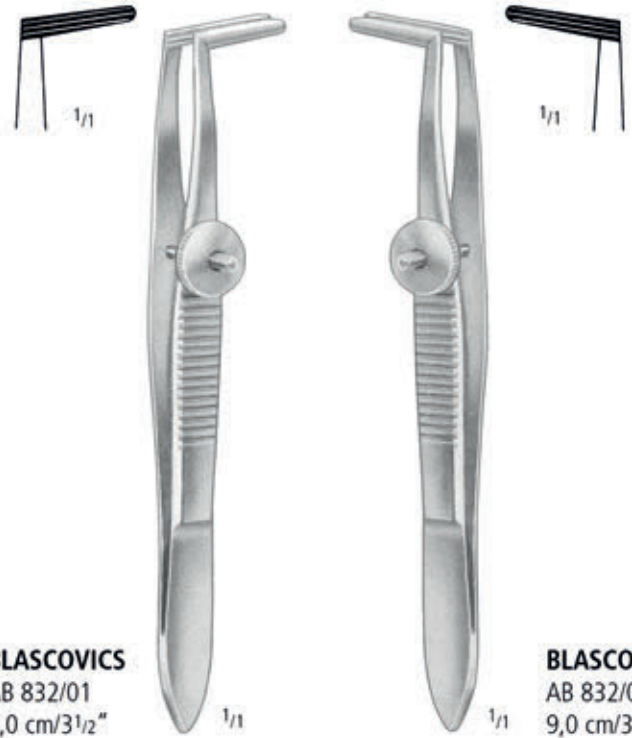

**BLASCOVICS**  
AB 832/01  
9,0 cm/3 1/2"

**BLASCOVICS**  
AB 832/02  
9,0 cm/3 1/2"

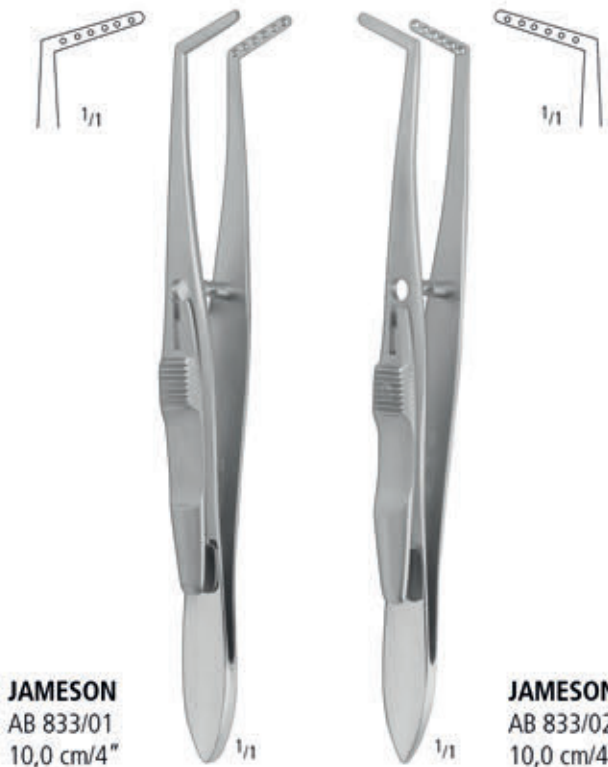

**JAMESON**  
AB 833/01  
10,0 cm/4"

**JAMESON**  
AB 833/02  
10,0 cm/4"

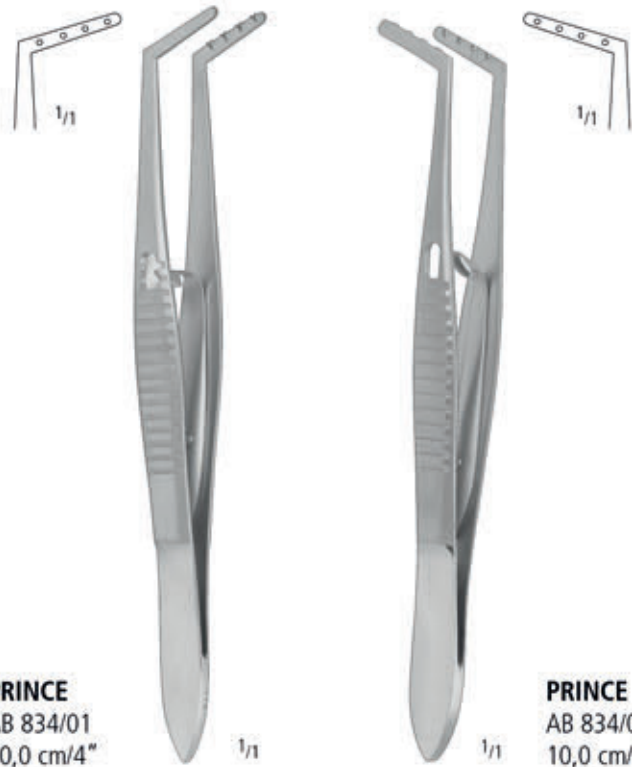

**PRINCE**  
AB 834/01  
10,0 cm/4"

**PRINCE**  
AB 834/02  
10,0 cm/4"

PINZETTEN FORCEPS PINZAS PINCES PINZE

Muskelpinzetten, Entropium- und Chalazionpinzetten  
 Muscular Forceps, Entropium and Chalazion Forceps  
 Pinzas musculares, Pinzas de entropión y de chalazión  
 Pincas musculaires, Pincas à entropion et à chalazion  
 Pinze muscolari, Pinze per palpebre (entropio) e per calazio



**BERENS**  
 AB 835/09  
 8,5 cm/3 1/2"



**ERHARDT**  
 AB 836/09  
 9,0 cm/3 1/2"



**SNELLEN**  
 AB 837/01  
 10,0 cm/4"



**SNELLEN**  
 AB 837/02  
 10,0 cm/4"



**AYER**  
 AB 838/01  
 9,0 cm/3 1/2"



**AYER**  
 AB 838/02  
 9,0 cm/3 1/2"



**DESMARRES**  
 9,0 cm/3 1/2"



AB 840/01

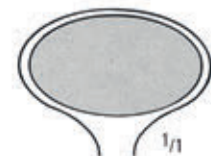

AB 840/02

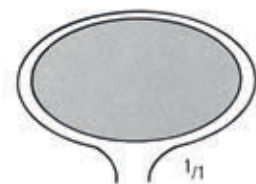

AB 840/03

AA

AB

AC

AD

AE

AK

AR

KA

KM

KO

KP

XR

**AB** PINZETTEN FORCEPS PINZAS PINCES PINZE

Chalazionpinzetten, Ptosispinzetten  
 Chalazion Forceps, Ptosis Forceps  
 Pinzas de chalazión, Pinzas para ptosis  
 Pincès à chalazion, Pincès à ptosis  
 Pinze per calazio, Pinze per ptosis



**LAMBERT**  
 AB 841/01  
 9,0 cm/3 1/2"

1/1



**LAMBERT**  
 AB 841/02  
 9,0 cm/3 1/2"

1/1



**BERKE**  
 AB 844/20  
 11,0 cm/4 1/2"  
 20 mm

1/1



**BERKE**  
 AB 844/27  
 11,0 cm/4 1/2"  
 27 mm

1/1

PINZETTEN FORCEPS PINZAS PINCES PINZE

Linsenhalte- und Kapsulorhexispinzetten  
 Lens Holding and Capsulorhexis Forceps  
 Pinzas para tener cristalino y capsulorhexis  
 Pincas à tenir de cristallins et capsulorhexis  
 Pinze per tenere il cristallino, Pinze capsulorhexis

AA

AB

AC

AD

AE

AK

AR

KA

KM

KO

KP

XR



**FAULKNER**  
 AB 848/11  
 11,0 cm/4 1/2"



**McDONALD**  
 AB 852/01  
 10,0 cm/4"



**McDONALD**  
 AB 852/02  
 10,0 cm/4"





SCHEREN  
SCISSORS  
TIJERAS  
CISEAUX  
FORBICI

AC

nopa<sup>®</sup> instruments

Weitere Scheren finden Sie in unserem Katalog „Allgemeines Instrumentarium“ in Gruppe AC.

For further scissors kindly refer to our catalogue „General Instruments“, section AC.

Para tijeras adicionales, por favor consulte nuestro catálogo de „Instrumental de uso general“, grupo AC.

Pour des ciseaux supplémentaires, consultez notre catalogue „Instrumentation Generale“, section AC.

Per gli altri forbici, consultare il nostro catalogo „Strumentazione Generale“, gruppo AC.





SCHEREN SCISSORS TIJERAS CISEAUX FORBICI

Feine Scheren, Augenscheren  
 Fine Scissors, Eye Scissors  
 Tijeras finas, Tijeras oculares  
 Ciseaux fins, Ciseaux oculaires  
 Forbici fini, Forbici oftalmologici

AA

AB

AC

AD

AE

AK

AR

KA

KM

KO

KP

XR



AC 430/08  
 8,0 cm/3 1/4"



AC 431/08  
 8,0 cm/3 1/4"

MOD. BONN



11,5 cm/4 1/2"

Fig. 1

gerade  
 straight  
 rectas  
 droits  
 rette



AC 446/01

Fig. 2



AC 446/02

Fig. 1

gebogen  
 curved  
 curvas  
 courbes  
 curve



AC 447/01

Fig. 2



AC 447/02

AC SCHEREN SCISSORS TIJERAS CISEAUX FORBICI

Augenscheren  
Eye Scissors  
Tijeras oculares  
Ciseaux oculaires  
Forbici oftalmologici



AC 448/11  
11,5 cm/4 1/2"



AC 449/11  
11,5 cm/4 1/2"

Irisscheren  
Iris Scissors  
Tijeras para iridectomia  
Ciseaux à iridectomie  
Forbici per iridectomia



9,0 cm/3 1/2"  
10,5 cm/4 1/4"  
11,5 cm/4 1/2"

AC 450/09  
AC 450/10  
AC 450/11



AC 451/09  
AC 451/10  
AC 451/11

SCHEREN SCISSORS TIJERAS CISEAUX FORBICI

Augenscheren  
Eye Scissors  
Tijeras oculares  
Ciseaux oculaires  
Forbici oftalmologici

AA

AB

AC

AD

AE

AK

AR

KA

KM

KO

KP

XR

Strabimusscheren  
Strabismus Scissors  
Tijeras para estrabismo  
Ciseaux à strabisme  
Forbici per strabismo



AC 460/11  
11,5 cm/4 1/2"



AC 461/11  
11,5 cm/4 1/2"

mit großen Ringen  
with large bows  
con anillos grandes  
avec grands anneaux  
con anelli grandi

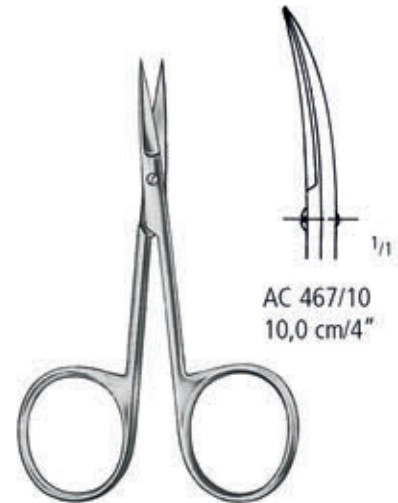

AC 467/10  
10,0 cm/4"

AC 466/10  
10,0 cm/4"



**GRAEFE**  
AC 469/10  
10,5 cm/4 1/4"

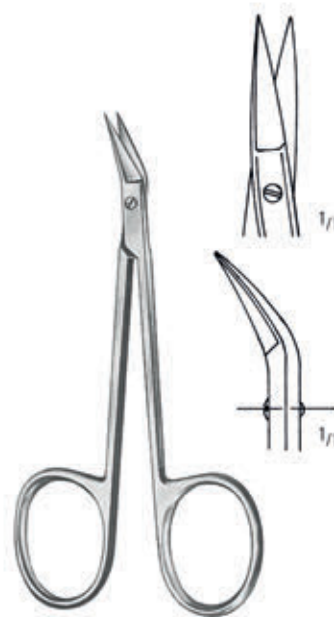

**WILMER**  
AC 471/10  
10,0 cm/4"

**AC** SCHEREN SCISSORS TIJERAS CISEAUX FORBICI

Augenscheren  
Eye Scissors  
Tijeras oculares  
Ciseaux oculaires  
Forbici oftalmologici



**LA GRANGE**  
AC 472/11  
11,5 cm/4<sup>1</sup>/<sub>2</sub>"



**CHADWICK**  
AC 473/11  
11,0 cm/4<sup>1</sup>/<sub>4</sub>"

Sehnenscheren  
Tenotomy Scissors  
Tijeras para tenotomía  
Ciseaux à ténatomie  
Forbici per tenotomia



**STEVENS**  
10,5 cm/4<sup>1</sup>/<sub>8</sub>"  
11,5 cm/4<sup>1</sup>/<sub>2</sub>"

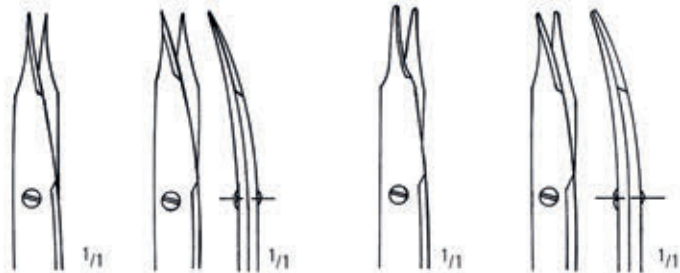

spitz  
agudas  
pointed  
pointues  
acuta

Original 11,5 cm

stumpf  
romas  
blunt  
mousses  
smussa

gerade  
straight  
rectas  
droits  
rette

gebogen  
curved  
curvas  
courbes  
curve

gerade  
straight  
rectas  
droits  
rette

gebogen  
curved  
curvas  
courbes  
curve

AC 474/10  
AC 474/11

AC 475/10  
AC 475/11

AC 476/10  
AC 476/11

AC 477/10  
AC 477/11

SCHEREN SCISSORS TIJERAS CISEAUX FORBICI

Augenscheren  
Eye Scissors  
Tijeras oculares  
Ciseaux oculaires  
Forbici oftalmologici

AA  
AB  
AC  
AD  
AE  
AK  
AR  
KA  
KM  
KO  
KP  
XR

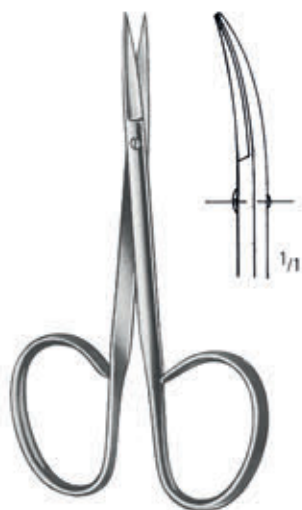

gerade  
straight  
rectas  
droits  
rette

gebogen  
curved  
curvas  
courbes  
curve

**RIBBON**  
10,0 cm/4"  
AC 488/10 AC 489/10



gerade  
straight  
rectas  
droits  
rette

gebogen  
curved  
curvas  
courbes  
curve

**RIBBON**  
10,0 cm/4"  
AC 490/10 AC 491/10



gerade  
straight  
rectas  
droits  
rette

gebogen  
curved  
curvas  
courbes  
curve

**RIBBON**  
10,0 cm/4"  
AC 492/10 AC 493/10

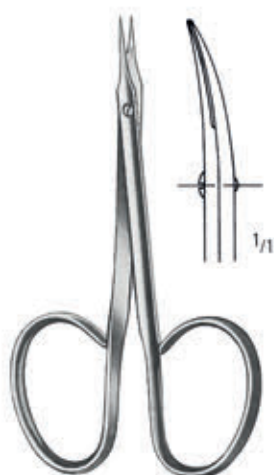

gerade  
straight  
rectas  
droits  
rette

gebogen  
curved  
curvas  
courbes  
curve

**RIBBON**  
9,5 cm/3<sup>3</sup>/<sub>4</sub>"  
AC 494/09 AC 495/09



gerade  
straight  
rectas  
droits  
rette

gebogen  
curved  
curvas  
courbes  
curve

**RIBBON**  
9,5 cm/3<sup>3</sup>/<sub>4</sub>"  
AC 496/09 AC 497/09

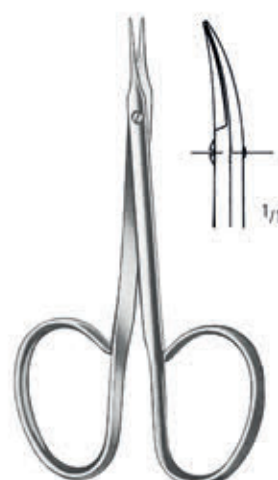

gerade  
straight  
rectas  
droits  
rette

gebogen  
curved  
curvas  
courbes  
curve

**RIBBON**  
9,5 cm/3<sup>3</sup>/<sub>4</sub>"  
AC 498/09 AC 499/09

**AC** SCHEREN SCISSORS TIJERAS CISEAUX FORBICI

Ligaturscheren, Iridektomiescheren  
 Ligature Scissors, Iris Scissors  
 Tijeras para ligaduras, Pinzas-tijeras para iridectomia  
 Ciseaux à ligatures, Ciseaux à iridectomie  
 Forbici per legatura, Forbici per iridectomia



**SPENCER**  
 9,5 cm/3<sup>1</sup>/<sub>2</sub>" AC 500/09  
 10,5 cm/4<sup>1</sup>/<sub>4</sub>" AC 500/10



Fig. 1



Fig. 2



Fig. 3

**NOYES**  
 12,0 cm/4<sup>3</sup>/<sub>4</sub>"



AC 751/12  
 AC 753/12  
 AC 755/12



**WECKER**  
 11,0 cm/4<sup>1</sup>/<sub>2</sub>"



AC 760/11



AC 762/11



AC 764/11

Fig.1 AC 750/12  
 Fig.2 AC 752/12  
 Fig.3 AC 754/12



SCHEREN SCISSORS TIJERAS CISEAUX FORBICI

Iridektomiescheren  
 Iris Scissors  
 Pinzas-tijeras para iridectomía  
 Ciseaux à iridectomie  
 Forbici per iridectomia

AA

AB

AC

AD

AE

AK

AR

KA

KM

KO

KP

XR



**BARRAQUER**  
 5,5 cm/2<sup>1</sup>/<sub>4</sub>"

- 5 mm AC 768/05
- 7 mm AC 768/07
- 10 mm AC 768/10



**CASTROVIEJO**  
 AC 770/00  
 9,0 cm/3<sup>1</sup>/<sub>2</sub>"



AC 770/02



AC 770/03



AC 771/09



AC 772/09

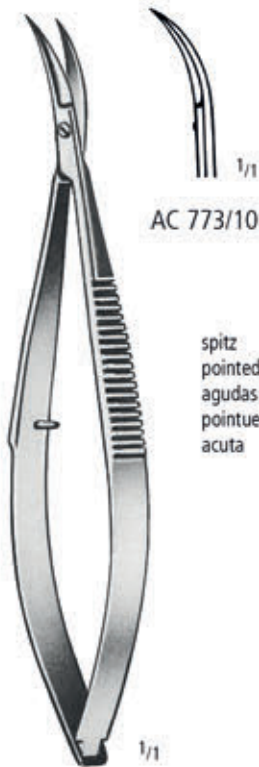

AC 773/10

spitz  
 pointed  
 agudas  
 pointues  
 acuta

**CASTROVIEJO**  
 10,0 cm/4"

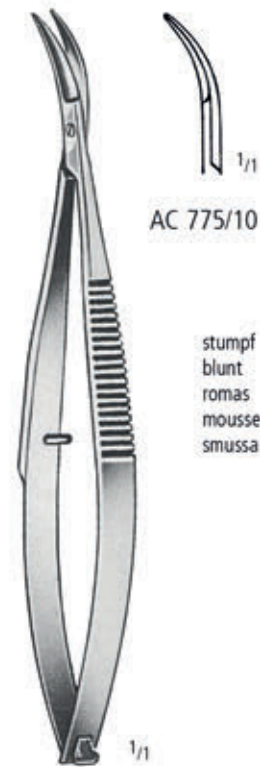

AC 775/10

stumpf  
 blunt  
 romas  
 mousses  
 smussa

**CASTROVIEJO**  
 10,0 cm/4"

**AC** SCHEREN SCISSORS TIJERAS CISEAUX FORBICI

Nachstarscheren  
 Secondary Cataract Scissors  
 Pinzas-tijeras para catarata secundaria  
 Pincis ciseaux pour le cataracte secondaire  
 Pinze-forbici per cataratta secundaria



gerade  
 straight  
 rectas  
 droiti  
 rette

1/1

AC 776/01  
 8,5 cm/3 1/2"



gebogen  
 curved  
 curvas  
 courbes  
 curve

1/1

AC 776/02  
 8,5 cm/3 1/2"

**VANNAS MOD. TÜBINGEN**



kniegebogen  
 angular  
 acodadas  
 coudés  
 angolato

1/1

AC 776/03  
 8,5 cm/3 1/2"



aufgewinkelt  
 angled on flat  
 acodadas hacia arriba  
 coudés vers le haut  
 angolato in alto

1/1

AC 776/04  
 8,5 cm/3 1/2"



gerade  
 straight  
 rectas  
 droiti  
 rette

1/1

**VANNAS**  
 AC 778/01  
 8,0 cm/3 1/4"



gebogen  
 curved  
 curvas  
 courbes  
 curve

1/1

**VANNAS**  
 AC 778/02  
 8,0 cm/3 1/4"



kniegebogen  
 angular  
 acodadas  
 coudés  
 angolato

1/1

**VANNAS**  
 AC 778/03  
 8,0 cm/3 1/4"



aufgewinkelt  
 angled on flat  
 acodadas hacia arriba  
 coudés vers le haut  
 angolato in alto

1/1

**VANNAS**  
 AC 778/04  
 8,0 cm/3 1/4"

SCHEREN SCISSORS TIJERAS CISEAUX FORBICI

Nachstarscheren, Sehnenscheren, Hornhautscheren  
 Secondary Cataract Scissors, Tenotomy Scissors, Corneal Scissors  
 Pinzas-tijeras para catarata secundaria, Pinzas-tijeras para tenotomía y córnea  
 Pincés ciseaux pour le cataracte secondaire, Ciseaux à ténatomie, Ciseaux corneales  
 Pinze-forbici per cataratta secondaria, Forbici per tenotomia e per cornea

AA

AB

AC

AD

AE

AK

AR

KA

KM

KO

KP

XR



**GILLS-WELSH**  
8,5 cm/3 1/2"



kniegebogen  
angular  
acodadas  
coudés  
angolato



aufgewinkelt  
angled on flat  
acodadas hacia arriba  
coudés vers le haut  
angolato in alto



**WESTCOTT**  
AC 780/11  
11,0 cm/4 1/2"



**WESTCOTT**  
AC 782/11  
11,0 cm/4 1/2"



**CASTROVIEJO**  
AC 785/01  
10,0 cm/4"



**CASTROVIEJO**  
AC 785/02  
10,0 cm/4"

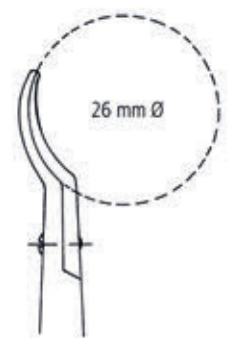

**AC** SCHEREN SCISSORS TIJERAS CISEAUX FORBICI

Hornhautscheren  
 Corneal Scissors  
 Pinzas-tijeras para córnea  
 Ciseaux corneales  
 Forbici per cornea



**CASTROVIEJO**  
 AC 786/01  
 11,0 cm/4 1/2"



**CASTROVIEJO**  
 AC 786/02  
 11,0 cm/4 1/2"



**TROUTMAN**  
 AC 788/01  
 10,0 cm/4"



**TROUTMAN**  
 AC 788/02  
 10,0 cm/4"



**KATZIN**  
 AC 790/01  
 10,0 cm/4"



**KATZIN**  
 AC 790/02  
 10,0 cm/4"



**KATZIN**  
 AC 791/01  
 11,0 cm/4 1/2"

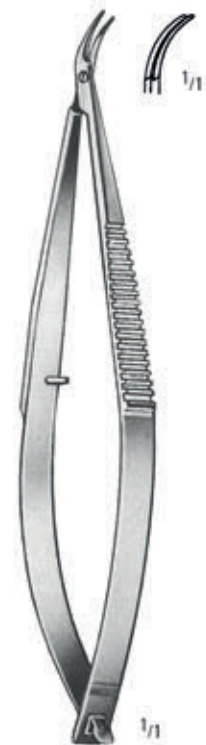

**KATZIN**  
 AC 791/02  
 11,0 cm/4 1/2"

SCHEREN SCISSORS TIJERAS CISEAUX FORBICI

Hornhautscheren  
 Corneal Scissors  
 Pinzas-tijeras para córnea  
 Ciseaux corneales  
 Forbici per cornea

AA

AB

AC

AD

AE

AK

AR

KA

KM

KO

KP

XR



**KATZIN-BARRAQUER**

AC 792/01  
 10,0 cm/4"



AC 792/02  
 10,0 cm/4"



AC 793/00  
 10,0 cm/4"



AC 793/01  
 10,0 cm/4"

Hornhautscheren, Mikroscheren  
 Corneal Section Scissors, Micro Scissors  
 Pinzas-tijeras para córnea, Micro Tijeras  
 Pincas ciseaux corneales, Micro-ciseaux  
 Forbici per cornea, Micro forbici



AC 794/12  
 12,0 cm/4<sup>3</sup>/<sub>4</sub>"



**NOYES**  
 AC 795/15  
 15,0 cm/6"



**WESTCOTT**  
 AC 797/01  
 11,5 cm/4<sup>1</sup>/<sub>2</sub>"



**WESTCOTT**  
 AC 797/02  
 11,5 cm/4<sup>1</sup>/<sub>2</sub>"

SCHEREN SCISSORS TIJERAS CISEAUX FORBICI

Mikroscheren  
Micro Scissors  
Micro Tijeras  
Micro Ciseaux  
Micro Forbici

- >> Alle unsere Mikroscheren werden von Fachkräften mit jahrelanger Erfahrung hergestellt. Die Endkontrolle findet unter dem Mikroskop statt. Um Ihnen ein ermüdungsfreies Arbeiten zu ermöglichen, wird dem Federdruck größte Aufmerksamkeit gewidmet.
- >> Bitte wählen Sie unter Rund- oder Flachgriffscheren.

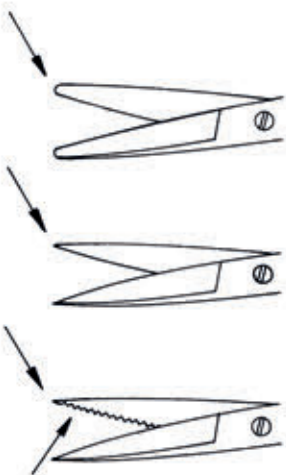

**Dissection:** Gebogene Blätter, abgerundete Spitzen ermöglichen eine gute und sichere Dissektion, ohne Nerven und Blutgefäße zu beschädigen.

**Adventitia:** Gerade Blätter, sehr scharfe Spitzen gewährleisten präzises Anfrischen von Gefäßenden.

**Nerve:** Ein Blatt ist fein gezahnt, um ein Herausgleiten des Nervs zu vermeiden.

- >> All our Micro Scissors are manufactured by skilled craftsmen with many years of experience. Final inspection is carried out under a microscope. Careful attention is paid to the closing pressure of the spring handle, to ensure precise work during surgeries, without fatigue.
- >> Round or flat handle scissors according to your preference.

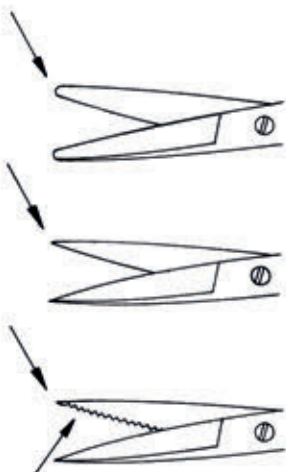

**Dissection:** Curved blades, slightly rounded tips ensure safe dissection without damage to nerves and vessels.

**Adventitia:** Straight blades, very sharp tips for finest trimming of vessel ends.

**Nerve:** One blade is fine-toothed to avoid slipping of the nerve.

AA

AB

AC

AD

AE

AK

AR

KA

KM

KO

KP

XR

Mikroscheren  
Micro Scissors  
Micro Tijeras  
Micro Ciseaux  
Micro Forbici



14,5 cm/5<sup>3</sup>/<sub>4</sub>"



**Dissection**  
AC 801/15

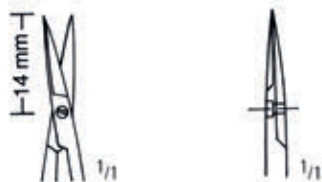

**Adventitia**  
AC 803/15



18,0 cm/7"



**Dissection**  
AC 801/18

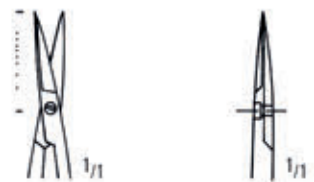

**Adventitia**  
AC 803/18



SCHEREN SCISSORS TIJERAS CISEAUX FORBICI

Mikroscheren  
Micro Scissors  
Micro Tijeras  
Micro Ciseaux  
Micro Forbici

AA

AB

AC

AD

AE

AK

AR

KA

KM

KO

KP

XR

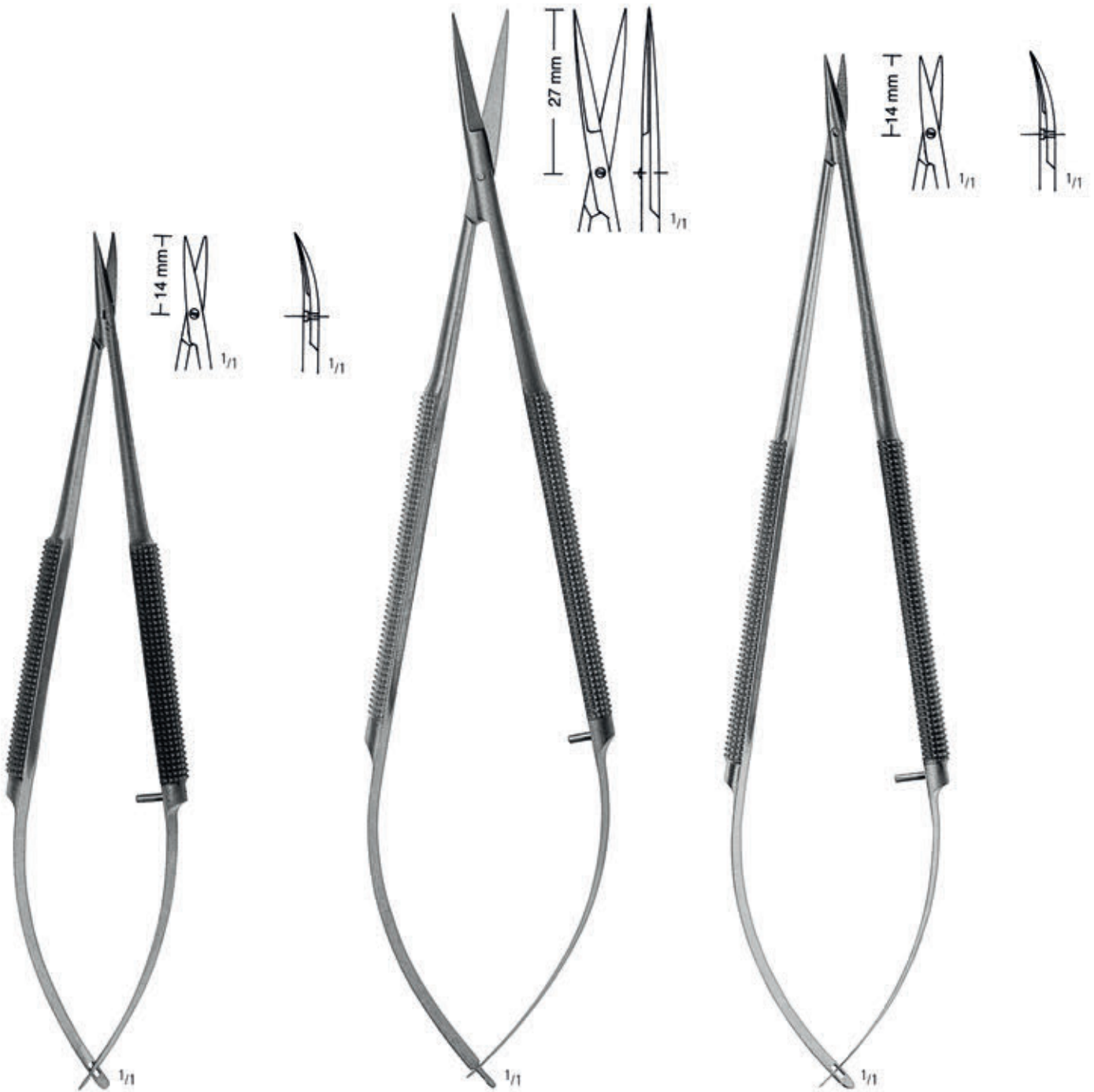

AC 807/14  
14,5 cm/5<sup>3</sup>/<sub>4</sub>"

AC 812/18  
18,0 cm/7"

AC 817/18  
18,0 cm/7"

**AC** SCHEREN SCISSORS TIJERAS CISEAUX FORBICI

Mikroscheren  
Micro Scissors  
Micro Tijeras  
Micro Ciseaux  
Micro Forbici



11,0 cm/4 1/8"

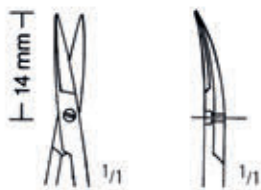

**Dissection**  
AC 821/11

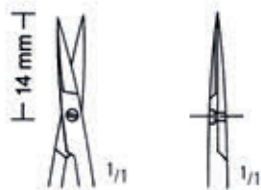

**Adventitia**  
AC 830/11



15,0 cm/6"

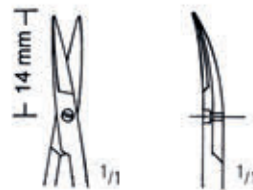

**Dissection**  
AC 823/15

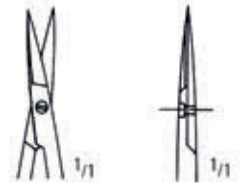

**Adventitia**  
AC 832/15

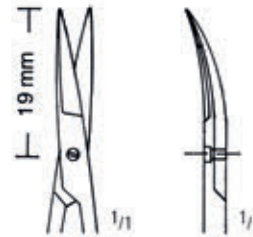

**Dissection**  
AC 825/15

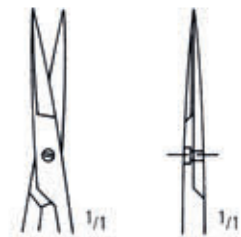

**Adventitia**  
AC 834/15

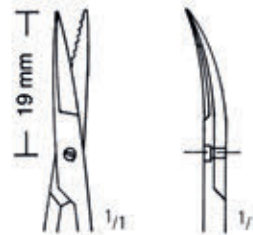

**Dissection**  
AC 827/15

>> Nerve >>

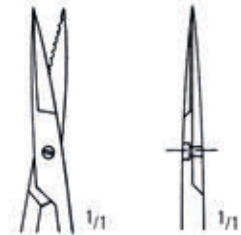

**Adventitia**  
AC 836/15

SCHEREN SCISSORS TIJERAS CISEAUX FORBICI

Mikroscheren  
Micro Scissors  
Micro Tijeras  
Micro Ciseaux  
Micro Forbici

AA

AB

AC

AD

AE

AK

AR

KA

KM

KO

KP

XR



18,5 cm/7 1/3"



20 mm

AC 850/19



AC 851/19



16,0 cm/6 1/4"  
20,0 cm/8"  
22,5 cm/9"



AC 860/16  
AC 860/20  
AC 860/22



AC 861/16  
AC 861/20  
AC 861/22



AC 862/16  
AC 862/20  
AC 862/22



AC 863/16  
AC 863/20  
AC 863/22



AC 864/16  
AC 864/20  
AC 864/22



AC 865/16  
AC 865/20  
AC 865/22

Mikroscheren  
Micro Scissors  
Micro Tijeras  
Micro Ciseaux  
Micro Forbici

**T = TITAN**



18,0 cm/7"



AC 870/01  
AC 870/01 T  
25°



AC 870/02  
AC 870/02 T  
45°



AC 870/03  
AC 870/03 T  
60°



AC 870/04  
AC 870/04 T  
90°



AC 870/05  
AC 870/05 T  
125°



18,0 cm/7"



18,0 cm/7"



AC 871/01  
AC 871/01 T  
25°



AC 871/02  
AC 871/02 T  
45°



AC 871/03  
AC 871/0  
60°



AC 871/04  
AC 871/04 T  
90°



AC 871/05  
AC 871/05 T  
125°



18,0 cm/7"

SKALPELLE  
SCALPELS  
BISTURIES  
BISTOURIS  
BISTURI

AD

nopa<sup>®</sup> instruments

Weitere Skalpelle finden Sie in unserem Katalog „Allgemeines Instrumentarium“ in Gruppe AD.

For further scalpels kindly refer to our catalogue „General Instruments“, section AD.

Para bisturías adicionales, por favor consulte nuestro catálogo de „Instrumental de uso general“, grupo AD.

Pour des bistouris supplémentaires, consultez notre catalogue „Instrumentation Generale“, section AD.

Per gli altri bisturi, consultare il nostro catalogo „Strumentazione Generale“, gruppo AD.





SKALPELLE SCALPELS BISTURIES BISTOURIS BISTURI

Skalpellgriffe  
 Scalpel Handles  
 Mangos de bisturías  
 Manches pour bistouris  
 Manici per bisturi

AA  
 AB  
 AC  
**AD**  
 AE  
 AK  
 AR  
 KA  
 KM  
 KO  
 KP  
 XR



hohl  
 hollow  
 hueco  
 creux  
 vuoto

AD 009/03 No. 3      AD 010/03 No. 3      AD 020/13 No. 3L      AD 025/07 No. 7      AD 027/07 No. 7K      AD 030/16      **COLLIN** AD 040/08 No. 8

Skalpelli, Skalpellgriffe, Skalpellklingen  
 Scalpel Handles, Scalpel Blades  
 Mangos de bisturios, Hojas de bisturios  
 Manches pour bistouris, Lames de bistouris  
 Manici per bisturi, Lame per bisturi

# MINI

Verpackungseinheit 10 St.  
 packing unit 10 pcs.  
 unidad de venta 10 piezas  
 unité à 10 pièce  
 unità di vendita 10 pezzi

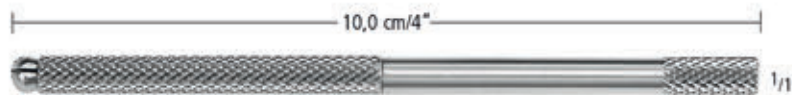

Fig. 65  
AD 065/65

steril  
 sterile  
 estériles  
 stériles  
 sterili



Fig. 67  
AD 065/67



AD 065/10

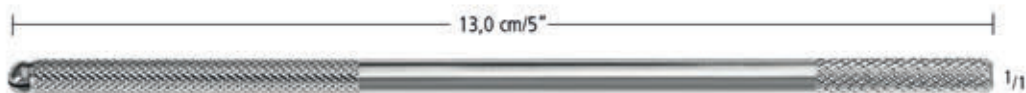

AD 065/13

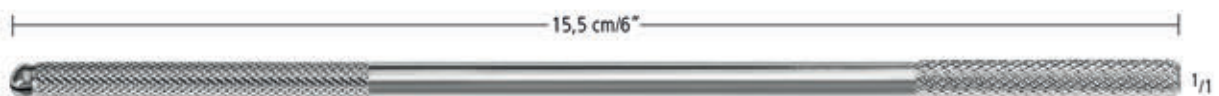

AD 065/15



SKALPELLE SCALPELS BISTURIES BISTOURIS BISTURI

Skalpellklingen  
Scalpel Blades  
Hojas de bisturías  
Lames pour bistouris  
Lame per bisturi

passend für die Griffe  
for handles  
para los mangos  
pour les manches  
per i manici

- AD 009/03
- AD 010/03
- AD 020/13
- AD 025/07
- AD 027/07
- AD 030/16
- AD 040/08



Fig.10  
AD 075/10



Fig.11  
AD 075/11



Fig.15  
AD 075/15



Fig.15c  
AD 076/15

steril  
sterile  
estériles  
stériles  
sterili



AA

AB

AC

AD

AE

AK

AR

KA

KM

KO

KP

XR

Rasierklingen, Klingenbrecher  
 Razor Blades, Blade Breakers  
 Hojas de afeitár, Pinzas para romper hojas  
 Lames de rasoir, Pincettes pour casser les lames  
 Lamette da barba, Pinze per rompere la lamette

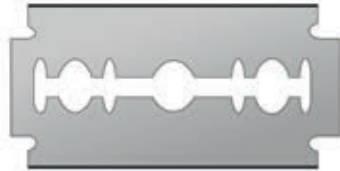

RASIERKLINGEN, VERPACKUNGSEINHEIT 10 STCK  
 RAZOR BLADES, PACKING UNIT 10 PIECES  
 HOJAS DE AFEITAR, UNIDAD DE VENTA 10 PZ  
 LAMES DE RASOIR, UNITÉ À 10 PIÈCES  
 LAMETTE DA BARBA, UNITÀ DI VENDITA 10 PZ

AD 540/00



**TROUTMAN-CHRIS**  
 AD 550/09  
 Ø 5,5 mm  
 9,0 cm/3 1/2"

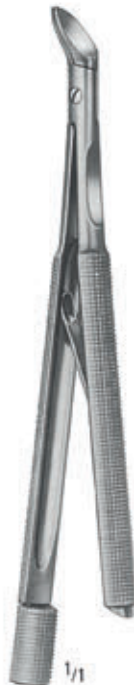

**TROUTMAN-CHRIS**  
 AD 551/09  
 Ø 5,5 mm  
 9,0 cm/3 1/2"



AD 552/11  
 11,0 cm/4 1/3"



**CASTROVIEJO**  
 AD 554/13  
 Ø 8 mm  
 13,0 cm/5"

NAHT  
SUTURE  
SUTURA  
SUTURE  
SUTURA

AE

nopa<sup>®</sup> instruments

Weitere Naht-Instrumente finden Sie in unserem Katalog „Allgemeines Instrumentarium“ in Gruppe AE.

For further suture instruments kindly refer to our catalogue „General Instruments“, section AE.

Para instrumentos de sutura adicionales, por favor consulte nuestro catálogo de „Instrumental de uso general“, grupo AE.

Pour des instruments de suture supplémentaires, consultez notre catalogue „Instrumentation Generale“, section AE.

Per gli altri accessori di sutura, consultare il nostro catalogo „Strumentazione Generale“, gruppo AE.



Nadelhalter, Nadelhalter mit Hartmetalleinsätzen  
 Needle Holders, Needle Holders with Tungsten Carbide Inserts  
 Porta-agujas, Porta-agujas con bocas de carburo de Tungsteno  
 Porte-aiguilles, Porte-aiguilles à mors en carbure de tungstène  
 Portaghi, Portaghi con placche di carburo di tungsteno



**DERF**  
 AE 050/12  
 12,5 cm/4<sup>3</sup>/<sub>4</sub>"



**HALSEY**  
 13,0 cm/5"

nopa<sup>®</sup>  
**TUC**



**RYDER/FRENCH-EYE**  
 AE 430/13  
 13,0 cm/5"



**DERF**  
 AE 450/12  
 12,5 cm/4<sup>3</sup>/<sub>4</sub>"

**T = TITAN**



AE 464/13



AE 466/13  
 AE 466/13 T

**HALSEY**  
 13,0 cm/5"

NAHT SUTURE SUTURA SUTURE SUTURA

Nadelhalter mit Hartmetalleinsätzen  
 Needle Holders with Tungsten Carbide Inserts  
 Porta-agujas con bocas de carburo de tungsteno  
 Porte-aiguilles à mors en carbure de tungstène  
 Portaghi con placche di carburo di tungsteno

T = TITAN



AE 570/14



AE 571/14



AE 572/14  
 AE 572/14 T



AE 573/14

**CASTROVIEJO**  
 14,0 cm/5 1/2"

**CASTROVIEJO**  
 14,0 cm/5 1/2"

nopa<sup>®</sup>  
**TUC**



AE 576/18



AE 577/18



AE 578/18



AE 579/18

18,0 cm/7"

18,0 cm/7"

AA  
 AB  
 AC  
 AD  
**AE**  
 AK  
 AR  
 KA  
 KM  
 KO  
 KP  
 XR

**AE** NAHT SUTURE SUTURA SUTURE SUTURA

Mikro-Nadelhalter mit Hartmetalleinsätzen  
 Micro-Needle Holders with Tungsten Carbide Inserts  
 Micro-porta-agujas con bocas de carburo de Tungsteno  
 Micro-porte-aiguilles à mors en carbure de tungstène  
 Micro-portaghi con placche di carburo di tungsteno



AE 580/01



AE 580/02  
 AE 580/02 T

**T = TITAN**

**JACOBSON**  
 21,0 cm/8<sup>1</sup>/<sub>4</sub>"

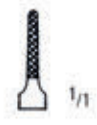

AE 582/16  
 16,0 cm/6<sup>1</sup>/<sub>4</sub>"



AE 582/18  
 18,0 cm/7"

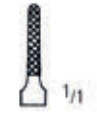

AE 582/20  
 20,0 cm/8"

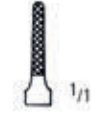

AE 582/23  
 23,0 cm/9"



AE 582/26  
 26,0 cm/10<sup>1</sup>/<sub>4</sub>"

**DIETHRICH**

nopa®  
**TUC**



**KALT**  
 AE 584/14  
 13,5 cm/5<sup>1</sup>/<sub>4</sub>"

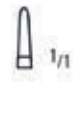

**CASTROVIEJO**  
 AE 586/13  
 13,0 cm/5<sup>1</sup>/<sub>4</sub>"



**POTTS-SMITH**  
 AE 588/22  
 22,0 cm/8<sup>3</sup>/<sub>4</sub>"

NAHT SUTURE SUTURA SUTURE SUTURA

Mikro-Nadelhalter mit Rundgriff  
 Micro-Needle-Holders with pen-type handle  
 Micro-porta-agujas con mango redondo  
 Micro-porte-aiguilles à manches rondes  
 Micro-portaghi con manici rotondi

AA  
 AB  
 AC  
 AD  
 AE  
 AK  
 AR  
 KA  
 KM  
 KO  
 KP  
 XR



**BARRAQUER-  
TROUTMAN**  
 AE 600/10  
 10,0 cm/4"



**BARRAQUER-  
TROUTMAN**  
 AE 601/10  
 10,0 cm/4"



**BARRAQUER-  
TROUTMAN**  
 AE 602/10  
 10,0 cm/4"



**BARRAQUER-  
TROUTMAN**  
 AE 603/10  
 10,0 cm/4"



**BARRAQUER**  
 AE 605/11  
 11,0 cm/4 1/4"



**BARRAQUER**  
 AE 605/13  
 13,0 cm/5"



**BARRAQUER**  
 AE 605/14  
 14,0 cm/5 1/2"



**BARRAQUER**  
 AE 606/14  
 14,0 cm/5 1/2"



**BARRAQUER**  
 AE 607/14  
 14,0 cm/5 1/2"

**AE** NAHT SUTURE SUTURA SUTURE SUTURA

Mikro-Nadelhalter mit Rundgriff  
 Micro-Needle-Holders with pen-type handle  
 Micro-porta-agujas con mango redondo  
 Micro-porte-aiguilles à manches rondes  
 Micro-portaghi con manici rotondi



**TROUTMAN**  
 AE 609/01  
 12,0 cm/4<sup>3</sup>/<sub>4</sub>"



**TROUTMAN**  
 AE 609/02  
 12,0 cm/4<sup>3</sup>/<sub>4</sub>"



**REILL**  
 AE 610/15

**REILL**  
 AE 611/15



**REILL**  
 AE 612/15

**REILL**  
 AE 613/15

**REILL**  
 15,0 cm/6"

**REILL**  
 15,0 cm/6"



NAHT SUTURE SUTURA SUTURE SUTURA

Mikro-Nadelhalter  
 Micro-Needle-Holders  
 Micro-porta-agujas  
 Micro-porte-aiguilles  
 Micro-portaghi

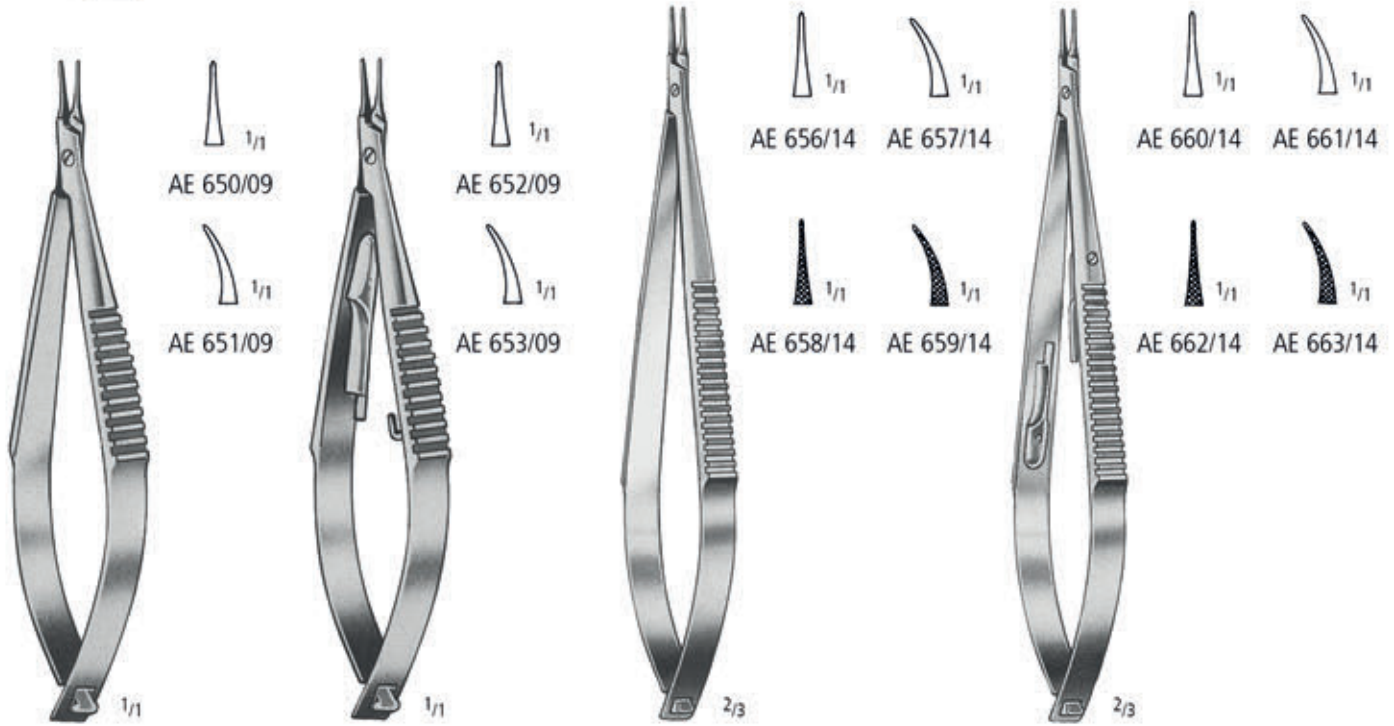

**CASTROVIEJO**  
 9,0 cm/3 1/2"

**CASTROVIEJO**  
 9,0 cm/3 1/2"

**CASTROVIEJO**  
 14,0 cm/5 1/2"

**CASTROVIEJO**  
 14,0 cm/5 1/2"

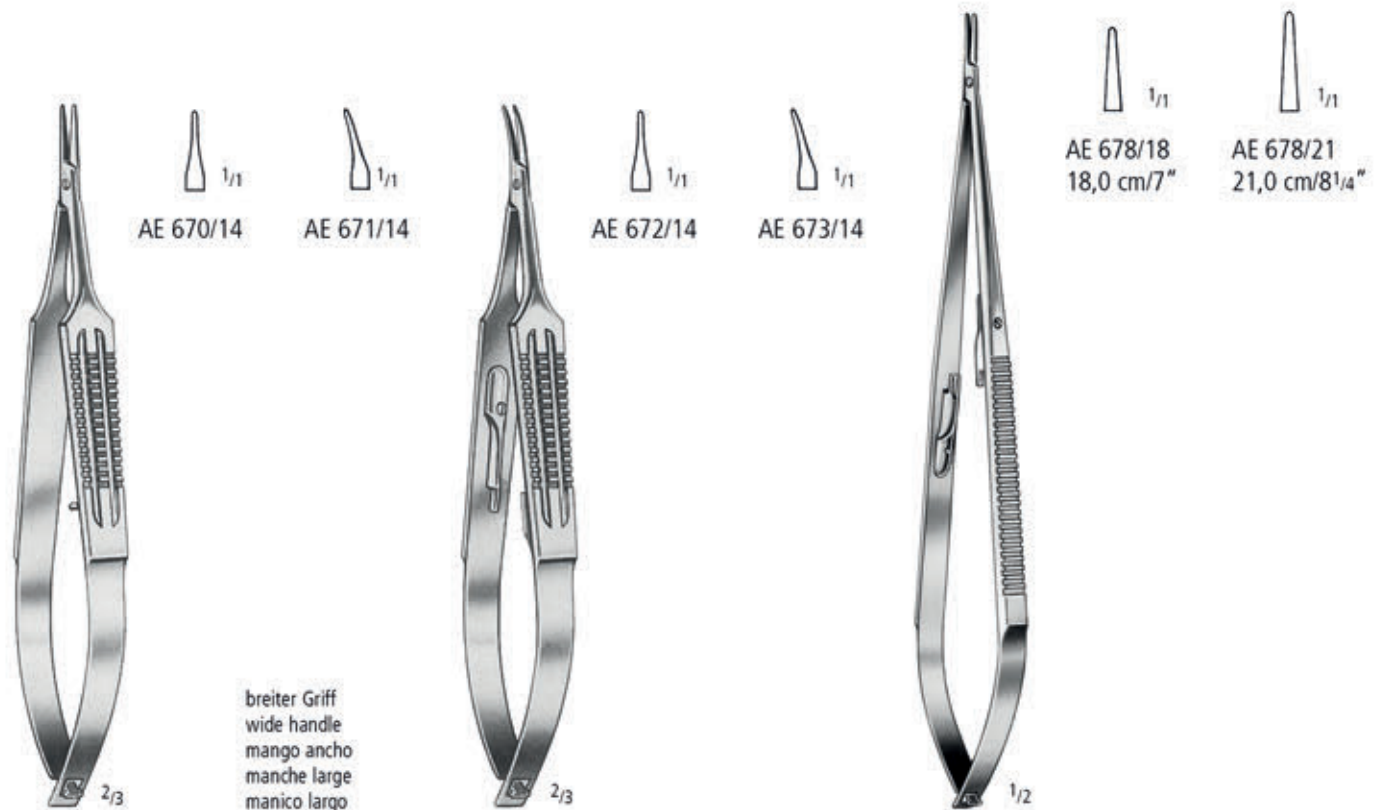

breiter Griff  
 wide handle  
 mango ancho  
 manche large  
 manico largo

**CASTROVIEJO**  
 14,0 cm/5 1/2"

**CASTROVIEJO**  
 14,0 cm/5 1/2"

**JACOBSON**

AA  
 AB  
 AC  
 AD  
**AE**  
 AK  
 AR  
 KA  
 KM  
 KO  
 KP  
 XR

**AE** NAHT SUTURE SUTURA SUTURE SUTURA

Mikro-Nadelhalter  
Micro-Needle-Holders  
Micro-porta-agujas  
Micro-porte-aiguilles  
Micro-portaghi



**PATON**  
AE 684/11  
11,0 cm/4<sup>1</sup>/<sub>2</sub>"



**PATON**  
AE 685/11  
11,0 cm/4<sup>1</sup>/<sub>2</sub>"

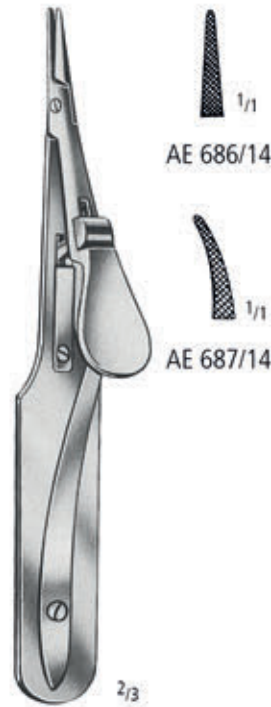

**ARRUGA**  
14,0 cm/5<sup>1</sup>/<sub>2</sub>"



**KALT**  
AE 688/14  
14,0 cm/5<sup>1</sup>/<sub>2</sub>"

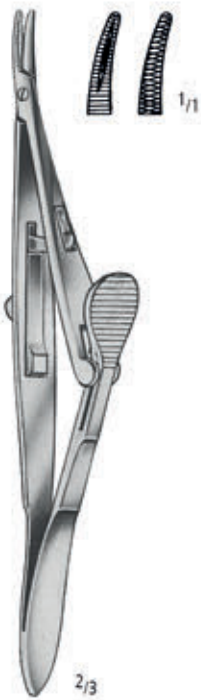

**KALT-ARRUGA**  
AE 689/14  
14,0 cm/5<sup>1</sup>/<sub>2</sub>"



**CASTROVIEJO-KALT**  
AE 690/14  
13,5 cm/5<sup>1</sup>/<sub>4</sub>"



**STEVENS**  
AE 692/13 13,0 cm/5"  
AE 692/15 15,0 cm/6"

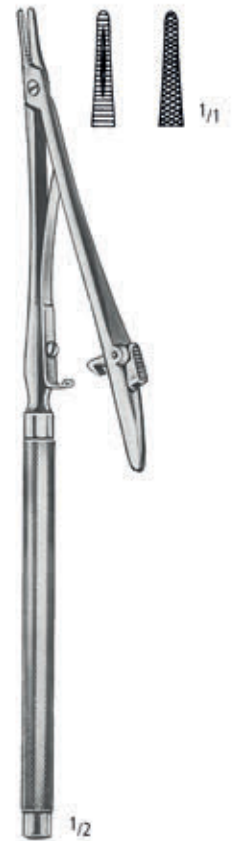

**POTTS-SMITH**  
AE 694/22  
22,0 cm/8<sup>3</sup>/<sub>4</sub>"

NAHT SUTURE SUTURA SUTURE SUTURA

Mikro-Nadelhalter mit Rundgriff  
 Micro-Needle-Holders with pen-type handle  
 Micro-porta-agujas con mango redondo  
 Micro-porte-aiguilles à manches rondes  
 Micro-portaghi con manici rotondi

AA

AB

AC

AD

AE

AK

AR

KA

KM

KO

KP

XR

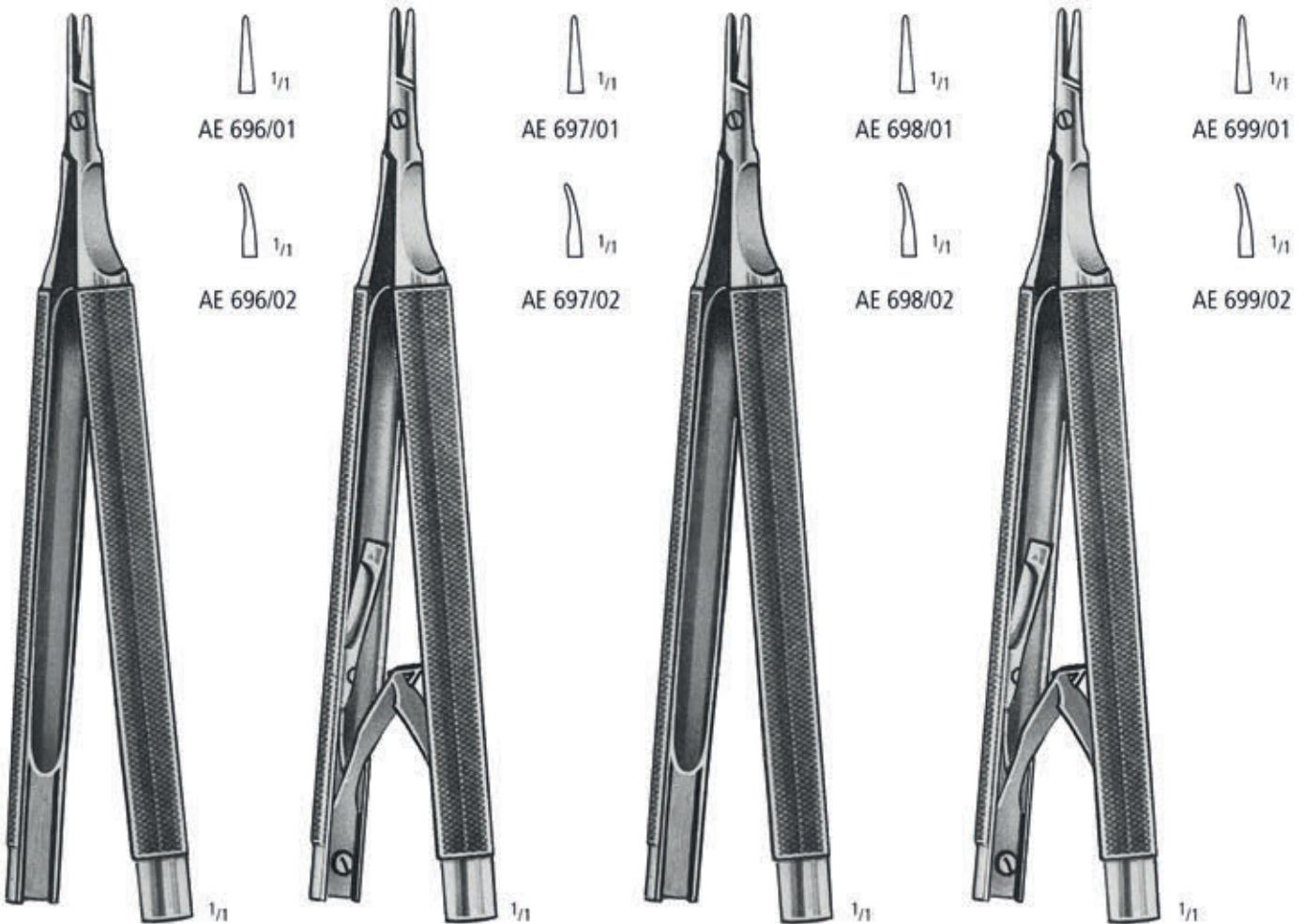

**CASTROVIEJO**  
 13,0 cm/5 1/4"

**CASTROVIEJO**  
 13,0 cm/5 1/4"

**CASTROVIEJO**  
 13,0 cm/5 1/4"

**CASTROVIEJO**  
 13,0 cm/5 1/4"

Ø Griff 8 mm  
 Ø Handle 8 mm  
 Ø Mango 8 mm  
 Ø Manche 8 mm  
 Ø Manico 8 mm

Ø Griff 10 mm  
 Ø Handle 10 mm  
 Ø Mango 10 mm  
 Ø Manche 10 mm  
 Ø Manico 10 mm



DIAGNOSTIK  
DIAGNOSTICS  
DIAGNOSTICO  
DIAGNOSTIC  
DIAGNOSTICA

AR

nopa<sup>®</sup> instruments

Weitere Naht-Instrumente finden Sie in unserem Katalog „Allgemeines Instrumentarium“ in Gruppe AE.

For further suture instruments kindly refer to our catalogue „General Instruments“, section AE.

Para instrumentos de sutura adicionales, por favor consulte nuestro catálogo de „Instrumental de uso general“, grupo AE.

Pour des instruments de suture supplémentaires, consultez notre catalogue „Instrumentation Generale“, section AE.

Per gli altri accessori di sutura, consultare il nostro catalogo „Strumentazione Generale“, gruppo AE.





Messinstrumente  
 Measuring Instruments  
 Instrumentos para medidas  
 Instruments pour mesurer  
 Strumenti per misurare

AA

AB

AC

AD

AE

AK

AR

KA

KM

KO

KP

XR



1/2

AR 250/15  
 15,0 cm/6"



1/1

**JAMESON**  
 AR 261/08  
 0 - 80 mm/0-3 inch



1/1

**CASTROVIEJO**  
 AR 282/15  
 8,0 cm/3 1/4"

Messbereich 15 mm  
 measuring range 15 mm  
 campo de medición 15 mm  
 étendue de mesurage 15 mm  
 ampiezza di misura 15 mm



1/1

**CASTROVIEJO**  
 AR 282/20  
 8,0 cm/3 1/4"

Messbereich 20 mm  
 measuring range 20 mm  
 campo de medición 20 mm  
 étendue de mesurage 20 mm  
 ampiezza di misura 20 mm



1/1

**CASTROVIEJO**  
 AR 283/20  
 8,0 cm/3 1/4"

Messbereich 20 mm  
 measuring range 20 mm  
 campo de medición 20 mm  
 étendue de mesurage 20 mm  
 ampiezza di misura 20 mm

Ophthalmoskop  
Ophthalmoscope  
Oftalmoscopio  
Ophthalmoscope  
Oftalmoscopio



**OTO- / OPHTHALMOSKOP**  
AR 402/00



**OPHTHALMOSKOP**  
AR 420/00



OPHTHALMOLOGIE  
OPHTHALMOLOGY  
OFTALMOLOGIA  
OPHTALMOLOGIE  
OFTALMOLOGIA

**KP**

**nopa**<sup>®</sup> instruments





Feine Wundhaken  
Delicate Hooks  
Ganchos  
Crochets très fins  
Divaricatori sottili

AA

AB

AC

AD

AE

AK

AR

KA

KM

KO

KP

XR



**GILLIES**  
AK 020/01  
18,0 cm/7"



**GILLIES**  
AK 020/02  
18,0 cm/7"



**KILNER**  
AK 022/15  
15,0 cm/6"



**FRAZIER**  
AK 024/13  
13,0 cm/5"



AK 026/01



**KLEINERT-KUTZ**  
AK 026/02  
16,0 cm/6¼"



AK 026/03

Feine Wundhaken  
 Delicate Hooks  
 Ganchos  
 Crochets très fins  
 Divaricatori sottili

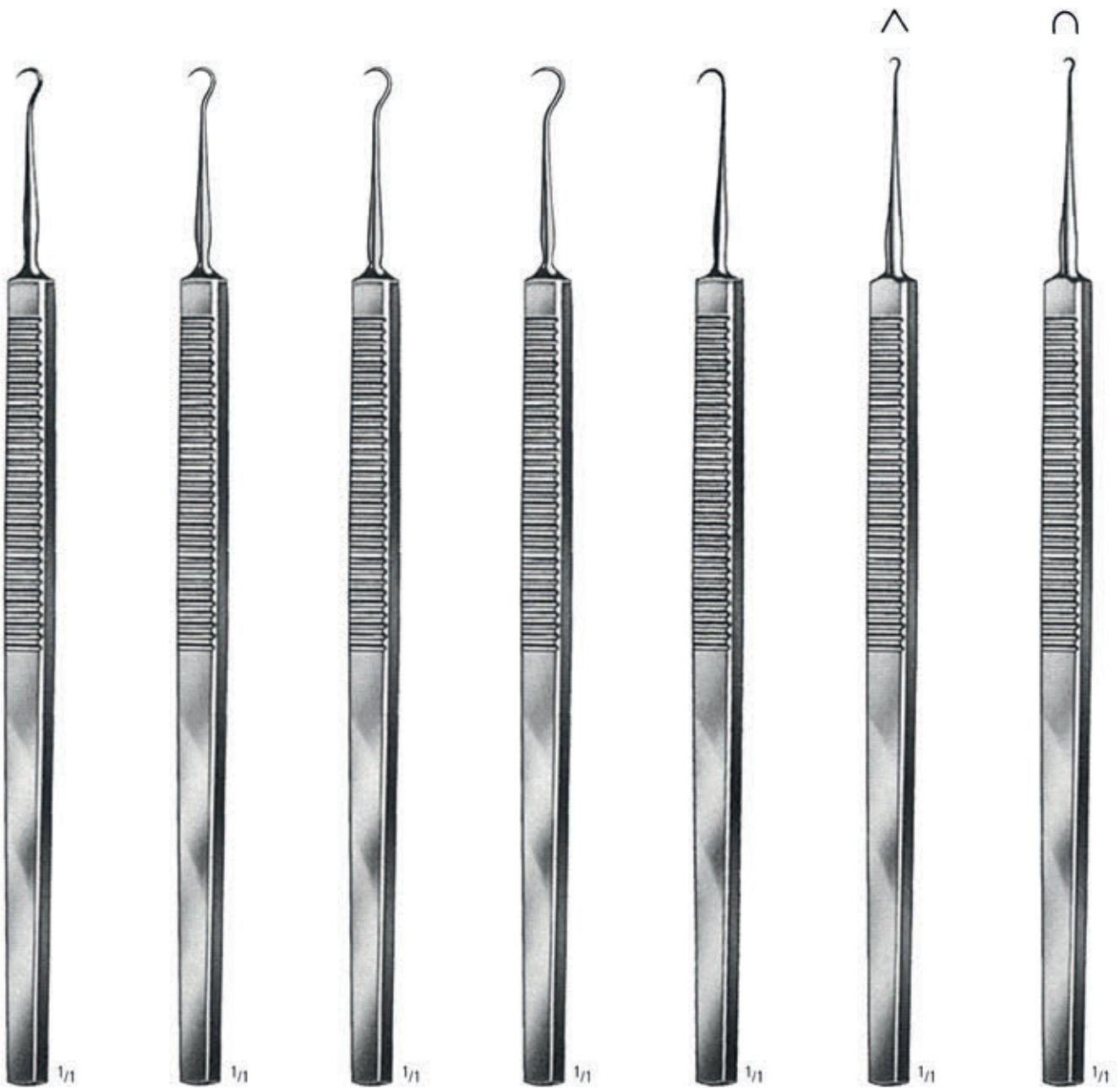

AK 028/01  
 16,0 cm/6<sup>1</sup>/<sub>4</sub>"

AK 028/02  
 16,0 cm/6<sup>1</sup>/<sub>4</sub>"

AK 028/03  
 16,0 cm/6<sup>1</sup>/<sub>4</sub>"

AK 028/04  
 16,0 cm/6<sup>1</sup>/<sub>4</sub>"

**O'CONNOR**  
 AK 030/16  
 16,0 cm/6<sup>1</sup>/<sub>4</sub>"

**GRAEFE**  
 AK 032/01  
 16,0 cm/6<sup>1</sup>/<sub>4</sub>"

**GRAEFE**  
 AK 032/02  
 16,0 cm/6<sup>1</sup>/<sub>4</sub>"

Feine Wundhaken  
Delicate Hooks  
Ganchos  
Crochets très fins  
Divaricatori sottili

AA

AB

AC

AD

AE

AK

AR

KA

KM

KO

KP

XR



**CUSHING**  
28,0 cm/11"



AK 034/01



AK 034/02



**CUSHING**  
19,0 cm/7½"



AK 036/01



AK 036/02



**MOLDESTAD**  
AK 038/13  
13,0 cm/5"



17,0 cm/6¾"



AK 040/05  
5 mm



AK 040/07  
7 mm



18,5 cm/7½"



AK 042/10  
Ø 1,0 mm



AK 042/12  
Ø 1,2 mm



AK 044/11  
11,0 cm/4⅓"

**AK** WUNDHAKEN RETRACTORS SEPARADORES ECARTEURS DIVARICATORI

Feine Wundhaken  
 Delicate Hooks  
 Ganchos  
 Crochets très fins  
 Divaricatori sottili

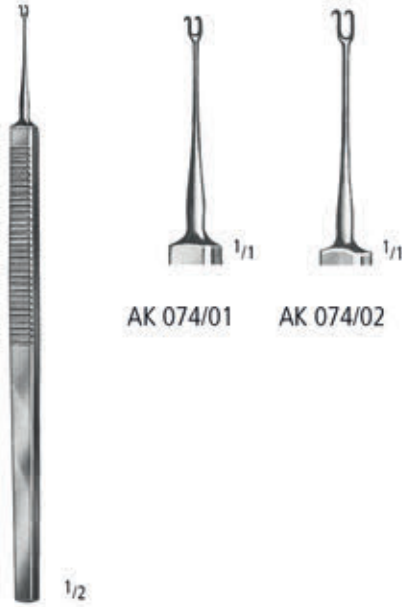

AK 074/01      AK 074/02

**GUTHRIE**  
 16,0 cm/6 1/4"



**ROLLET**  
 AK 076/13  
 13,0 cm/5"

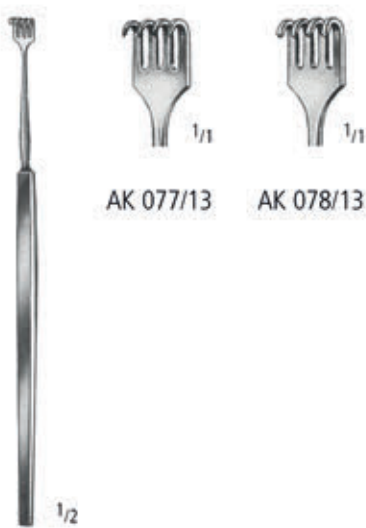

AK 077/13      AK 078/13

**KNAPP**  
 13,0 cm/5"



**DESMARRES**  
 13,0 cm/5"



AK 090/08  
 8 mm



AK 090/10  
 10 mm



AK 090/12  
 12 mm



AK 090/14  
 14 mm



AK 090/16  
 16 mm



AK 090/18  
 18 mm

Meißeln, Hammer und Hohlmeißelzangen  
 Chisels, Mallet and Bone Rongeurs  
 Cinceles, Martillo, Pinzas-gubias  
 Ciseaux-burins, Marteau, Pincas-gouges  
 Scalpelli, Martello e Pinze-sgorbie



Ø 22 mm  
 200 g  
 (7 oz.)

**PARTSCH**  
 13,5 cm/5<sup>1</sup>/<sub>4</sub>"

- KA 433/02
- KA 433/03
- KA 433/04
- KA 433/05
- KA 433/06
- KA 433/07

mm

- 2
- 3
- 4
- 5
- 6
- 7

- KA 443/02
- KA 443/03
- KA 443/04
- KA 443/05
- KA 443/06
- KA 443/07

**PARTSCH**  
 KA 545/20  
 18,0 cm/7"



**FRIEDMAN**  
 KA 800/14  
 14,0 cm/5<sup>1</sup>/<sub>2</sub>"



**LUER**  
 17,0 cm/6<sup>3</sup>/<sub>4</sub>"



**BÖHLER**  
 KA 825/01  
 15,0 cm/6"

AA  
 AB  
 AC  
 AD  
 AE  
 AK  
 AR  
 KA  
 KM  
 KO  
 KP  
 XR

Stanzen  
Punches  
Pinzas osteótomas  
Pinces ostéotomes  
Pinze osteotomi



**CITELLI**



KM 490/01  
1 mm



KM 490/02  
2 mm



KM 490/03  
3 mm



NASE RHINOLOGY RINOLOGIA RHINOLOGIE RINOLOGIA

Nasenspekula, Keilbeinstanzen  
 Nasal Specula, Sphenoid Punches  
 Espéculos nasales, Pinzas para seno esfenoidal  
 Spéculums nasaux, Pinces pour sinus sphénoïdal  
 Specoli nasali, Pinze per seno sfenoidale

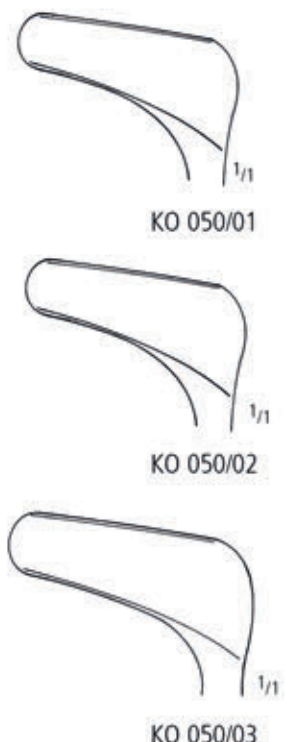

**HARTMANN-HALLE**  
 15,0 cm/6"



3 x 3 mm  
 KO 275/90  
 4 x 4 mm  
 KO 276/90  
 5 x 5 mm  
 KO 277/90

**KERRISON**

Hohlmeißel  
 Gouges  
 Gubias  
 Gouges  
 Sgorbie



**WEST**  
 KO 604/04  
 16,0 cm/6 1/4"



**WEST**  
 KO 605/04  
 16,0 cm/6 1/4"

AA  
 AB  
 AC  
 AD  
 AE  
 AK  
 AR  
 KA  
 KM  
 KP  
 XR

KO

Muskel-, Netzhautablösungs- und Schielhaken  
 Muscle, Retinal Detachment and Strabismus Hooks  
 Ganchos de músculos, para desprendimiento de retina y para estrabismo  
 Crochets musculaires, de décollement de la rétine et à strabisme  
 Uncinetti per muscoli e per strabismo



Sehnenhäkchen, Fixiergabel  
 Tenotomy Hook, Fixation Fork  
 Gancho de tenotomía, Horquilla fijadora  
 Crochet pour tenotomie, Pique de fixation  
 Uncinetti de tendini e per fissazione



**STEVENS**  
 KP 018/12  
 12,0 cm/4<sup>3</sup>/<sub>4</sub>"



**BURCH**  
 KP 020/13  
 13,0 cm/5"



KP 023/01  
 11,0 cm/4<sup>1</sup>/<sub>2</sub>"

rechts  
 right  
 derecha  
 droit  
 destra

KP 023/02  
 11,0 cm/4<sup>1</sup>/<sub>2</sub>"

links  
 left  
 izquierda  
 gauche  
 sinistra

Irishäkchen  
Iris Hooks  
Ganchos para iris  
Crochets à iris  
Uncinetti per l'iride



sehr fein, scharf  
very delicate, pointed  
delicadísimo, afilado  
très fin, coupant  
fino, tagliente

**BONN**  
KP 025/14  
13,5 cm/5<sup>1</sup>/<sub>4</sub>"



stumpf  
blunt  
romo  
émoussé  
smussato

**KNOLLE**  
KP 026/11  
11,0 cm/4<sup>1</sup>/<sub>2</sub>"

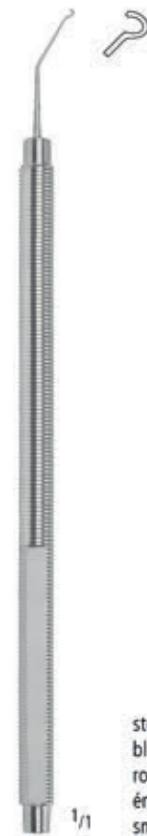

stumpf, abgewinkelt  
blunt, angled  
romo, angular  
émoussé, coudé  
smussato, angolato

**JAFFE-KNOLLE**  
KP 027/12  
12,0 cm/4<sup>3</sup>/<sub>4</sub>"

Irishäkchen  
 Iris Hooks  
 Ganchos para iris  
 Crochets à iris  
 Uncinetti per l'iride

AA

AB

AC

AD

AE

AK

AR

KA

KM

KO

KP

XR



1/1

**TYRELL**  
 12,0 cm/4<sup>3</sup>/<sub>4</sub>"



KP 029/01

stumpf  
 blunt  
 romo  
 émoussé  
 smussato



KP 029/02

scharf  
 pointed  
 afilado  
 coupant  
 tagliente



1/1

**HIRSCHMANN**  
 KP 030/13  
 12,5 cm/5"

Linsenkernwender, Linsenmanipulator  
 Lens Nucleus Rotators, Lens Manipulators  
 Ganchos para voltear nucleo y para posicionar cristalino  
 Crochets pour tourner, Crochets manipulateurs à cristallin  
 Uncinetti per rotazione di nucleo cristallino, Uncini per posizionare cristallino

## TITANIUM

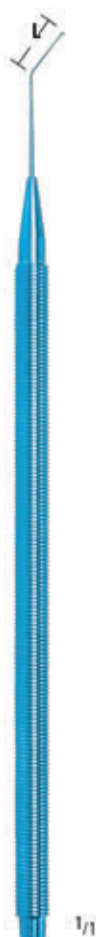

**BECHERT**  
 KP 040/01  
 12,0 cm/4<sup>3</sup>/<sub>4</sub>"  
 L = 7 mm

V-Spitze  
 V-tip  
 punta V  
 coudé à fourche  
 punta V



**JAFFE-BECHERT**  
 KP 040/02  
 12,0 cm/4<sup>3</sup>/<sub>4</sub>"  
 L = 9 mm

V-Spitze  
 V-tip  
 punta V  
 coudé à fourche  
 punta V



**CLAYMAN**  
 KP 040/03  
 12,5 cm/5"  
 L = 10 mm

V-Spitze  
 V-tip  
 punta V  
 coudé à fourche  
 punta V

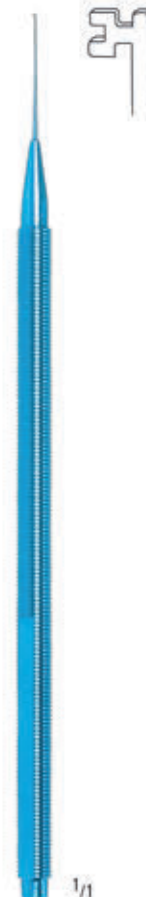

**OSHER**  
 KP 050/12  
 12,0 cm/4<sup>3</sup>/<sub>4</sub>"



Linsenkernelmanipulatoren, Phakohaken  
 IOL Manipulators, Phaco Splitter  
 Ganchos para manipular de nucleo, Ganchos para faco  
 Crochets pour manipuler le noyau, Crochets à phaco  
 Uncini per posizionare cristallino, Uncini per faco

AA

AB

AC

AD

AE

AK

AR

KA

KM

KO

KP

XR

# TITANIUM



**DRYSDALE**  
 KP 051/12  
 12,0 cm/4<sup>3</sup>/<sub>4</sub>"



**BUNNKATU**  
 KP 057/12  
 12,0 cm/4<sup>3</sup>/<sub>4</sub>"

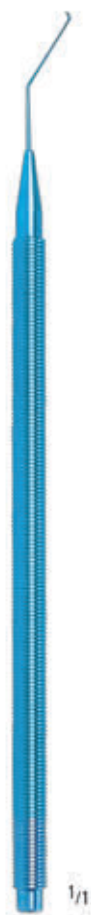

Klinge  
 blade  
 hoja  
 lame  
 lame

60°

Klinge  
 blade  
 hoja  
 lame  
 lame

60°



**ROSEN**

12,0 cm/4<sup>3</sup>/<sub>4</sub>"

KP 065/60

KP 065/90

90°

stumpfes Eck  
 blunt edge  
 canto romo  
 coin mousse  
 angolo smussato

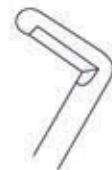

**NAGAHARA**

12,0 cm/4<sup>3</sup>/<sub>4</sub>"

KP 067/60

KP 067/90

90°

stumpfes Eck  
 blunt edge  
 canto romo  
 coin mousse  
 angolo smussato

IOL Positionshäkchen  
 Lens Manipulators  
 Ganchos para posicionar cristalino  
 Crochets manipulateurs à cristallin  
 Uncini per posizionare cristallino

# TITANIUM



KP 070/20  
 KP 070/25

**SINSKEY**  
 12,0 cm/4<sup>3</sup>/<sub>4</sub>"

Ø 0,20 mm  
 Ø 0,25 mm

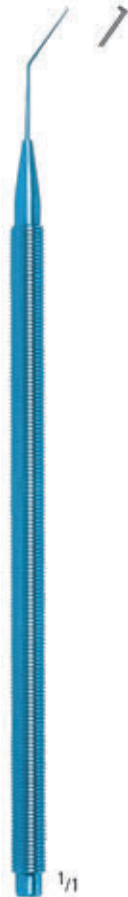

KP 071/20  
 KP 071/25

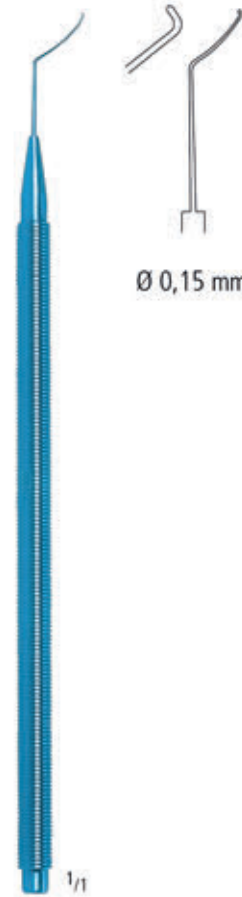

**LEWICKY**  
 KP 075/15  
 12,0 cm/4<sup>3</sup>/<sub>4</sub>"

Ø 0,15 mm



IOL Positionshäkchen  
 Lens Manipulators  
 Ganchos para posicionar cristalino  
 Crochets manipulateurs à cristallin  
 Uncini per posizionare cristallino

AA

AB

AC

AD

AE

AK

AR

KA

KM

KO

KP

XR

# TITANIUM



**LESTER**  
 KP 077/01  
 12,0 cm/4<sup>3</sup>/<sub>4</sub>"



KP 077/02  
 12,0 cm/4<sup>3</sup>/<sub>4</sub>"



**LESTER**



KP 077/03  
 12,0 cm/4<sup>3</sup>/<sub>4</sub>"

gewölbt  
 vaulted  
 abovedado  
 cintré  
 convesso



**JAFFE-MALTMANN**

KP 081/12  
 12,0 cm/4<sup>3</sup>/<sub>4</sub>"

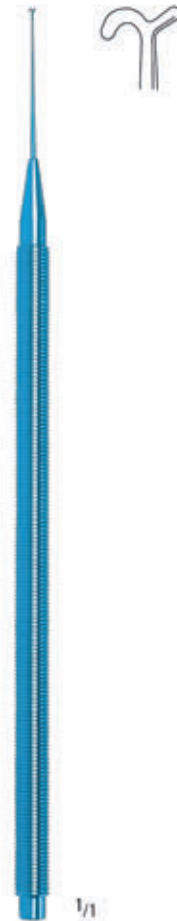

**RENTSCH**  
 KP 085/12  
 12,0 cm/4<sup>3</sup>/<sub>4</sub>"



Tränenkanalsonden  
 Lacrimal Probes  
 Sondas exploradoras para canal lacrimal  
 Sondes exploratrices pour le canal lacrymal  
 Sonde esploratrici per canale lacrimale

AA

AB

AC

AD

AE

AK

AR

KA

KM

KO

KP

XR



geknöpft  
 pointed  
 con botón  
 boutoné  
 bottenuto

- KP 114/00
- KP 115/00
- KP 115/01
- KP 115/12
- KP 115/23
- KP 115/34
- KP 115/45
- KP 115/56
- KP 115/67
- KP 115/78

Fig.	mm Ø
0000/00	0,4 / 0,6
00/0	0,7 / 0,8
0/1	0,8 / 0,9
1/2	0,9 / 1,1
2/3	1,1 / 1,3
3/4	1,3 / 1,4
4/5	1,4 / 1,5
5/6	1,5 / 1,6
6/7	1,6 / 1,8
7/8	1,8 / 1,9



zylindrisch  
 cylindrical  
 cilindrica  
 cylindrique  
 cilindrico

- KP 116/00
- KP 117/00
- KP 117/01
- KP 117/12
- KP 117/23
- KP 117/34
- KP 117/45
- KP 117/56
- KP 117/67
- KP 117/78



**BOWMAN**  
 12,5 cm/5"

aus Silber  
 Sterling silver  
 de plata pura  
 en argent pur  
 in argento puro

**BOWMAN**  
 12,5 cm/5"

Tränenkanaldilatatoren  
 Lacrimal Dilators  
 Dilatadoras para canal lacrimal  
 Dilatateurs pour le canal lacrymal  
 Dilatatori per canale lacrimale



KP 120/01  
Fig. 1



KP 120/02  
Fig. 2



KP 120/03  
Fig. 3

1/1

**WILDER**  
10 cm/4"



**MULDOON**  
KP 121/11  
10,5 cm/4 1/4"



**RUEDEMANN**  
KP 122/07  
7 cm/2 3/4"

Tränenkanaldilatatoren, Trabekularsonden, Pigtail Sonde  
 Lacrimal Dilators, Trabecular Probes, Pigtail Probe  
 Diladoras para canal lacrimal, Sondas trabeculares, Sonda pigtail  
 Dilateurs pour le canal lacrymal, Sondes trabéculaires, Sonde spiralée  
 Dilatori per canale lacrimale, Sonde trabecolari, Sonda a pigtail

AA

AB

AC

AD

AE

AK

AR

KA

KM

KO

KP

XR



**CASTROVIEJO**  
 KP 123/14  
 14 cm/5 1/2"



KP 130/01

rechts  
 right

derecha  
 droit  
 destra



**HARMS**  
 4,5 cm/1 3/4"

KP 130/02

links  
 left

izquierda  
 gauche  
 sinistra

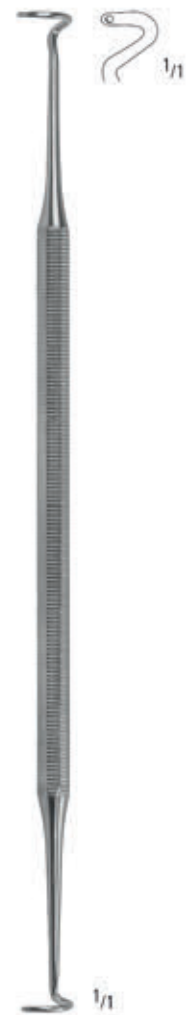

**WORST**  
 KP 135/14  
 13,5 cm/5 1/4"

Lidsperrer  
Eye Specula  
Blefarostatos  
Bléfarostats  
Blefarostati

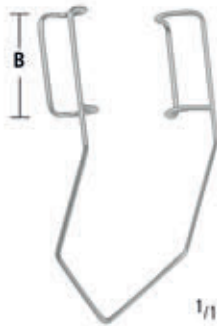

**BARRAQUER-COLIBRI**

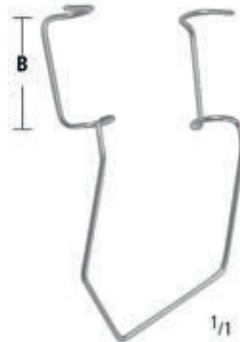

**KRATZ-BARRAQUER**



**BARRAQUER**

geschlossene Valven  
solid blades  
hojas sólidas  
cuillers plaines  
valve massiccio

Frühgeborene  
Premature infant  
Parto prematuro  
Accouchement prématuré  
Parto prematuro

**B**  
5 mm KP 150/05  
3,0 cm/1<sup>1</sup>/<sub>4</sub>"

**B**  
10 mm KP 151/10  
4,0 cm/1<sup>1</sup>/<sub>2</sub>"

**B**  
10 mm KP 152/10  
4,0 cm/1<sup>1</sup>/<sub>2</sub>"

Kind  
Child  
Niños  
Enfants  
Bambini

10 mm KP 150/10  
3,0 cm/1<sup>1</sup>/<sub>4</sub>"

10 mm KP 151/10  
4,0 cm/1<sup>1</sup>/<sub>2</sub>"

10 mm KP 152/10  
4,0 cm/1<sup>1</sup>/<sub>2</sub>"

Erwachsene  
Adults  
Adultos  
Adultes  
Adulti

15 mm KP 150/15  
4,0 cm/1<sup>1</sup>/<sub>2</sub>"

14 mm KP 151/14  
4,5 cm/1<sup>3</sup>/<sub>4</sub>"

15 mm KP 152/15  
4,0 cm/1<sup>1</sup>/<sub>2</sub>"



**BARRAQUER PHAKO**  
KP 154/04  
4,0 cm/1<sup>1</sup>/<sub>2</sub>"



**BOWMAN**  
KP 160/07  
7,0 cm/2<sup>3</sup>/<sub>4</sub>"

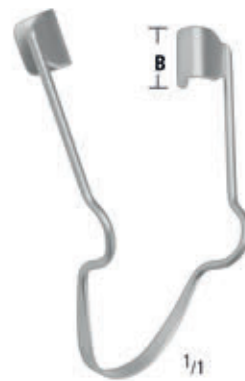

**CORCELLE**  
KP 161/05  
5,0 cm/ 2"  
**B = 8 mm**



**WILLIAMS**  
KP 162/09  
9,0 cm/3<sup>1</sup>/<sub>2</sub>"  
**B = 14 mm**

Lidsperrer  
Eye Specula  
Blefarostatos  
Blépharostats  
Blefarostati

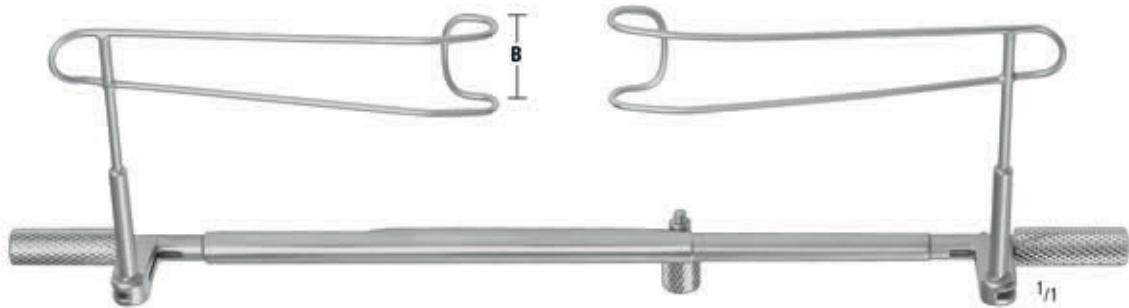

**SCHOTT**  
15,0 cm/6"

Kind  
Child  
Niños  
Enfants  
Bambini

**B**  
12 mm KP 170/12

Erwachsene  
Adults  
Adultos  
Adultes  
Adulti

**B**  
15 mm KP 170/15



**CASTROVIEJO**  
KP 175/09  
9,0 cm/3<sup>1</sup>/<sub>2</sub>"  
**B** = 16 mm



**MAUMENEE-PARK**  
KP 176/09  
8,5 cm/3<sup>1</sup>/<sub>4</sub>"



**MAUMENEE-PARK**  
KP 177/09  
8,5 cm/3<sup>1</sup>/<sub>4</sub>"

AA

AB

AC

AD

AE

AK

AR

KA

KM

KO

**KP**

XR

Lidsperrer  
Eye Specula  
Blefarostatos  
Blépharostats  
Blefarostati



**PLEY**  
KP 185/07  
6,5 cm/2 1/2"



**LANCASTER**  
KP 186/08  
8,0 cm/3 1/4"



**LESTER-BURCH**  
KP 187/08  
8,0 cm/3 1/4"



**COOK**

	<b>B</b>	
Kind Child Niños Enfants Bambini	10 mm	KP 200/10 4,0 cm/1 1/2"
Erwachsene Adults Adultos Adultes Adulti	15 mm	KP 200/15 5,0 cm/ 2"



**SAUER**

	<b>B</b>	
Kind Child Niños Enfants Bambini	8 mm	KP 205/08 3,0 cm/1 1/4"



Lidsperr  
Eye Specula  
Blefarostatos  
Blépharostats  
Blefarostati

AA

AB

AC

AD

AE

AK

AR

KA

KM

KO

KP

XR



V-förmig  
V-shaped  
forma V  
forme V  
forme V

**LIEBERMAN**  
KP 210/01  
8,0 cm/3 1/4"  
B = 15 mm



K-förmig  
K-shaped  
forma K  
forme K  
forme K

**LIEBERMAN**  
KP 210/02  
8,0 cm/3 1/4"  
B = 15 mm



**LIEBERMAN**  
KP 211/08  
8,0 cm/3 1/4"  
B = 15 mm



**LIEBERMAN**  
KP 212/08  
8,0 cm/3 1/4"  
B = 15 mm

Tränensackspreizer, Lidplatte  
 Lacrimal Sac Retractors, Lid Plate  
 Separadores para saco lacrimal, Placa para párpados  
 Ecarteurs à sac lacrymal, Plaque à paupières  
 Divaricatore per sacco lacrimale, Elevatori per palpebre



**STEVENSON**  
 KP 230/08  
 7,5 cm/3"



**AGRICOLA**  
 KP 232/05  
 4,5 cm/1<sup>3</sup>/<sub>4</sub>"



**JAEGER**  
 KP 248/11  
 11,0 cm/4<sup>1</sup>/<sub>2</sub>"



Paar  
 Pair  
 Par  
 Paire  
 Paio

**JAFFE**  
 4,0 cm/1<sup>1</sup>/<sub>2</sub>"

**B**  
 10 mm      KP 245/10  
 Kind  
 Child  
 Niños  
 Enfants  
 Bambini

**B**  
 15 mm      KP 245/15  
 Erwachsene  
 Adults  
 Adultos  
 Adultes  
 Adulti

Orbitalretractoren und -spatel, Wundlöffel  
 Orbital Retractors and Spatulas, Protector  
 Separadores y espátulas orbitales, Protector  
 Ecarteurs et spatules à orbite, Protecteur  
 Divaricatori orbitale, Spatole per orbita, Protettore

AA  
 AB  
 AC  
 AD  
 AE  
 AK  
 AR  
 KA  
 KM  
 KO  
 KP  
 XR

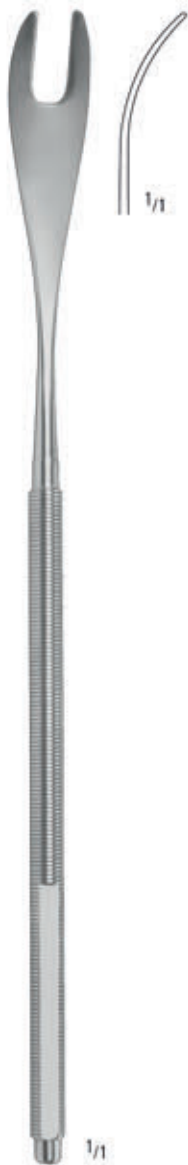

**SCHEPENS**  
 KP 260/16  
 15,5 cm/6<sup>1</sup>/<sub>4</sub>"



**SAUTER**  
 KP 261/15  
 15,0 cm/6"



**ARRUGA**  
 KP 262/13  
 13,0 cm/5"



**LASIK**  
 KP 270/10  
 10,0 cm/4"

Depressor, Sklera Marker  
 Depressors, Scleral Markers  
 Depresores, Marcadores de esclerótica  
 Dépresseurs, Marqueur scléral  
 Depressore, Marcadori sclerali



**SCHOCKET**  
 KP 280/14  
 14,0 cm/5 1/2"



**GASS**  
 KP 285/05  
 4,5 cm/1 3/4"  
 Ø 1,5 mm



**SCHEPENS**  
 4,0 cm/1 1/2"

KP 290/08  
 Fig. 8

klein  
 small  
 pequeño  
 petit  
 piccolo

KP 290/10  
 Fig. 10

medium  
 medium  
 medio  
 moyen  
 medio

KP 290/12  
 Fig. 12

groß  
 large  
 grande  
 grand  
 grande

Hornhautmesser und -schaber, Diszisionmesser  
 Corneal Knives and Scarifiers, Discission Knives  
 Cuchillos y Rescadores para la córnea, Cuchillos para discisión  
 Kératomes, Grattoirs cornéens, Couteaux à discision  
 Coltelli per cornea, Raschiatoi corneali, Coltelli per discissione

AA  
AB  
AC  
AD  
AE  
AK  
AR  
KA  
KM  
KO  
KP  
XR



**SATO**  
 KP 300/12  
 12,0 cm/ 4<sup>3</sup>/<sub>4</sub>"  
 5 mm



**GILL**  
 KP 302/13  
 12,5 cm/4<sup>1</sup>/<sub>2</sub>"  
 3 mm

gerade  
 straight  
 recto  
 droit  
 rette



KP 303/12  
 11,5 cm/ 5"  
 3 mm

gebogen  
 curved  
 curvas  
 courbes  
 curve



**TOOK**  
 KP 305/11  
 11,0 cm/ 4<sup>1</sup>/<sub>4</sub>"  
 3 x 18 mm



**KUHNT**  
 KP 309/11  
 11,0 cm/ 4<sup>1</sup>/<sub>4</sub>"  
 3 x 5 mm



**ZIEGLER**  
 11,0 cm/ 4<sup>1</sup>/<sub>4</sub>"  
 KP 310/03  
 3 mm



KP 310/05  
 5 mm



**WHEELER**  
 KP 312/11  
 11,0 cm/ 4<sup>1</sup>/<sub>4</sub>"  
 1 x 18 mm

Star-, Sklera-, Goniotomiemesser  
 Cataract, Sclera and Goniotomy Knives  
 Cuchillos para catarata, para esclerótica, para goniotomía  
 Couteaux à cataracte, pour la sclère, à goniotomie  
 Coltelli per cataratta, sclerali e per goniotomia



KP 320/20  
 12,0 cm/ 4<sup>3</sup>/<sub>4</sub>"  
 20 mm



KP 320/25  
 12,5 cm/ 5"  
 25 mm

**GRAEFE**

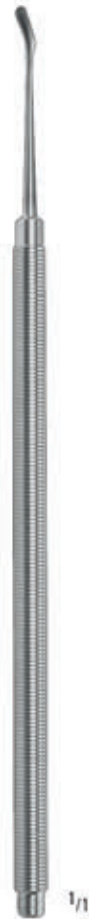

KP 325/05  
 12,5 cm/ 5"  
 5 mm



KP 325/06  
 12,5 cm/ 5"  
 6 mm

**BONN**



**BARKAN**  
 KP 330/12  
 12,0 cm/ 4<sup>3</sup>/<sub>4</sub>"  
 2 mm

Luftlanze, Keratoplastikmesser, Zystotome  
 Keratome, Keratoplasty Knives, Cystotomes  
 Querátomo, Cuchillos para queratoplástica, Quistótomos  
 Couteaux lancéolaires, Couteaux pour kératoplastie, Cystotomes  
 Coltelli lanceolari, Coltelli per cheratoplastica, Cistotomi

AA

AB

AC

AD

AE

AK

AR

KA

KM

KO

KP

XR

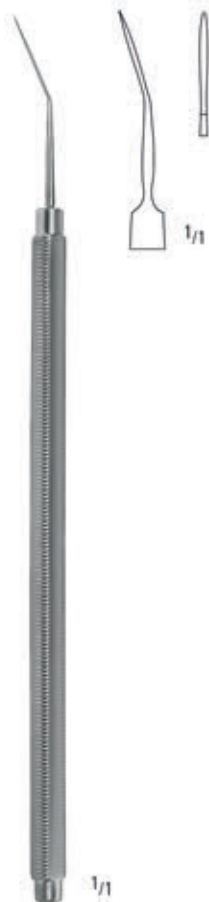

**MOD. HAMBURG**  
 KP 335/12  
 12,0 cm/ 4<sup>3</sup>/<sub>4</sub>"

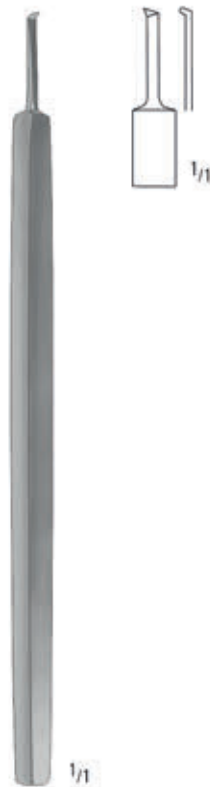

**PAUFIQUE**  
 KP 340/11  
 10,5 cm/ 4<sup>1</sup>/<sub>4</sub>"



**GRAEFE**  
 KP 346/13  
 12,5 cm/ 5"

biegsam  
 malleable  
 maleable  
 malleable  
 malleabile

Fremdkörpernadeln, -hohlmeißel und -meißel  
 Foreign Body Needles, Gouges and Spuds  
 Agujas, Gubias y Cinceles para cuerpos extraños  
 Aiguilles, Gouges et Ciseaux-burins à corps étrangers  
 Aghi, Sgorbie e Scalpelli per corpi estranei



KP 350/12

umschraubbar  
 reversible  
 reversible  
 révisible  
 rivoltabile

KP 350/13

umschraubbar  
 reversible  
 reversible  
 révisible  
 rivoltabile



1/1



KP 351/01



KP 351/02



KP 351/03



Fremdkörpernadeln und -meißel  
 Foreign Body Needles and Spuds  
 Aguja y Cinceles para cuerpos extraños  
 Aiguilles et Ciseaux-burins à corps étrangers  
 Aghi e Scalpelli per corpi estranei

AA

AB

AC

AD

AE

AK

AR

KA

KM

KO

KP

XR



KP 354/12  
 12,0 cm/ 4<sup>3</sup>/<sub>4</sub>"



KP 355/12  
 12,0 cm/ 4<sup>3</sup>/<sub>4</sub>"



**DAVIS**  
 KP 360/12  
 12,0 cm/ 4<sup>3</sup>/<sub>4</sub>"

scharf, rund  
 sharp, round  
 afilado, redondo  
 coupant, rond  
 tagliente, rotondo



**ELLIS**  
 KP 361/12  
 11,5 cm/4<sup>1</sup>/<sub>2</sub>"

gebogen, rund  
 curved, round  
 curvado, redondo  
 courbe, rond  
 curvo, rotondo



**FRANCIS**  
 KP 363/12  
 12,0 cm/ 4<sup>3</sup>/<sub>4</sub>"



**GOLF-CLUB**  
 KP 364/12  
 11,5 cm/4<sup>1</sup>/<sub>2</sub>"

Fremdkörpernadeln, -hohlmeißeln und -meißeln, Augenmagnet mit Fremdkörperschlinge  
 Foreign Body Needles, Gouges and Spuds, Magnetic Eye Probe with Foreign Body Loop  
 Agujas, Gubias y Cinceles para cuerpos extraños, Imán oftálmico con asa para cuerpos extraños  
 Aiguilles, Gouges et Ciseaux-burins à corps étrangers, Aimant oculaire avec anse pour corps étrangers  
 Aghi, Sgorbie e Scalpelli per corpi estranei, Calamita per occhi con ansa per corpi estranei

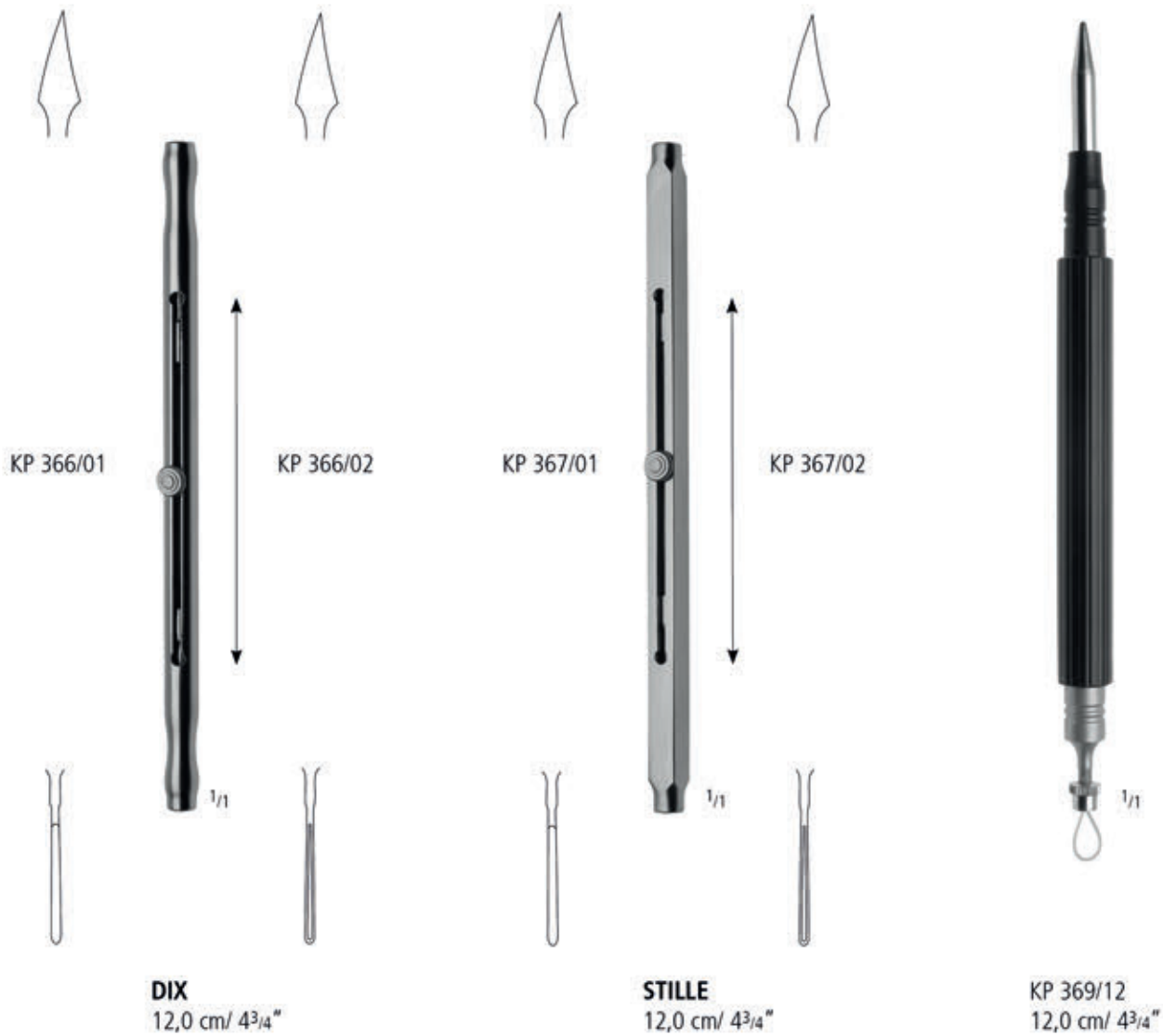

Diamantmesser  
Diamond Knives  
Bisturis de diamante  
Couteaux de diamant  
Coltelli di diamanti

AA

AB

AC

AD

AE

AK

AR

KA

KM

KO

**KP**

XR

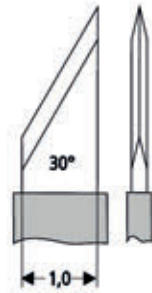

KP 370/01

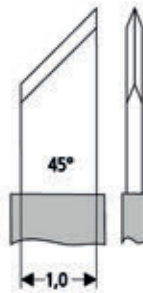

KP 370/02

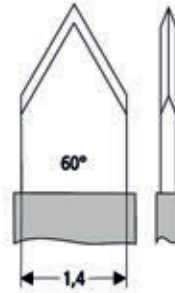

KP 370/03

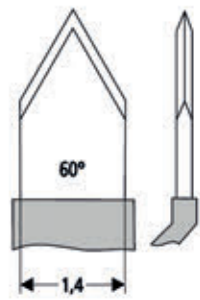

KP 370/04

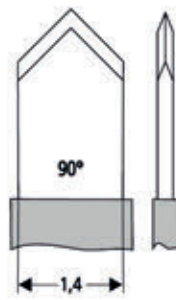

KP 370/05

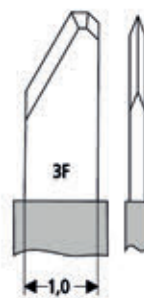

KP 371/01

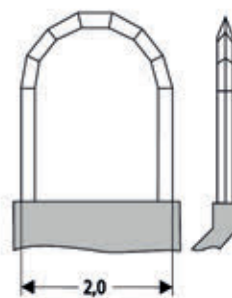

KP 371/02



1/1

Diamantmesser  
 Diamond Knives  
 Bisturis de diamante  
 Couteaux de diamant  
 Coltelli di diamanti

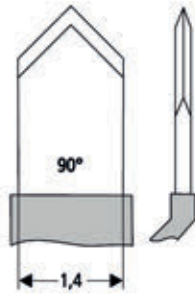

KP 373/01

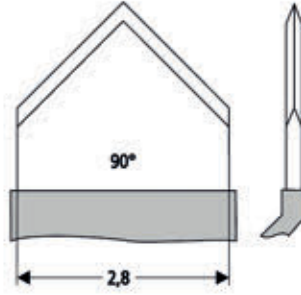

KP 373/02

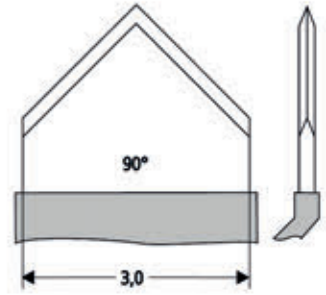

KP 373/03



1/1

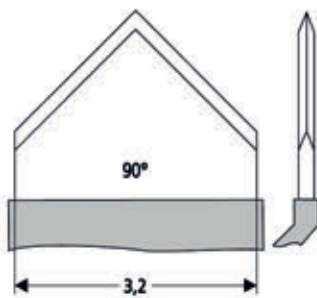

KP 373/04

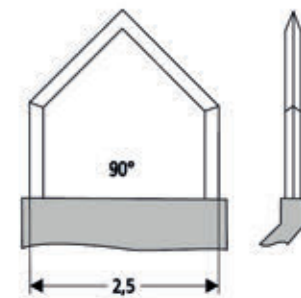

KP 373/05

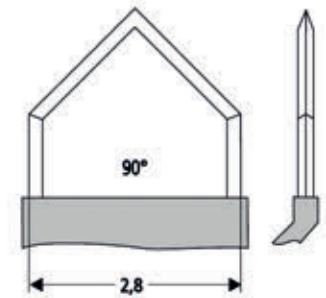

KP 373/06

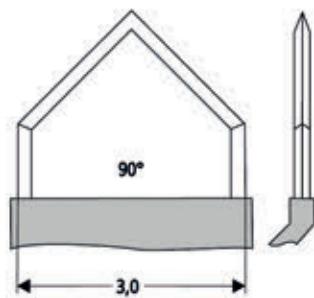

KP 373/07

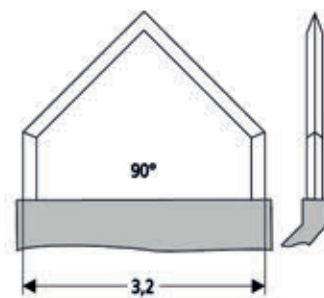

KP 373/08

Diamantmesser  
Diamond Knives  
Bisturis de diamante  
Couteaux de diamant  
Coltelli di diamanti

AA

AB

AC

AD

AE

AK

AR

KA

KM

KO

KP

XR



1/1

mit Mikrometer  
with micrometer  
con micrómetro  
avec micromètre  
con micrometro



KP 375/01

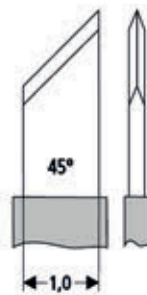

KP 375/02

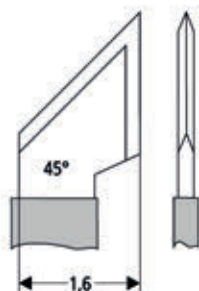

KP 375/03



1/1

7 Stufen:  
7 steps:  
7 escalones:  
7 étages:  
7 gradi:

0 / 0,3 / 0,4 / 0,5 / 0,6 / 0,8 / 1,0 / 2,5 mm

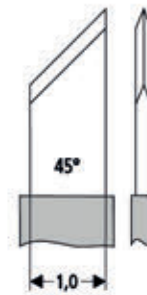

KP 376/01

Vitrektomiescheren  
 Vitrectomy Scissors  
 Tijeras de vitrectomía  
 Ciseaux pour vitrectomie  
 Forbici per vitrectomia



KP 390/00  
0°



KP 390/30  
30°



60° KP 390/60  
90° KP 390/90

ohne Spülung  
 without irrigation  
 sin irrigaciòn  
 sans irrigation  
 senza irrigazione

mit Spülung  
 with irrigation  
 con irrigaciòn  
 avec irrigation  
 con irrigazione

KP 391/00  
0°

KP 391/30  
30°

Vitrektomiefasszangen  
 Vitrectomy Grasping Forceps  
 Pinzas de vitrectomia  
 Pincas pour vitrectomie  
 Pinze per vitrectomia

AA

AB

AC

AD

AE

AK

AR

KA

KM

KO

KP

XR



KP 394/00



KP 395/01



KP 395/02



KP 395/03



0,30 mm  
0,44 mm

KP 396/30  
KP 396/44



KP 397/45  
45°



KP 397/90  
90°

Exenterations- und Enukleationslöffel  
 Exenteration- and Enucleation Spoons  
 Cucharas para exenteración y para enucleación  
 Cuillers à éviscération et à énucléation  
 Cucchiari da enucleazione



**BUNGE**



KP 400/01  
 14,0 cm/5 1/2"



KP 400/02  
 14,0 cm/5 1/2"



**WELLS**



KP 405/14  
 14,0 cm/5 1/2"



KP 405/15  
 15,0 cm/6"



Starlöffel, Chalazionlöffel  
 Corneal Button Transfer Spoon, Chalazion Curettes  
 Cucharas para transferir la córnea, Cucharillas para chalazión  
 Cuillers pour transférer la cornée, Cuillers à chalazion  
 Anse per cristallino, Cucchiari per calazio

AA

AB

AC

AD

AE

AK

AR

KA

KM

KO

KP

XR



**KNAPP**  
 KP 410/14  
 13,5 cm/5 1/4"

für Hornhauttransfer  
 for corneal button transfer  
 para transferir la córnea  
 pour transférer la cornée  
 per transferire la cornea

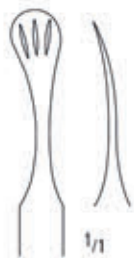

**CASTROVIEJO**  
 KP 411/12  
 12,0 cm/4 3/4"



**MEYHOEFER**  
 13,0 cm/5"



KP 415/10  
 Ø 1,0 mm



KP 415/15  
 Ø 1,5 mm



KP 415/18  
 Ø 1,8 mm



KP 415/20  
 Ø 2,0 mm



KP 415/25  
 Ø 2,5 mm



KP 415/30  
 Ø 3,0 mm



KP 415/35  
 Ø 3,5 mm

Chalazionlöffel, Starlöffel, Starschlingen  
 Chalazion Curettes, Cataract Spoons, Lens Scoops  
 Cucharillas para chalazión y para catarata, Asas para catarata  
 Cuillers à chalazion et à cataracte, Anses à cataracte  
 Cucchiari per calazio, Cucchiari per cataratta, Anse per cataratta



**HEBRA**  
 13,0 cm/5"  
 KP 417/20      KP  
 417/25  
 Ø 2,0 mm      Ø 2,5 mm



**GRAEFE**  
 KP 425/14  
 13,5 cm/5<sup>1</sup>/<sub>4</sub>"



**DAVIEL**  
 KP 427/12  
 12,0 cm/4<sup>3</sup>/<sub>4</sub>"  
 3 x 14 mm



**SNELLEN**  
 KP 440/13  
 13,0 cm/5"



**ARLT**  
 KP 442/13  
 13,0 cm/5"



**LEWIS**  
 13,0 cm/5"  
 KP 443/01      KP 443/02  
 4,0 mm      4,7 mm



**NEW ORLEANS**  
 KP 450/13  
 13,0 cm/5"

Positionsspatel, Linsenkerntspatel  
 Lens Spatulas, Nucleus Spatulas  
 Espátulas para manipular, Espátulas para núcleo cristalino  
 Spatules pour manipuler, Spatules pour noyau  
 Spatole per manipolare, Spatole per nucleo cristallino

AA

AB

AC

AD

AE

AK

AR

KA

KM

KO

KP

XR



**JAFFE**  
 KP 470/12  
 12,0 cm/ 4<sup>3</sup>/<sub>4</sub>"  
 0,5 mm



**OBSTBAUM**  
 KP 471/12  
 12,0 cm/ 4<sup>3</sup>/<sub>4</sub>"  
 0,25 mm



1/11



**HIRSCHMANN**  
 KP 472/13  
 12,5 cm/5"



**MOD. DORTMUND**  
 KP 478/12  
 12,0 cm/ 4<sup>3</sup>/<sub>4</sub>"  
 0,6 x 12 mm

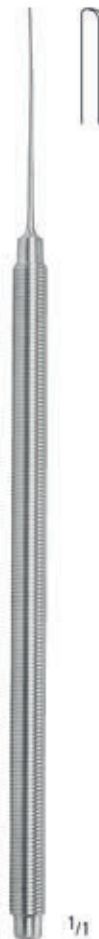

1/11

**KNOLLE**  
 KP 480/13  
 12,5 cm/5"

**TITANIUM**



**LIPPMAN**  
 KP 481/12  
 12,0 cm/ 4<sup>3</sup>/<sub>4</sub>"



1/11

Zyklodialysespatel  
 Cyclodialysis Spatulas  
 Espátulas para ciclodialisis  
 Spatules à cyclodialyse  
 Spatole per ciclodialisi

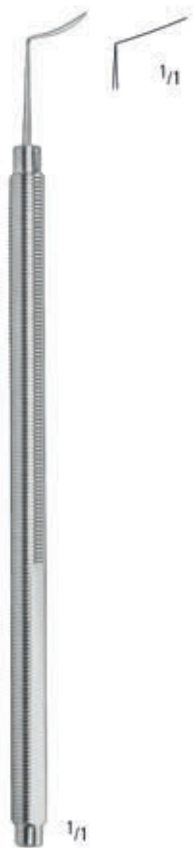

**CASTROVIEJO-BARRAQUER**  
 KP 485/11  
 11,0 cm/4 1/2"  
 0,5 x 10 mm

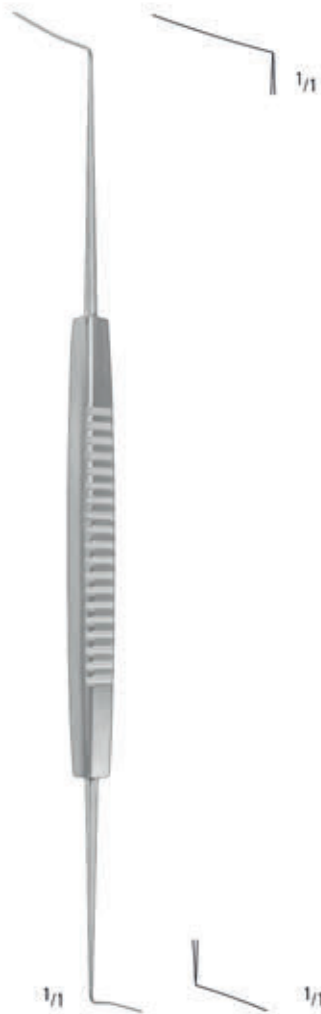

**CASTROVIEJO**  
 KP 487/14  
 13,5 cm/5 1/4"  
 0,5 x 10/16 mm

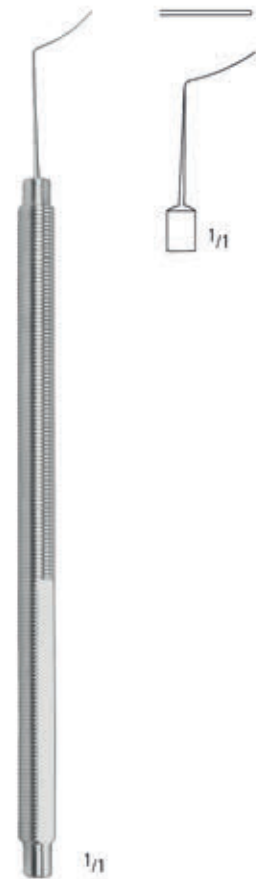

**BARRAQUER-FINO**  
 KP 489/12  
 11,5 cm/4 1/2"  
 0,25 x 12 mm

Irisspatel  
Iris Spatulas  
Espátulas para iris  
Spatules à iris  
Spatole per l'iride

AA

AB

AC

AD

## TITANIUM

AE

AK

AR

KA

KM

KO

KP

XR



biegsam  
malleable  
maleable  
malléable  
malleabile

**WECKER**  
KP 495/13  
13,0 cm/5"  
2 mm

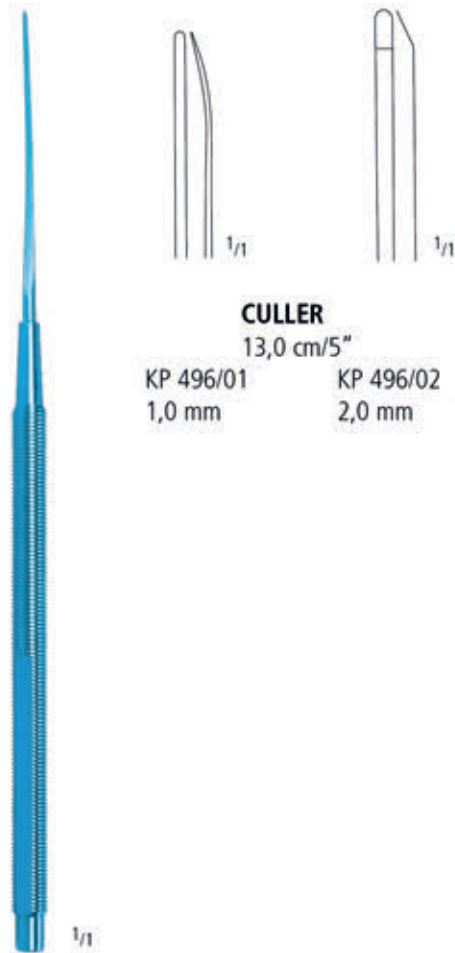

### CULLER

13,0 cm/5"

KP 496/01  
1,0 mm

KP 496/02  
2,0 mm

Markierinstrumente optisches Zentrum, Radial- und Axialmarkierinstrumente  
 Optical Zone Markers, Radial and Axis Markers  
 Marcadores para centro óptico, Marcadores radiales y axiales  
 Marqueurs pour centre optique, Marqueurs radiales et axiales  
 Marcatori ottici, Marcatori radiali e assiali

## TITANIUM

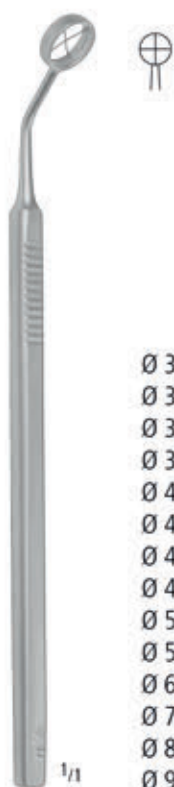

- Ø 3,00 mm KP 500/30
- Ø 3,25 mm KP 500/32
- Ø 3,50 mm KP 500/35
- Ø 3,75 mm KP 500/37
- Ø 4,00 mm KP 500/40
- Ø 4,25 mm KP 500/42
- Ø 4,50 mm KP 500/45
- Ø 4,75 mm KP 500/47
- Ø 5,00 mm KP 500/50
- Ø 5,50 mm KP 500/55
- Ø 6,00 mm KP 500/60
- Ø 7,00 mm KP 500/70
- Ø 8,00 mm KP 500/80
- Ø 9,00 mm KP 500/90

**HOFFER**  
10,0 cm/4"



- 8 Klingen
- 8 blades
- 8 hojas
- 8 lames
- 8 lame

**ANIS**  
KP 505/12  
12,0 cm/4<sup>3</sup>/<sub>4</sub>"  
Ø 4 mm/12,5 mm

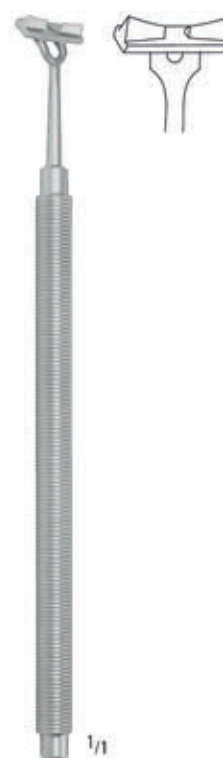

**BORES**  
KP 508/10  
10,0 cm/4"



**GRANDON**  
KP 510/11  
11,0 cm/4<sup>1</sup>/<sub>2</sub>"  
3 mm

Hornhautmarkierinstrumente  
 Corneal Markers  
 Marcadores corneales  
 Marqueurs cornéens  
 Marcatori corneali

AA

AB

AC

AD

AE

AK

AR

KA

KM

KO

KP

XR

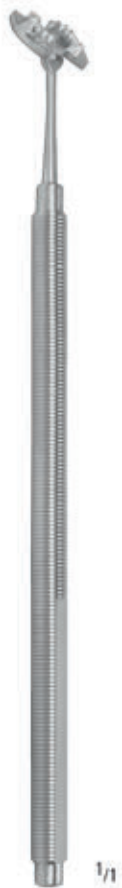

1/1

**LINDSTROM**  
 KP 515/12  
 12,0 cm/4<sup>3</sup>/<sub>4</sub>"  
 7 mm



1/1

**LU**  
 KP 516/11  
 10,5 cm/4<sup>1</sup>/<sub>4</sub>"  
 Ø 8,5 mm

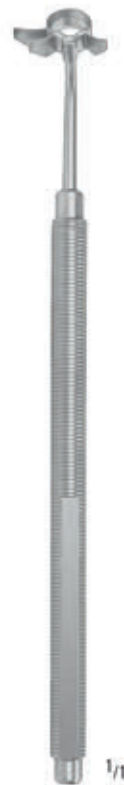

1/1

KP 518/10  
 10,0 cm/4"

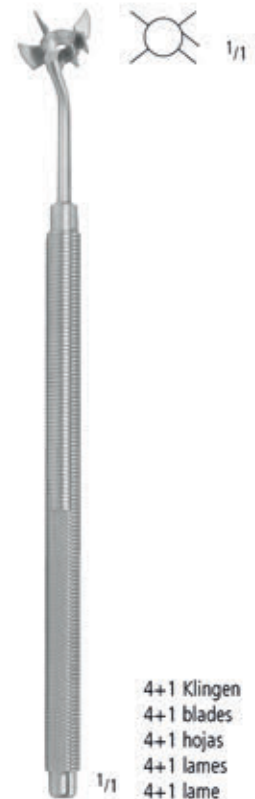

1/1

4+1 Klengen  
 4+1 blades  
 4+1 hojas  
 4+1 lames  
 4+1 lame

KP 519/10  
 10,0 cm/4"  
 Ø 5 + 11 mm

Hornhaut-, Limbus Inzisions-, Nahtplatzierungsmarkierinstrumente  
 Corneal Markers, Limbal Incision Rulers, Suture Placement Markers  
 Marcadores corneales, para incisión limbal y para suturas  
 Marqueurs pour kéroplastie, pour incision limbique et à sutures  
 Marcatori corneali, per incisione in limbo e per sutura

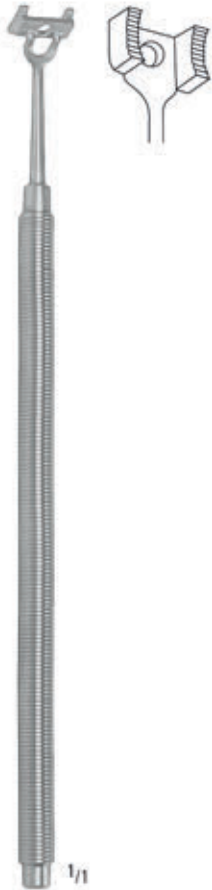

**THORNTON**  
 KP 523/12  
 12,0 cm/4<sup>3</sup>/<sub>4</sub>"  
 6-8 mm / 0,5-5,0 mm

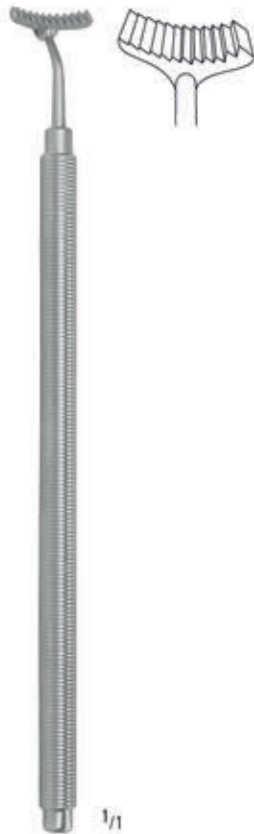

**THORNTON**  
 KP 530/11  
 11,0 cm/4<sup>1</sup>/<sub>2</sub>"  
 1-10 mm



**ANIS**  
 KP 535/12  
 12,0 cm/4<sup>3</sup>/<sub>4</sub>"



**GONNIN**  
 KP 540/13  
 13,0 cm/5"  
 11-23 mm / 1 mm



Tonometer, Keratometer  
 Tonometers, Keratometer  
 Tonómetros, Queratómetro  
 Tonomètres, Kératomètre  
 Tonometri, Cheratometro



**SCHIOETZ**  
 13,0 cm/5"

gerade Skala  
 straight scale  
 graduado recto  
 échelle droite  
 scala retta

schräge Skala  
 inclined scale  
 graduado inclinado  
 échelle oblique  
 scala inclinata

Spezifikation Nr. 3  
 Specification No. 3  
 Especificación No. 3  
 Spécification No. 3  
 Specifica No. 3

KP 543/00

Spezifikation Nr. 5, geeicht  
 Specification No. 5, calibrated  
 Especificación No. 5, calibrada  
 Spécification No. 5, calibrée  
 Specifica No. 5, calibrata

KP 542/01

KP 543/01



1/1

**MALONEY**  
 KP 545/02  
 2,0 cm/3/4"

AA

AB

AC

AD

AE

AK

AR

KA

KM

KO

KP

XR

Messinstrumente, Tiefenlehre, Fixierringe  
 Measuring Instruments, Depth Gauge, Fixation Rings  
 Instrumentos de medición, Medidor de profundidad, Anillos de fijación  
 Instruments de mesure, Jauge de profondeur, Anneaux de fixation  
 Strumenti per la misurazione, Misuratori di profondità, Anelli di fissazione



**MENDEZ**  
 KP 547/11  
 11,0 cm/4 1/2"  
 C 10°, 0 -180°



**DEITZ**  
 9,5 cm/3 3/4"  
 KP 548/50      KP 548/55  
 0,50 mm      0,55 mm

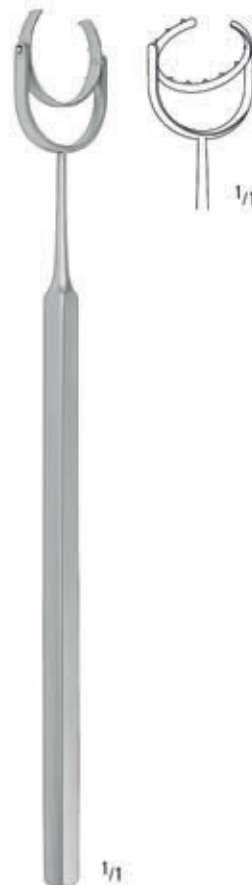

**THORNTON**  
 KP 550/12  
 12,0 cm/4 3/4"  
 Ø 13 mm



**BONN**  
 KP 555/11  
 10,5 cm/4 1/4"

Hornhautbohrer und -trephinen  
 Corneal Burrs and Trephines  
 Fresas y trépanos corneales  
 Trépanos kératoplastie  
 Trepani corneali

AA

AB

AC

AD

AE

AK

AR

KA

KM

KO

KP

XR



1/1

**CASTROVIEJO**  
 5,0 cm/2"

mm Ø

5,0	KP 600/50
5,5	KP 600/55
6,0	KP 600/60
6,5	KP 600/65
7,0	KP 600/70
7,5	KP 600/75
8,0	KP 600/80
9,0	KP 600/90



1/1

**FRANCESCHETTI**  
 7,5 cm/3"

mm Ø

7,0	KP 603/70
7,1	KP 603/71
8,0	KP 603/80
8,1	KP 603/81



1/1

**MARTIN**  
 4,0 cm/1 1/2"

mm Ø

5,0	KP 605/50
5,5	KP 605/55
6,0	KP 605/60
6,5	KP 605/65
6,7	KP 605/67
7,0	KP 605/70
7,2	KP 605/72
7,5	KP 605/75

mm Ø

7,7	KP 605/77
8,0	KP 605/80
8,2	KP 605/82
8,5	KP 605/85
8,7	KP 605/87
9,0	KP 605/90
9,5	KP 605/95

Hornhautbohrer und -trephinen  
 Corneal Burrs and Trephines  
 Fresas y trépanos corneales  
 Trépanos kératoplastie  
 Trepani corneali



**ELLIOT**  
 KP 611/00  
 3,0 cm/1 1/4"



**ELLIOT**  
 KP 612/10  
 Ø 1,0 mm



**ELLIOT**  
 KP 612/15    KP 612/20  
 Ø 1,5 mm    Ø 2,0 mm

**ELLIOT SET**

- KP 610/00 = KP 611/00
- KP 612/10
- KP 612/15
- KP 612/20

mit Etui  
 with case  
 con estuche  
 avec boîte  
 con scatola



mit 6 Fräsen  
 with 6 burrs  
 con 6 fresas  
 avec 6 fraises  
 con 6 fresas

**STORZ**  
 KP 620/08  
 8,0 cm/3 1/4"

Rostringfräse, Fixierringe,  
Rust Ring Remover, Scleral Fixation Rings  
Anillo removedor de óxido, Anillos de fijación  
Fraise pour enlever la rouille, Anneaux de fixation  
Fresa corneale, Anelli di fissazione



**RUST RING  
REMOVER SET**  
KP 630/00  
12,5 cm/5"



KP 631/00  
6 Fräsen  
6 burrs  
6 fresas  
6 fraises  
6 fresas

KP 632/00  
Batterie, 2 Stück  
Battery, 2 pieces  
batería, 2 piezas  
piles, 2 pièces  
pile, 2 pezzi

KP 630/00 = KP 631/00 + KP 632/00



**FLIERINGA**

mm Ø	
14	KP 640/14
16	KP 640/16
18	KP 640/18
20	KP 640/20
22	KP 640/22
24	KP 640/24

AA  
AB  
AC  
AD  
AE  
AK  
AR  
KA  
KM  
KO  
KP  
XR

Vorderkammerspülkanülen, Silikonball, Verbindung, Spülkanülen  
 Anterior Chamber Irrigation Cannula, Silicon Ball, Connection, Irrigation Cannulas  
 Cánulas de irrigación para cámara anterior, Pelota de silicona, Conector, Cánulas para irrigación  
 Canules à lavage pour chambre antérieure, Balle de silicone, Raccord, Canules irrigatrices  
 Cannule d'irrigazione per camera anteriore, Palla di silicone, Raccordo, Cannule d'irrigazione

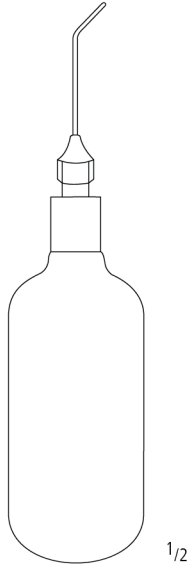

**BISHOP-HARMON**  
 KP 700/00

Set komplett  
 Set complete  
 Juego completo  
 Jeu complet  
 Set completo

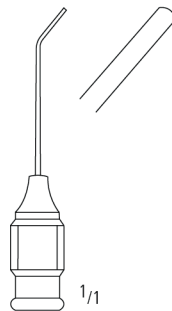

**BISHOP-HARMON**  
 KP 701/19  
 4,0 cm/1 1/2"  
 19G

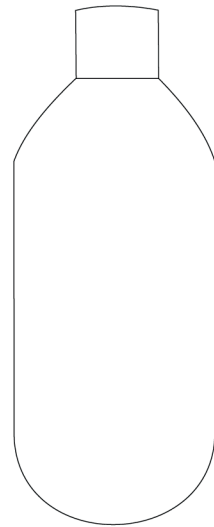

KP 702/00  
 7,5 cm/2 3/4"

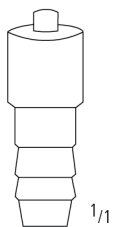

**LUER-LOCK**  
 KP 703/00  
 3,0 cm/1 1/4"

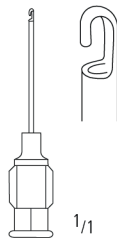

**McINTYRE**  
 KP 704/23  
 3,0 cm/1 1/4"  
 23G

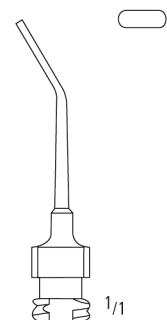

**MODELL BONN**  
 4,0 cm/1 1/2"  
 KP 705/19      KP 705/20  
 19G                      20G

Vorderkammer-, Saug- und Spülkanülen, Luftkanülen  
 Anterior Chamber, Irrigation and Aspiration Cannulas, Air Injection Cannulas  
 Cánulas para cámara anterior, irrigación y aspiración, Cánulas para inyectar aire  
 Canules à chambre antérieure, irrigatrices et pour aspiration, Canules à injection d'air  
 Cannule per camera anteriore, d'irrigazione e d'aspirazione, Cannule per iniettare aria

AA

AB

AC

AD

AE

AK

AR

KA

KM

KO

KP

XR

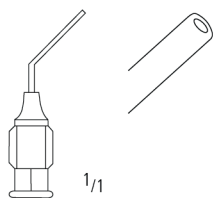

**McINTYRE**

2,5 cm/1"

KP 712/27 KP 712/30  
 27G 30G

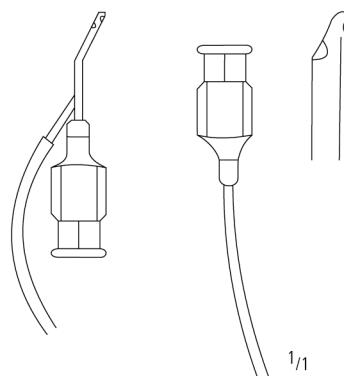

**SIMCOE**

KP 720/23  
 3,0 cm/1 1/4"

25/23G

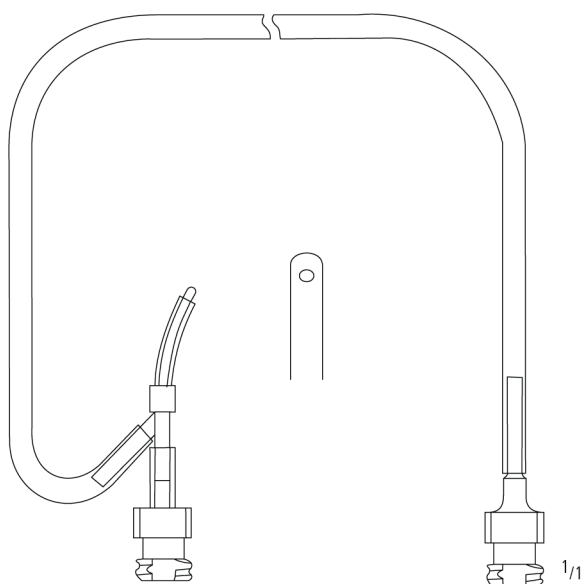

**FRIEDBURG**

KP 721/00

4,0 cm/1 1/2"

3,0 cm/1 1/4"

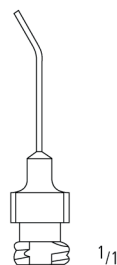

3,5 cm/1 1/2"

KP 730/27 KP 730/30  
 27G 30G

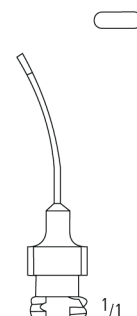

**SAUTTER**

KP 731/27  
 3,5 cm/1 1/2"

27G

Tränenwegkanülen, Kortex Extraktor  
 Lacrimal Cannulas, Cortex Extractor  
 Cánulas lacrimales, Extractor para corteza  
 Canules à voies lacrymales, Extracteur de cortex  
 Cannules per vie lacrimali, Estrattore per capsula

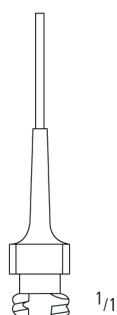

**ANEL**  
 KP 740/23  
 4,0 cm/1 1/2"  
 23G

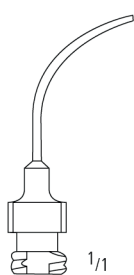

KP 741/23  
 3,5 cm/1 1/2"  
 23G

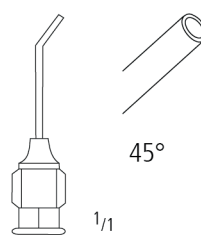

**GILLS-WELSH**  
 KP 745/25  
 3,0 cm/1 1/4"  
 25G

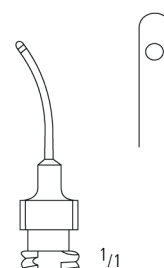

**SIMCOE**  
 KP 746/23  
 3,0 cm/1 1/4"  
 23G

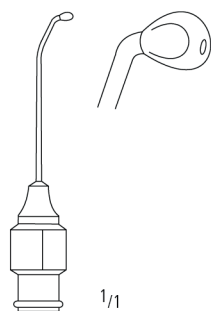

**WELSH**  
 KP 747/00  
 4,0 cm/1 1/2"  
 25G

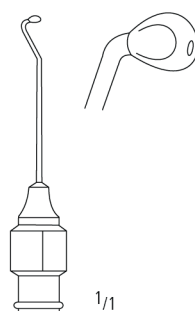

**WELSH**  
 KP 747/01  
 4,0 cm/1 1/2"  
 25G

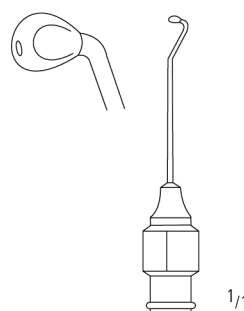

**WELSH**  
 KP 747/02  
 4,0 cm/1 1/2"  
 25G



Linsenschlinge und Linsenkerenschlinge mit Spülung, Injektionskanüle  
 Lens Loop and Lens Nucleus Loop with Irrigation, Injection Cannula  
 Asas para cristalino y Cánula para núcleo con irrigación, Cánula para inyección  
 Anses à cristallin et Canula du noyau avec irrigation, Canule à injection  
 Anse per cristallino con irrigazione, Irrigatore per lenti intraoculari, Cannula per lavaggio

AA  
AB  
AC  
AD  
AE  
AK  
AR  
KA  
KM  
KO  
KP  
XR

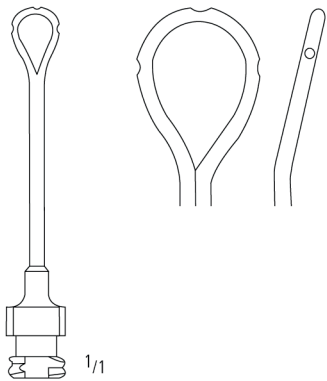

**KNOLLE-PEARCE**  
 KP 755/23  
 5,0 cm/2"  
 23G

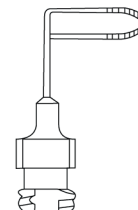
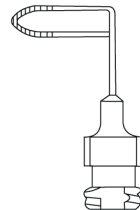
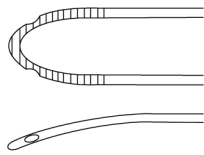

**SIMCOE**  
 3,0 cm/1 1/4"  
 KP 756/01  
 25G  
 KP 756/02  
 25G

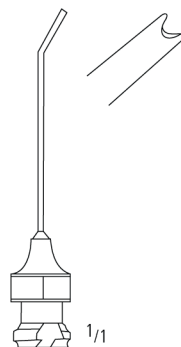

KP 760/21  
 4,5 cm/2"  
 21G

Kapselpolierer, Kapselpeile, Kapselsauger  
 Capsule Polisher, Capsule Scraper, Erisiphake  
 Pulidor para cápsula, Erisiphake  
 Canule gratteuse, Erisiphaque capsulaire  
 Levigatore corneale, Aspiratore capsulare

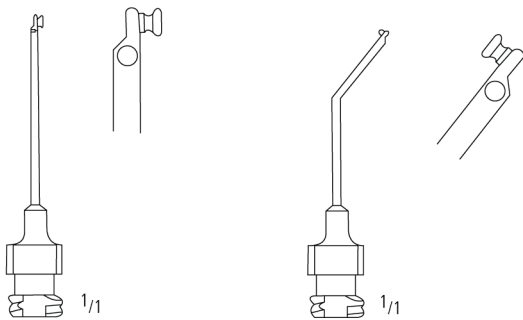

**GRAETHER**  
 4,0 cm/1 1/2"

KP 763/01  
 23G

KP 763/02  
 23G

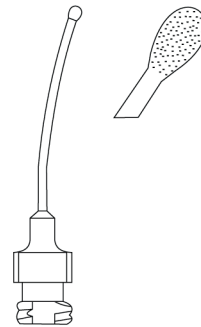

**JENSEN**  
 KP 767/27  
 4,5 cm/2"  
 27G

KP 768/23  
 23G

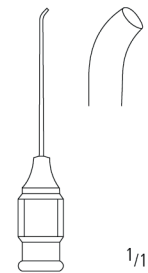

**KNOLLE**  
 3,5 cm/1 1/2"

KP 768/30  
 30G

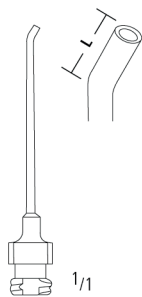

**KRATZ**  
 3,5 cm/1 1/2"

KP 772/01  
 23G  
 L = 1 mm

KP 772/02  
 23G  
 L = 2 mm

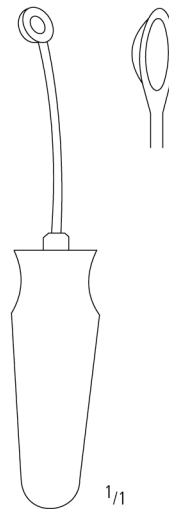

**BELL**  
 KP 775/00  
 6,5 cm/2 1/2"

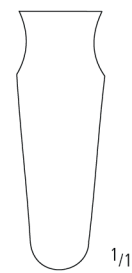

**BELL**  
 KP 775/01

Zyklodialysen-, Alpha-Chymotrypsin- und Zystotomkanüle  
 Cyclodialysis-, Alpha-Chymotrypsin- and Cystotome Cannula  
 Cánula para ciclodialísis, Alpha-Chymotrypsin y cistótomo  
 Canule pour cyclodialyse, à injection Alpha-Chimo-Trypsine et cystotome  
 Cannule per ciclodialisi, per alfa-chimotripsina e per cistotomi

AA

AB

AC

AD

AE

AK

AR

KA

KM

KO

KP

XR



**KELMAN**  
4,0 cm//1 1/2"

KP 780/01  
19G

rechts  
right  
derecho  
droit  
destro

KP 780/02  
19G

links  
left  
izquierda  
gauche  
sinistro



**TROUTMAN**

KP 783/25  
4,5 cm//2"  
25G

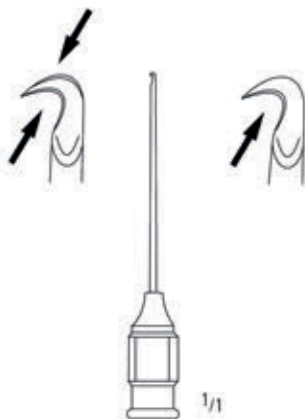

**KELMAN**  
4,5 cm//2"

KP 786/00  
22G

KP 786/01  
22G

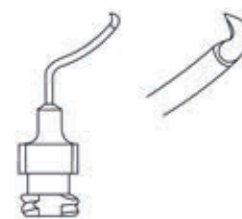

**KRATZ**

KP 788/22  
3,0 cm//1 1/4"  
22G

Augennadeln  
Eye Needles  
Agujas oculares  
Aiguilles ophtalmiques  
Aghi oftalmichi

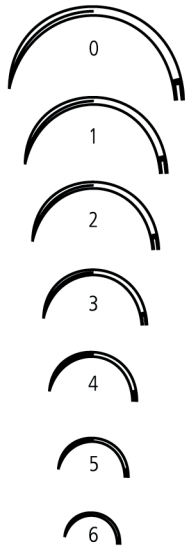

**OG**  
gebogen 1/2 Kreis  
curved 1/2 circle  
curvas 1/2 círculo  
coubes 1/2 cercle  
curvi 1/2 circolo

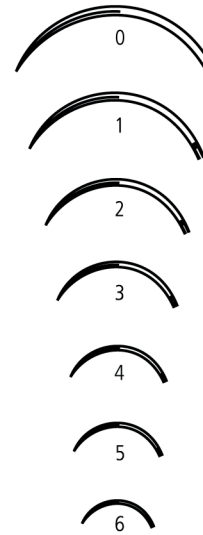

**OB**  
gebogen 3/8 Kreis  
curved 3/8 circle  
curvas 3/8 círculo  
coubes 3/8 cercle  
curvi 3/8 circolo



gewöhnliches Ohr  
regular eye  
ojo ordinario  
chas régulier  
cruna ordinaria

- KP 950/00
- KP 950/01
- KP 950/02
- KP 950/03
- KP 950/04
- KP 950/05
- KP 950/06



Federöhr  
spring eye  
ojo de resorte  
chas à ressort  
cruna a molla

- KP 951/00
- KP 951/01
- KP 951/02
- KP 951/03
- KP 951/04
- KP 951/05
- KP 951/06



gewöhnliches Ohr  
regular eye  
ojo ordinario  
chas régulier  
cruna ordinaria

- KP 952/00
- KP 952/01
- KP 952/02
- KP 952/03
- KP 952/04
- KP 952/05
- KP 952/06

- FIG. 0**
- FIG. 1**
- FIG. 2**
- FIG. 3**
- FIG. 4**
- FIG. 5**
- FIG. 6**



Federöhr  
spring eye  
ojo de resorte  
chas à ressort  
cruna a molla

- KP 953/00
- KP 953/01
- KP 953/02
- KP 953/03
- KP 953/04
- KP 953/05
- KP 953/06

Verkaufseinheit 1 Dutzend  
unit for sale 1 dozen  
unidad de venta 1 docena  
unité d' 1 douzaine  
unità di vendita 1 dozzina

Augenklappen, Pinsel  
 Eye Patches, Brushes  
 Protectores de ojos, Pincel  
 Bandeaux pour les yeux, Pinceau  
 Benda di protezione per gli occhi, Pennello



KP 955/01



KP 955/02



KP 956/00



**BARRAQUER**  
 KP 959/00

AA

AB

AC

AD

AE

AK

AR

KA

KM

KO

**KP**

XR



HF-ZUBEHÖR  
HF-ACCESSORIES  
AF-ACCESORIOS  
HF-ACCESSOIRES  
AF-ACCESSORI

**XR**

**nopa**<sup>®</sup> instruments







Anschlußkabel, Bi-Koagulations-Pinzetten  
 Connection Cords, Bi-Coagulation-Forceps  
 Cables de conexión, Pinzas para Coagulación  
 Câbles de raccordement, Pincas pour Bi-Coagulation  
 Cavi da connessione, Pinze per la Bi-Coagulazione

AA

AB

AC

AD

AE

AK

AR

KA

KM

KO

KP

XR

bipolar



**MARTIN / BERCHTHOLD**

XR 830/03

XR 830/05

300 cm

500 cm

bipolar



**ERBE/SELECT**

XR 832/03

XR 832/05

D=0,5 mm

E=Nadel



11,0 cm/4 <sup>1</sup> / <sub>3</sub> "	XR 898/11 D	XR 899/11 D
11,0 cm/4 <sup>1</sup> / <sub>3</sub> "	XR 898/11 E	XR 899/11 E

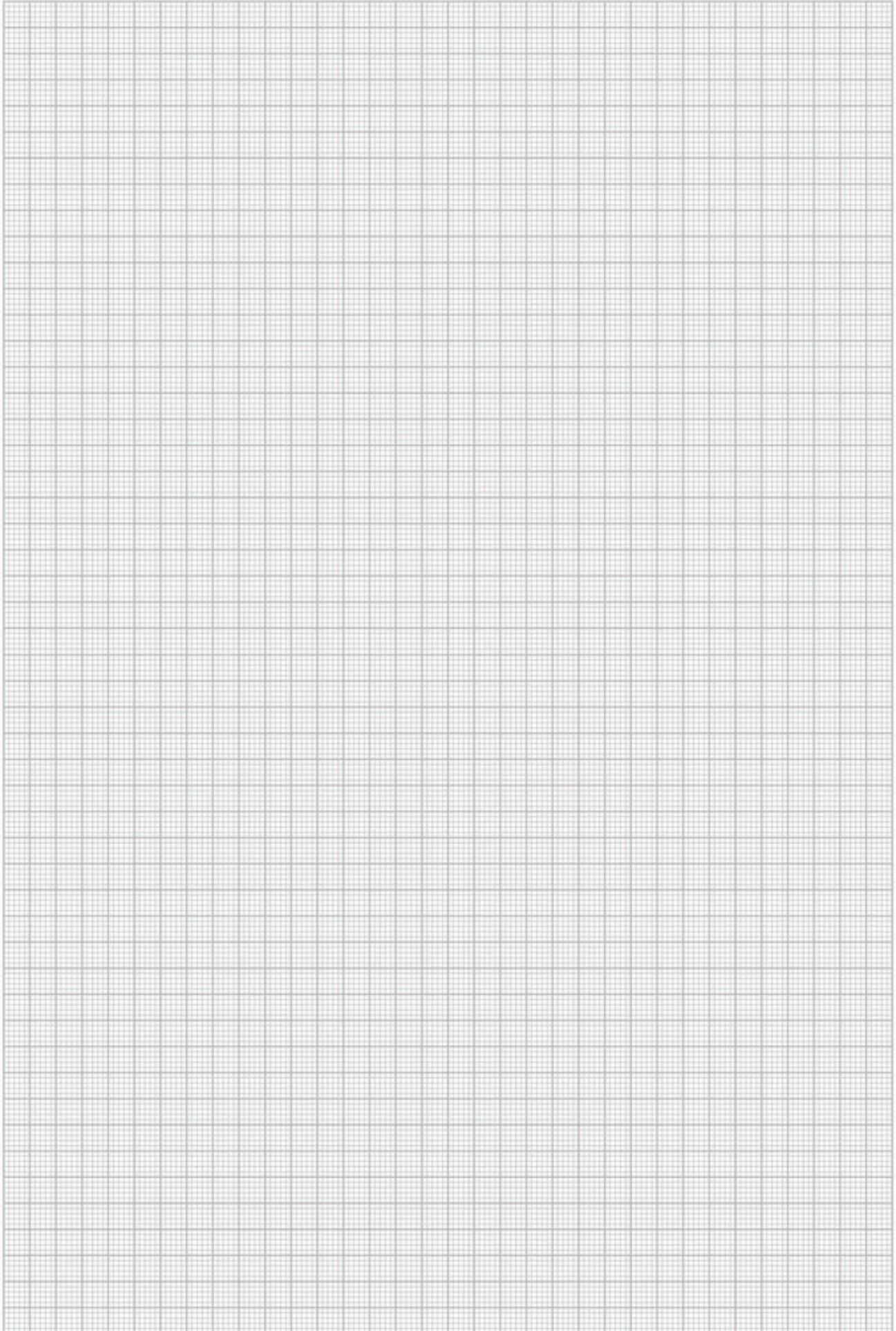

# Inhaltsverzeichnis

	Seite		Seite
<b>A</b>			
<b>ADSON</b> , Anatomische Pinzetten	82	<b>BOWMAN</b> , Lidsperrer	166
<b>ADSON</b> , Chirurgische Pinzetten	82	<b>BOWMAN</b> , Tränenwegsonden	163
<b>ADSON, MICRO</b> Anatomische Pinzetten	82	<b>BROWN-ADSON</b> , Chirurgische Pinzetten	82
<b>ADSON, MICRO</b> Chirurgische Pinzetten	82	Bulldogklemmen	77
<b>ADSON-BROWN</b> , Chirurgische Pinzetten	82	<b>BUNGE</b> , Exenterationslöffel	184
<b>ADVENTITIA</b> , Mikroscheren	114, 116	<b>BUNNKATU</b> , Linsenkernteiler und -trenner	159
<b>AGRICOLA</b> , Tränensackspreizer	170	<b>BURCH</b> , Fixiergabel	155
Alpha-Chymotrypsin-Kanüle	203	<b>BURCH-LESTER</b> , Lidsperrer	168
Anatomische Pinzetten	82	<b>C</b>	
<b>ANEL</b> , Tränenwegkanülen	200	<b>CASTROVIEJO</b> , Fixierpinzetten	90
<b>ANIS</b> , Nahtplatzierungsmarkeur	192	<b>CASTROVIEJO</b> , Hornhautscheren	109, 110
<b>ANIS</b> , Radialmarkeur	190	<b>CASTROVIEJO</b> , Iridektomiescheren	107
Anlegezangen	77	<b>CASTROVIEJO</b> , Kapselpinzetten	88
Anschlußkabel	209	<b>CASTROVIEJO</b> , Keratoplastiktrepän	195
<b>ARLT</b> , Starschlingen	186	<b>CASTROVIEJO</b> , Lidsperrer	167
<b>ARLT-FISCHER</b> , Irispinzetten	85	<b>CASTROVIEJO</b> , Löffel für Hornhauttransfer	185
<b>ARRUGA</b> , Kapselpinzetten	89	<b>CASTROVIEJO</b> , Messzirkel	143
<b>ARRUGA</b> , Mikro-Nadelhalter	132	<b>CASTROVIEJO</b> , Mikro-Nadelhalter	131
<b>ARRUGA</b> , Wundlöffel	171	<b>CASTROVIEJO</b> , Mikro-Nadelhalter mit Hartmetalleinsätzen	127, 128
<b>ARRUGA-KALT</b> , Mikro-Nadelhalter	132	<b>CASTROVIEJO</b> , Mikro-Nadelhalter mit Rundgriff	133
Arterienklemmen	78	<b>CASTROVIEJO</b> , Nahtpinzetten	91
Augenklappen	205	<b>CASTROVIEJO</b> , Tränenkanaldilatatore	165
Augenmagnet mit Fremdkörperschlinge	178	<b>CASTROVIEJO</b> , Zyklodialysenspatel	188
Augennadeln	204	<b>CASTROVIEJO-BARRAQUER</b> , Zyklodialysenspatel	188
Augenscheren	46	<b>CASTROVIEJO-KALT</b> , Mikro-Nadelhalter	132
Axial- und Radialmarkierinstrumente	190	<b>CHADWICK</b> , Augenscheren	104
<b>AYER</b> , Chalazionpinzetten	95	Chalazionlöffel	185, 186
<b>B</b>			
<b>BACKHAUS</b> , Tuchklemmen	79	Chalazionpinzetten	95, 96
<b>BARKAN</b> , Goniotomiemesser	174	Chirurgische Pinzetten	82
<b>BARRAQUER PHAKO</b> , Lidsperrer	166	<b>CHRIS-TROUTMAN</b> , Klingendreher	124
<b>BARRAQUER</b> , Cilienpinzetten	83	Cilienpinzetten	83
<b>BARRAQUER</b> , Lidsperrer	166	<b>CITELLI</b> , Stanzen	154
<b>BARRAQUER</b> , Mikro-Nadelhalter mit Rundgriff	129	<b>CLAYMAN</b> , Linsenkerndreher	158
<b>BARRAQUER</b> , Minischeren	107	<b>CLUB-GOLF</b> , Fremdkörpermeißel	177
<b>BARRAQUER</b> , Vorderkammer-Pinzetten	91	<b>COLIBRI-BARRAQUER</b> , Lidsperrer	166
<b>BARRAQUER-CASTROVIEJO</b> , Zyklodialysenspatel	188	<b>COLLIN</b> , Skalpgriffe	121
<b>BARRAQUER-COLIBRI</b> , Lidsperrer	166	<b>COOK</b> , Lidsperrer	168
<b>BARRAQUER-FINO</b> , Zyklodialysenspatel	188	<b>CORCELLE</b> , Lidsperrer	166
<b>BARRAQUER-KATZIN (COLIBRI)</b> , Irispinzetten	87, 88	<b>CULLER</b> , Irisspatel	189
<b>BARRAQUER-KATZIN</b> , Hornhautscheren	111	<b>CUSHING</b> , feine Wundhaken	149
<b>BARRAQUER-KRATZ</b> , Lidsperrer	166	<b>D</b>	
<b>BARRAQUER-TROUTMAN</b> , Mikro-Nadelhalter mit Rundgriff	129	<b>DAVIEL</b> , Starlöffel	186
<b>BECHERT</b> , Linsenkerndreher	158	<b>DAVIS</b> , Fremdkörpermeißel	177
<b>BECHERT-JAFFE</b> , Linsenkerndreher	158	<b>DEITZ</b> , Tiefenlehre	194
<b>BEER</b> , Cilienpinzetten	83	Depressor, Sklera-	172
<b>BELL</b> , Kapselsauger	202	<b>DERF</b> , Nadelhalter	126
<b>BERENS</b> , Muskelklemmen	95	<b>DERF</b> , TUC Nadelhalter	126
<b>BERKE</b> , Ptosispinzetten	96	<b>DESMARRES</b> , Chalazionpinzetten	95
Bi-Koagulations Pinzetten	209	<b>DESMARRES</b> , feine Wundhaken	155
<b>BINKHORST</b> , Kapselpinzetten	89	Diamantmesser	180-181
<b>BISHOP-HARMON</b> , Irispinzetten	87	<b>DIEFFENBACH</b> , Bulldogklemmen	77
<b>BISHOP-HARMON</b> , Vorderkammerspülkanülen	198	<b>DIETHRICH</b> , Mikro-Nadelhalter mit Hartmetalleinsätzen	128
<b>BLASCOVICS</b> , Muskelpinzetten	94	Dilatatore, Tränenkanal-	164, 165
<b>BÖHLER</b> , Hohlmeißelzangen	151	<b>DISSECTION</b> , Mikroscheren	114, 116
<b>BONACCOLTO</b> , Strabismuspinzetten	92	Diszisionsmesser	173
<b>BONN MOD.</b> , Nahtpinzetten	92	<b>DIX</b> , Fremdkörperinstrumente	178
<b>BONN</b> , feine Scheren	101	<b>DORTMUND</b> , Phakospatel	187
<b>BONN</b> , Fixationsring	194	<b>DOUGLAS</b> , Cilienpinzetten	83
<b>BONN</b> , Irishäkchen	156	<b>DRYSDALE</b> , Linsenkerndreher	159
<b>BONN</b> , Irispinzetten	86, 87	<b>E</b>	
<b>BONN</b> , Skleramesser	174	<b>ELLIOT</b> , Skleratrepan	196
<b>BONN</b> , Spülkanülen	198	<b>ELLIOT</b> , Trepanhandgriff	196
<b>BORES</b> , Axialmarkeur	190	<b>ELLIS</b> , Fremdkörpermeißel	177
		<b>ELSCHNIG</b> , Fixierpinzetten	90
		Entropiumpinzetten	95

	Seite		Seite
Enukleationslöffel	184	Hammer	151
<b>ERHARDT</b> , Entropiumpinzetten	95	<b>HARMON-BISHOP</b> , Irispinzetten	87
Exenterationslöffel	184	<b>HARMON-BISHOP</b> , Vorderkammerspülkanülen	198
F		<b>HARMS</b> , Knüpfpinzetten mit Plateau	93
Fadenpinzetten	92, 93	<b>HARMS</b> , Trabekularsonden	165
Fasszangen, Vitrektomie-	183	<b>HARTMANN</b> , Arterienklemmen	78
<b>FAULKNER</b> , Linsenhaltepinzetten	97	<b>HARTMANN-HALLE</b> , Nasenspekula	155
Feine Scheren	101	<b>HEBRA</b> , Chalazionslöffel	186
Feine Wundhaken	147-150	<b>HESS</b> , Irispinzetten	86
<b>FINO-BARRAQUER</b> , Zyklodialysenspatel	188	<b>HESS-GILL</b> , Irispinzetten	88
<b>FISCHER-ARLT</b> , Irispinzetten	85	<b>HIRSCHMANN</b> , IOL Positionsspatel	187
Fixiergabel	155	<b>HIRSCHMANN</b> , Irishäkchen	157
Fixierkrallen	155	<b>HOFFER</b> , Markeur optisches Zentrum	190
Fixierpinzetten	89, 90	Hohlmeißel	155
Fixierringe	194, 195	Hohlmeißelzangen	151
<b>FLIERINGA</b> , Fixierringe	195	<b>HOPKINS-JOHNS</b> , Anlegezangen	77
<b>FOERSTER</b> , Irispinzetten	86	<b>HOPKINS-JOHNS</b> , Bulldogklemmen	77
<b>FRANCESCHETTI</b> , Keratoplastiktrepán	195	Hornhautfräsen	196
<b>FRANCIS</b> , Fremdkörpermeißel	177	Hornhautmarkierinstrumente	191
Fräsen, Hornhaut-	196	Hornhautmesser	173
Fräsen, Rostring	195	Hornhautschaber	173
<b>FRAZIER</b> , feine Wundhaken	147	Hornhautscheren	87-90
Fremdkörperinstrumente	178	Hornhauttrephinen	195, 196
Fremdkörpermeißel	176-178	I	
Fremdkörpernadeln	176-178	Injektionskanülen	201
<b>FRENCH-EYE/Ryder</b> , TUC Nadelhalter	126	Inzisionsmarkierinstrumente	192
<b>FRIEDBURG</b> , Spül-Saugkanülen	199	<b>IOL</b> Manipulator und Irisretractor	161
<b>FRIEDMAN</b> , Hohlmeißelzangen	151	<b>IOL</b> Positionshäkchen	160, 161
<b>FUCHS-GILL</b> , Irispinzetten	88	Iridektomiescheren	102, 106, 107
G		Irishäkchen	156, 157
<b>GASS</b> , Netzhautablösungshaken	154	Irispinzetten	84-88
<b>GASS</b> , Sklera Marker	172	Irisretractor und <b>IOL</b> Manipulator	161
<b>GILL</b> , Hornhautmesser	173	Irisscheren	102, 103
<b>GILL</b> , Irispinzetten	88	Irisspatel	189
<b>GILL-FUCHS</b> , Irispinzetten	88	J	
<b>GILL-HESS</b> , Irispinzetten	88	<b>JACOBSON</b> , Mikro-Nadelhalter	131
<b>GILLIES</b> , feine Wundhaken	147	<b>JACOBSON</b> , Mikro-Nadelhalter mit Hartmetalleinsätzen	128
<b>GILLS-WELSH</b> , Kapsulotomiescheren	109	<b>JAEGER</b> , Lidplatte	170
<b>GILLS-WELSH</b> , Kortex-Extraktoren	200	<b>JAFFE</b> , Lidhalter	170
Glattstreicher für Lamellarklappe	171	<b>JAFFE</b> , Positionsspatel	187
<b>GOLF-CLUB</b> , Fremdkörpermeißel	177	<b>JAFFE-BECHERT</b> , Linsenkernwender	158
Goniotomiemesser	174	<b>JAFFE-KNOLLE</b> , Irishäkchen	156
<b>GONNIN</b> , Amsler Markeur	192	<b>JAFFE-MALTZMANN</b> , IOL Positionshäkchen	161
<b>GRADLE</b> , Cilienpinzetten	83	<b>JAMESON</b> , Muskelhaken	154
<b>GRAEFE</b> , Augenscheren	103	<b>JAMESON</b> , Muskelpinzetten	94
<b>GRAEFE</b> , feine Wundhaken	154	<b>JAMESON</b> , Schieblehre	143
<b>GRAEFE</b> , Fixierpinzetten	89	<b>JAPAN-TOHOKU</b> , Tuchklemmen	80
<b>GRAEFE</b> , Irispinzetten	84	<b>JENSEN</b> , Kapselpolierer	202
<b>GRAEFE</b> , Schielhaken	154	<b>JOHNS-HOPKINS</b> , Anlegezangen	77
<b>GRAEFE</b> , Starlöffel	186	<b>JOHNS-HOPKINS</b> , Bulldogklemmen	77
<b>GRAEFE</b> , Starmesser	174	<b>JONES</b> , Tuchklemmen	79
<b>GRAEFE</b> , Zystotome	175	K	
<b>GRAETHER</b> , Kragenknoepfkanülen	202	<b>KALT</b> , Mikro-Nadelhalter	132
<b>GRANDON</b> , T-Inzision's Markeur	190	<b>KALT</b> , Mikro-Nadelhalter mit Hartmetalleinsätzen	128
<b>GREEN</b> , Fixierpinzetten	89	<b>KALT-ARRUGA</b> , Mikro-Nadelhalter	132
<b>GREEN</b> , Muskelhaken	154	<b>KALT-CASTROVIEJO</b> , Mikro-Nadelhalter	132
Griffe, Skalpell-	121, 122	Kanüle, Alpha-Chymotrypsin-	203
<b>GUTHRIE</b> , feine Wundhaken	155	Kanülen, Injektions-	201
H		Kanülen, Spül-	198
Häkchen, Iris-	156, 157	Kanülen, Vorderkammer-	199
Haken, Muskel-	154	Kanülen, Zyklodialysen-	203
Haken, Netzhautablösungs-	154	Kanülen, Zystotom-	203
Haken, Phako-	159	Kapselneifen	202
Haken, Schiel-	154	Kapselpinzetten	88, 89
<b>HALLE-HARTMANN</b> , Nasenspekula	155	Kapselpolierer	202
<b>HALSEY</b> , Nadelhalter	126	Kapselsauger	202
<b>HALSEY</b> , TUC Nadelhalter	126	Kapsulorhexispinzetten	97
<b>HALSTED-MOSQUITO</b> , Arterienklemmen	78	Kapsulotomiescheren	109
<b>HAMBURG</b> , Luftlanzen	175	<b>KATZIN</b> , Hornhautscheren	110

	Seite		Seite
<b>KATZIN-BARRAQUER (COLIBRI)</b> , Irispinzetten	87, 88	Manipulatoren, Linsenkern-	158, 159
<b>KATZIN-BARRAQUER</b> , Hornhautscheren	111	Marker, Sklera-	172
Keilbeinstanzen	155	Markeure, div.	190-192
<b>KELMAN</b> , Zyklodialysenkanülen	203	Markierinstrumente optisches Zentrum	190
<b>KELMAN</b> , Zystotomkanülen	203	<b>MARTIN</b> , Keratoplastiktrepán	195
<b>KELMAN-McPHERSON</b> , Nahtpinzetten	92	Maßstab	143
Keratometer	193	<b>MAUMENEE-PARK</b> , Lidsperrerr	167
Keratoplastikmesser	175	Mc <b>DONALD</b> , Kapsulorhexispinzetten	97
<b>KERRISON</b> , Keilbeinstanzen	155	Mc <b>INTYRE</b> , Spülkanülen	198
<b>KILNER</b> , feine Wundhaken	147	Mc <b>INTYRE</b> , Vorderkammerkanülen	199
<b>KIRBY</b> , Irispinzetten	87	Mc <b>PERSON</b> , Knüpfpinzetten	91
<b>KLEINERT-KUTZ</b> , feine Wundhaken	147	Mc <b>PERSON-KELMAN</b> , Nahtpinzetten	92
Klemmen, Arterien-	78	Meißel	151
Klemmen, Bulldog-	77	Meißel, Fremdkörper-	176-178
Klemmen, Tuch-	79, 80	<b>MENDEZ</b> , Grad Messinstrument	194
Klingenbrecher	124	Messer, Diamant-	180-181
<b>KNAPP</b> , feine Wundhaken	155	Messer, Diszisions-	173
<b>KNAPP</b> , Löffel für Hornhauttransfer	185	Messer, Goniotomie-	174
<b>KNOLLE</b> , Hinterkapselpolierer	202	Messer, Hornhaut-	173
<b>KNOLLE</b> , Irishäkchen	156	Messer, Keratoplastik-	175
<b>KNOLLE</b> , Linsenkernspatel	187	Messer, Sklera-	174
<b>KNOLLE-JAFFE</b> , Irishäkchen	156	Messer, Star-	174
<b>KNOLLE-PEARCE</b> , Linsenschlingen	201	Messinstrumente	143, 194
Knüpfpinzetten mit Plateau	93	Messzirkel	143
Kortex-Extraktoren	200	<b>MEYHOEFER</b> , Chalazionslöffel	185
<b>KRATZ</b> , Kapselifeile	202	<b>MICRO-ADSON</b> , Anatomische Pinzetten	82
<b>KRATZ</b> , Zystotomkanülen	203	<b>MICRO-ADSON</b> , Chirurgische Pinzetten	82
<b>KRATZ-BARRAQUER</b> , Lidsperrerr	166	Mikro-Nadelhalter	128-133
<b>KUHNT</b> , Hornhautschaber	173	Mikro-Nadelhalter	128-133
<b>KUTZ-KLEINERT</b> , feine Wundhaken	147	Mikro-Nadelhalter mit Hartmetalleinsätzen	127, 128
L		Mikro-Nadelhalter mit Rundgriff	128, 129, 130, 133
<b>LA GRANGE</b> , Augenscheren	104	Mikroscheren	112-118
<b>LAMPERT</b> , Chalazionpinzetten	96	Mikroscheren, Adventitia	114, 116
<b>LANCASTER</b> , Lidsperrerr	168	Mikroscheren, Dissection	114, 116
<b>LASIK</b> , Glattstreicher für Lamellarklappe	171	Mikroscheren, Nerve	116
<b>LESTER</b> , Fixierpinzetten	90	Minischeren	107
<b>LESTER</b> , IOL Positionshäkchen	161	<b>MOD. BONN</b> , feine Scheren	101
<b>LESTER-BURCH</b> , Lidsperrerr	168	<b>MOD. BONN</b> , Irispinzetten	86, 87
<b>LEWICKY</b> , IOL Positionshäkchen	160	<b>MOD. BONN</b> , Nahtpinzetten	92
<b>LEWIS</b> , Starschlingen	186	<b>MOD. BONN</b> , Spülkanülen	198
Lidhalter	170	<b>MOD. DORTMUND</b> , Phakospatel	187
Lidplatte	170	<b>MOD. HAMBURG</b> , Luftlanzen	175
Lidsperrerr	166-169	<b>MOD. TÜBINGEN</b> , Fadenpinzetten	92
<b>LIEBERMAN</b> , Lidsperrerr	169	<b>MOD. TÜBINGEN-VANNAS</b> , Nachstarscheren	108
Ligaturscheren	106	<b>MOLDESTAD</b> , feine Wundhaken	149
Limbusmarkierinstrumente	192	<b>MOORFIELD</b> , Nahtpinzetten	90
<b>LINDSTROM</b> , Hornhautmarkeur	191	<b>MOSQUITO-HALSTED</b> , Arterienklemmen	78
Linsenaltepinzetten	97	<b>MULDOON</b> , Tränenkanaldilatatoren	164
Linsenkernmanipulatoren	158, 159	Muskelhaken	154
Linsenkernschlingen	201	Muskelpinzetten	94, 95
Linsenkernspatel	187	N	
Linsenkernwender	158	Nachstarscheren	108, 109
Linsenschlingen	201	Nadelhalter, Mikro-	128-133
<b>LIPPMAN</b> , Linsenkernspatel	187	Nadelhalter, Mikro mit Hartmetalleinsätzen	127, 128
<b>LITTAUER</b> , Cilienpinzetten	83	Nadeln, Augen-	204
Löffel für Hornhauttransfer	185	Nadeln, Fremdkörper-	176-178
Löffel, Chalazion-	185, 186	<b>NAGAHARA</b> , Phako Chopper Klingen	159
Löffel, Enukeations-	184	Nahtpinzetten	90-93
Löffel, Exenterations-	184	Nahtplazierungsmarkierinstrumente	192
Löffel, Star-	185, 186	Nasenspekula	155
<b>LORNA</b> , Tuchklemmen	80	<b>NERVE</b> , Mikroscheren	116
<b>LU</b> , Hornhautmarkeur Lasik	191	Netzhautablösungshaken	154
<b>LUER</b> , Hohlmeißelzangen	151	<b>NEW ORLEANS</b> , Starschlingen	186
<b>LUER-LOCK</b> , Verbindung	198	<b>NOYES</b> , Iridektomiescheren	106
Luftkanülen	199	<b>NOYES</b> , Mikroscheren	112
Luftlanzen	175	O	
M		<b>OB</b> , Augennadeln	204
<b>MALONEY</b> , Intra-operativer Keratometer	193	<b>OBSTBAUM</b> , Positionsspatel	187
<b>MALTZMANN-JAFFE</b> , IOL Positionshäkchen	161	O' <b>CONNOR</b> , feine Wundhaken	154

	Seite		Seite
<b>OG</b> , Augennadeln	204	Scheren, Mikro-	112-118
Ophthalmoskop	144	Scheren, Mini-	107
Orbitalretraktoren	171	Scheren, Nachstar-	108, 109
Orbitalspatel	171	Scheren, Sehnen-	104, 109
<b>OSHER</b> , Linsenkernmanipulatoren	158	Scheren, Strabismus-	103, 112
P		Scheren, Vitrektomie-	182
<b>PARK-MAUMENEE</b> , Lidsperrer	167	Schieblehre	143
<b>PARTSCH</b> , Hammer	151	Schielhaken	154
<b>PARTSCH</b> , Meißel	151	<b>SCHIOETZ</b> , Tonometer	193
<b>PATON</b> , Mikro-Nadelhalter	132	Schlingen, Linsen-	201
<b>PAUFIQUE</b> , Fadenpinzetten	93	Schlingen, Linsenkern-	201
<b>PAUFIQUE</b> , Keratoplastikmesser	175	<b>SCHOCKET</b> , Sklera Depressoren	172
<b>PEARCE-KNOLLE</b> , Linsenschlingen	201	<b>SCHOTT</b> , Lidsperrer	167
<b>PEERS</b> , Tuchklemmen	80	Sehnenhäkchen	155
<b>PHAKO BARRAQUER</b> , Lidsperrer	166	Sehnscheren	104, 109
Phakohaken	159	Sets	55-64
Pinsel	205	<b>SIMCOE</b> , Kortex-Extraktoren	200
Pinzetten, Bi Koagulations-	209	<b>SIMCOE</b> , Linsenkernschlingen	201
Pinzetten, Chalazion-	95, 96	<b>SIMCOE</b> , Spül-Saugkanülen	199
Pinzetten, Cilien-	83	<b>SINSKEY, IOL</b> Positionshäkchen	160
Pinzetten, Entropium-	95	Skalpellgriffe	121, 122
Pinzetten, Faden-	92, 93	Skalpellklingen	122, 123
Pinzetten, Fixier-	89, 90	Skleradepressoren	172
Pinzetten, Iris-	84-88	Skleramarker	172
Pinzetten, Kapsel-	88, 89	Skleramesser	174
Pinzetten, Kapsulorhexis-	97	<b>SMITH-POTTS</b> , Mikro-Nadelhalter	132
Pinzetten, Knüpf-	93	<b>SMITH-POTTS</b> , Mikro-Nadelhalter mit Hartmetalleinsätzen	128
Pinzetten, Linsenhalte-	97	<b>SNELLEN</b> , Entropiumpinzetten	95
Pinzetten, Muskel-	94, 95	<b>SNELLEN</b> , Starschlingen	186
Pinzetten, Naht-	90-93	Sonden, Pigtail-	165
Pinzetten, Ptosis-	96	Sonden, Trabekular-	165
Pinzetten, Strabismus-	92	Spatel, Iris-	189
Pinzetten, Vorderkammer-	91	Spatel, Linsenkern-	187
<b>PLEY</b> , Lidsperrer	168	Spatel, Phako-	187
Positionshäkchen, <b>IOL</b>	160, 161	Spatel, Positions-	187
Positionsspatel	187	Spatel, Zyklodialysen-	188
<b>POTTS-SMITH</b> , Mikro-Nadelhalter	132	<b>SPENCER</b> , Ligaturscheren	106
<b>POTTS-SMITH</b> , Mikro-Nadelhalter mit Hartmetalleinsätzen	128	Sperrer, Lid-	166-169
<b>PRINCE</b> , Muskelpinzetten	94	Spreizer, Tränensack-	170
Ptosispinzetten	96	Spülkanülen	198
R		<b>ST. MARTIN</b> , Nahtpinzetten	91
Radial- und Axialmarkierinstrumente	190	Stanzen	154
Rasierklingen	124	Starlöffel	185, 186
<b>REILL</b> , Mikro-Nadelhalter mit Rundgriff	130	Starmesser	174
<b>RENTSCH</b> , Irisretraktor und <b>IOL</b> Manipulator	161	Starschlingen	186
<b>RIBBON</b> , Augenscheren	105	<b>STEVENS</b> , Irispinzetten	85
<b>ROEDER</b> , Tuchklemmen	79	<b>STEVENS</b> , Mikro-Nadelhalter	132
<b>ROLLET</b> , feine Wundhaken	155	<b>STEVENS</b> , Sehnenhäkchen	155
<b>ROSEN</b> , Phako-Splitterhäkchen	159	<b>STEVENS</b> , Sehnscheren	104
Rostringfräsen	195	<b>STEVENSON</b> , Tränensackspreizer	170
<b>RUEDEMANN</b> , Tränenkanaldilatatoren	164	<b>STILLE</b> , Fremdkörperinstrumente	178
<b>RYDER/FRENCH-EYE</b> , TUC Nadelhalter	126	<b>STORZ</b> , Hornhautfräsen	196
S		Strabismuspinzetten	92
<b>SATO</b> , Hornhautmesser	173	Strabismusscheren	103, 112
<b>SATTLER</b> , Muskelpinzetten	94	T	
<b>SAUER</b> , Lidsperrer	168	<b>TERSON</b> , Kapselpinzetten	88
<b>SAUTTER</b> , Luftkanülen	199	<b>THORNTON</b> , Doppel-Hornhautmarkeur	192
<b>SAUTTER</b> , Orbitalspatel	171	<b>THORNTON</b> , Fixationsring	194
Schaber, Hornhaut-	173	<b>THORNTON</b> , Limbus Inzisionsmarkeur	192
<b>SCHAEDEL</b> , Tuchklemmen	79	Tiefenlehre	194
<b>SCHEPENS</b> , Orbitalretraktor	171	<b>TOHOKU-JAPAN</b> , Tuchklemmen	80
<b>SCHEPENS</b> , Sklera Depressoren	172	Tonometer	193
Scheren, Augen-	101-105	<b>TOOK</b> , Hornhautmesser	173
Scheren, fein	101	Trabekularsonden	165
Scheren, Hornhaut-	87-90	Tränenkanaldilatatoren	164, 165
Scheren, Iridektomie-	102, 106, 107	Tränenkanalsonden	163
Scheren, Iris-	102, 103	Tränensackspreizer	170
Scheren, Kapsulotomie-	109	Tränenwegkanülen	200
Scheren, Ligatur-	106	<b>TROUTMAN (CORNEAL)</b> , Irispinzetten	88

	Seite	Seite
<b>TROUTMAN</b> , Alpha-Chymotrypsin-Kanülen	203	
<b>TROUTMAN</b> , Hornhautscheren	110	
<b>TROUTMAN</b> , Mikro-Nadelhalter mit Rundgriff	130	
<b>TROUTMAN-BARRAQUER</b> , Mikro-Nadelhalter mit Rundgriff	129	
<b>TROUTMAN-CHRIS</b> , Klingenbrecher	124	
<b>TÜBINGEN MOD.</b> , Fadenpinzetten	92	
Tuchklemmen	79, 80	
<b>TYRELL</b> , Irishäkchen	157	
V		
<b>VANNAS MOD. TÜBINGEN</b> , Nachstarscheren	108	
<b>VANNAS</b> , Nachstarscheren	108	
Vitrektomiefasszangen	183	
Vitrektomieinstrumente	182, 183	
Vitrektomiescheren	182	
Vorderkammerkanülen	199	
Vorderkammerpinzetten	91	
Vorderkammerspülkanülen	198	
W		
<b>WECKER</b> , Iridektomiescheren	106	
<b>WECKER</b> , Irisspatel	189	
<b>WELLS</b> , E nukleationslöffel	184	
<b>WELSH</b> , Kortex-Extraktor	200	
<b>WELSH-GILLS</b> , Kapsulotomiescheren	109	
<b>WELSH-GILLS</b> , Kortex-Extraktor	200	
Wender, Linsenkern-	158	
<b>WEST</b> , Hohlmeißel	155	
<b>WESTCOTT</b> , Sehnenscheren	109	
<b>WESTCOTT</b> , Strabismusscheren	112	
<b>WHEELER</b> , Diszisionsmesser	173	
<b>WILDER</b> , Tränenkanaldilatatore	164	
<b>WILLIAMS</b> , Lidsperrer	166	
<b>WILMER</b> , Augenscheren	103	
<b>WORST</b> , Pigtail Sonden	165	
Wundhaken, fein	147-150	
Wundlöffel	171	
Z		
Zangen, Hohlmeißel-	151	
<b>ZIEGLER</b> , Cilienpinzetten	83	
<b>ZIEGLER</b> , Diszisionsmesser	173	
Zyklodialysenkanülen	203	
Zyklodialysenspatel	188	
Zystotome	175	
Zystotomkanülen	203	





# Index

	Page		Page
A			
<b>ADSON</b> , Dressing Forceps	82	<b>BONN</b> , Tying Forceps with platform	92
<b>ADSON, MICRO</b> Dressing Forceps	82	<b>BORES</b> , Axis Markers	190
<b>ADSON, MICRO</b> Tissue Forceps	82	<b>BOWMAN</b> , Eye Specula	166
<b>ADSON</b> , Tissue Forceps	82	<b>BOWMAN</b> , Lacrimal Probes	163
<b>ADSON-BROWN</b> , Tissue Forceps	82	<b>BROWN-ADSON</b> , Tissue Forceps	82
<b>ADVENTITIA</b> , Micro Scissors	114, 116	Brushes	205
<b>AGRICOLA</b> , Lacrimal Sac Retractors	170	Bulldog Clamps	77
Air Injection Cannulas	199	<b>BUNGE</b> , Exenteration Spoons	184
Alpha-Chymotrypsin Cannulas	203	<b>BUNNKATU</b> , Nucleus Dividing and Separating Hook	159
Amsler Markers	192	<b>BURCH</b> , Fixation Forks	155
<b>ANEL</b> , Lacrimal Cannulas	200	<b>BURCH-LESTER</b> , Eye Specula	168
<b>ANIS</b> , Radial Markers	190	Burrs, Corneal	196
<b>ANIS</b> , Suture Placement Markers	192	C	
Anterior Chamber Cannulas	199	Caliper	143
Anterior Chamber Forceps	91	Cannulas, Air Injection	199
Anterior Chamber Irrigation Cannulas	198	Cannulas, Alpha-Chymotrypsin	203
<b>ARLT</b> , Lens Scoops	186	Cannulas, Anterior Chamber	199
<b>ARLT-FISCHER</b> , Iris Forceps	85	Cannulas, Anterior Chamber Irrigation	198
<b>ARRUGA</b> , Capsular Forceps	89	Cannulas, Cyclodialysis	203
<b>ARRUGA</b> , Micro Needle Holders	132	Cannulas, Cystotome	203
<b>ARRUGA</b> , Protectors	171	Cannulas, Injection	201
<b>ARRUGA-KALT</b> , Micro Needle Holders	132	Cannulas, Irrigation	198
Artery Forceps	78	Cannulas, Lacrimal	200
Axis Markers	190	Capsular Forceps	88, 89
<b>AYER</b> , Chalazion Forceps	95	Capsule Polishers	202
B			
<b>BACKHAUS</b> , Towel Forceps	79	Capsule Scrapers	202
<b>BARKAN</b> , Goniotomy Knives	174	Capsulorhexis Forceps	97
<b>BARRAQUER PHAKO</b> , Eye Specula	166	Capsulotomy Scissors	109
<b>BARRAQUER</b> , Anterior Chamber Forceps	91	<b>CASTROVIEJO</b> , Caliper	143
<b>BARRAQUER</b> , Cilia Forceps	83	<b>CASTROVIEJO</b> , Capsular Forceps	88
<b>BARRAQUER</b> , Eye Specula	166	<b>CASTROVIEJO</b> , Corneal Button Transfer Spoons	185
<b>BARRAQUER</b> , Micro Needle Holders with pen-type handle	129	<b>CASTROVIEJO</b> , Corneal Scissors	109, 110
<b>BARRAQUER</b> , Mini Scissors	107	<b>CASTROVIEJO</b> , Cyclodialysis Spatulas	188
<b>BARRAQUER-CASTROVIEJO</b> , Cyclodialysis Spatulas	188	<b>CASTROVIEJO</b> , Eye Specula	167
<b>BARRAQUER-COLIBRI</b> , Eye Specula	166	<b>CASTROVIEJO</b> , Fixation Forceps	90
<b>BARRAQUER-FINO</b> , Cyclodialysis Spatulas	188	<b>CASTROVIEJO</b> , Iris Scissors	107
<b>BARRAQUER-KATZIN (COLIBRI)</b> , Iris Forceps	87, 88	<b>CASTROVIEJO</b> , Keratoplasty Trephines	195
<b>BARRAQUER-KATZIN</b> , Corneal Scissors	111	<b>CASTROVIEJO</b> , Lacrimal Dilators	165
<b>BARRAQUER-KRATZ</b> , Eye Specula	166	<b>CASTROVIEJO</b> , Micro Needle Holders	131
<b>BARRAQUER-TROUTMAN</b> , Micro Needle Holders w. pen-type handle	129	<b>CASTROVIEJO</b> , Micro Needle Holders with pen-type handle	133
<b>BECHERT</b> , Lens Nucleus Rotators	158	<b>CASTROVIEJO</b> , Micro Needle Holders w. Tung. Carbide Inserts	127, 128
<b>BECHERT-JAFFE</b> , Lens Nucleus Rotators	158	<b>CASTROVIEJO</b> , Suture Forceps	91
<b>BEER</b> , Cilia Forceps	83	<b>CASTROVIEJO-BARRAQUER</b> , Cyclodialysis Spatulas	188
<b>BELL</b> , Erisiphake	202	<b>CASTROVIEJO-KALT</b> , Micro Needle Holders	132
<b>BERENS</b> , Muscular Forceps	95	Cataract Knives	174
<b>BERKE</b> , Ptosis Forceps	96	Cataract Spoons	185, 186
Bi-Coagulation-Forceps	209	<b>CHADWICK</b> , Eye Scissors	104
<b>BINKHORST</b> , Capsular Forceps	89	Chalazion Curettes	185, 186
<b>BISHOP-HARMON</b> , Anterior Chamber Irrigation Cannulas	198	Chalazion Forceps	95, 96
<b>BISHOP-HARMON</b> , Iris Forceps	87	Chisels	151
Blade Breakers	124	<b>CHRIS-TROUTMAN</b> , Blade Breakers	124
Blade, Phaco Chopper	159	Cilia Forceps	83
<b>BLASCOVICS</b> , Muscular Forceps	94	<b>CITELLI</b> , Punches	154
<b>BÖHLER</b> , Bone Rongeurs	151	Clamps, Bulldog	77
<b>BONACCOLTO</b> , Strabismus Forceps	92	<b>CLAYMAN</b> , Lens Nucleus Rotators	158
Bone Rongeurs	151	<b>CLUB-GOLF</b> , Foreign Body Spuds	177
<b>BONN</b> , Fine Scissors	101	<b>COLIBRI-BARRAQUER</b> , Eye Specula	166
<b>BONN</b> , Fixation Rings	194	<b>COLLIN</b> , Scalpel Handles	121
<b>BONN</b> , Iris Forceps	86, 87	Connection Cords	209
<b>BONN</b> , Iris Hooks	156	Connection, Luer-Lock	198
<b>BONN</b> , Irrigation Cannulas	198	<b>COOK</b> , Eye Specula	168
<b>BONN</b> , Scleral Knives	174	<b>CORCELLE</b> , Eye Specula	166
		Corneal Burrs	196
		Corneal Button Transfer Spoons	185
		Corneal Knives	173

	Page		Page
Corneal Markers	191	Forceps, Cilia	83
Corneal Scarifiers	173	Forceps, Entropium	95
Corneal Scissors	87-90	Forceps, Fixation	89, 90
Corneal Trephines	195, 196	Forceps, Iris	46
Cortex Extractors	200	Forceps, Lens Holding	97
<b>CULLER</b> , Iris Spatulas	189	Forceps, Muscular	94, 95
Curettes, Chalazion	185, 186	Forceps, Setting	77
<b>CUSHING</b> , Delicate Hooks	149	Forceps, Strabismus	92
Cyclodialysis Cannulas	203	Forceps, Suture	46
Cyclodialysis Spatulas	188	Forceps, Towel	79, 80
Cystotome Cannulas	203	Foreign Body Instruments	178
Cystotomes	175	Foreign Body Needles	176-178
D		Foreign Body Spuds	176-178
<b>DAVIEL</b> , Cataract Spoons	186	<b>FRANCESCHETTI</b> , Keratoplasty Trephines	195
<b>DAVIS</b> , Foreign Body Spuds	177	<b>FRANCIS</b> , Foreign Body Spuds	177
<b>DEITZ</b> , Depth Gauges	194	<b>FRAZIER</b> , Delicate Hooks	147
Delicate Hooks	147-150	<b>FRENCH-EYE, RYDER</b> , TUC Needle Holders	126
Depressors, Scleral	172	<b>FRIEDBURG</b> , Suction- and Irrigation Cannulas	199
Depth Gauges	194	<b>FRIEDMAN</b> , Bone Rongeurs	151
<b>DERF</b> , Needle Holders	126	<b>FUCHS-GILL</b> , Capsular Forceps	88
<b>DERF</b> , TUC Needle Holders	126	G	
<b>DESMARRES</b> , Chalazion Forceps	95	<b>GASS</b> , Retinal Detachment Hooks	154
<b>DESMARRES</b> , Delicate Hooks	155	<b>GASS</b> , Scleral Marker	172
Diamond Knives	180-181	Gauges	155
<b>DIEFFENBACH</b> , Bulldog Clamps	77	Gauges, Depth	194
<b>DIETRICH</b> , Micro Needle Holders with Tungsten Carbide Inserts	128	<b>GILL</b> , Capsular Forceps	88
Dilators, Lacrimal	164, 165	<b>GILL</b> , Corneal Knives	173
Discission Knives	173	<b>GILL-FUCHS</b> , Capsular Forceps	88
<b>DISSECTION</b> , Micro Scissors	114, 116	<b>GILL-HESS</b> , Capsular Forceps	88
<b>DIX</b> , Foreign Body Instruments	178	<b>GILLIES</b> , Delicate Hooks	147
<b>DORTMUND</b> , Phako Spatulas	187	<b>GILLS-WELSH</b> , Capsulotomy Scissors	109
Double Corneal Markers	192	<b>GILLS-WELSH</b> , Cortex Extractors	200
<b>DOUGLAS</b> , Cilia Forceps	83	<b>GOLF-CLUB</b> , Foreign Body Spuds	177
Dressing Forceps	82	Goniotomy Knives	174
<b>DRYSDALE</b> , Lens Nucleus Manipulators	159	<b>GONNIN</b> , Amsler Marker	192
E		Gouges, Foreign Body	176, 178
<b>ELLIOT</b> , Handles for Trephines	196	<b>GRADLE</b> , Cilia Forceps	83
<b>ELLIOT</b> , Scleral Trephines	196	<b>GRAEFE</b> , Cataract Knives	174
<b>ELLIS</b> , Foreign Body Spuds	177	<b>GRAEFE</b> , Cataract Spoons	186
<b>ELSCHNIG</b> , Fixation Forceps	90	<b>GRAEFE</b> , Cystotomes	175
Entropium Forceps	95	<b>GRAEFE</b> , Delicate Hooks	154
Enucleation Spoons	184	<b>GRAEFE</b> , Eye Scissors	103
<b>ERHARDT</b> , Entropium Forceps	95	<b>GRAEFE</b> , Fixation Forceps	89
Erisiphake	202	<b>GRAEFE</b> , Iris Forceps	84
Exenteration Spoons	184	<b>GRAEFE</b> , Strabismus Hooks	154
Extractors, Cortex	200	<b>GRAETHER</b> , Collar Button Cannulas	202
Eye Needles	204	<b>GRANDON</b> , T-Incision Markers	190
Eye Patch	205	Grasping Forceps, Vitrectomy	183
Eye Scissors	101-105	<b>GREEN</b> , Fixation Forceps	89
Eye Specula	166-169	<b>GREEN</b> , Muscle Hooks	154
F		<b>GUTHRIE</b> , Delicate Hooks	155
<b>FAULKNER</b> , Lens Holding Forceps	97	H	
Fine Scissors	101	<b>HALLE-HARTMANN</b> , Nasal Specula	155
<b>FINO-BARRAQUER</b> , Cyclodialysis Spatulas	188	<b>HALSEY</b> , Needle Holders	126
<b>FISCHER-ARLT</b> , Iris Forceps	85	<b>HALSEY</b> , TUC Needle Holders	126
Fixation Forceps	89, 90	<b>HALSTED-MOSQUITO</b> , Artery Forceps	78
Fixation Forks	155	<b>HAMBURG</b> , Keratome	175
Fixation Rings	194, 195	Handles for Trephines	196
Flap Smoothers	171	Handles, Scalpel	121, 122
<b>FLIERINGA</b> , Fixation Rings	195	<b>HARMON-BISHOP</b> , Anterior Chamber Irrigation Cannulas	198
<b>FOERSTER</b> , Iris Forceps	86	<b>HARMON-BISHOP</b> , Iris Forceps	87
Forceps Ptosis	96	<b>HARMS</b> , Trabecular Probes	165
Forceps Tying with platform	93	<b>HARMS</b> , Tying Forceps with platform	93
Forceps, Anterior Chamber	91	<b>HARTMANN</b> , Artery Forceps	78
Forceps, Artery	78	<b>HARTMANN-HALLE</b> , Nasal Specula	155
Forceps, Bi-Coagulation	209	<b>HEBRA</b> , Chalazion Curettes	186
Forceps, Capsular	88, 89	<b>HESS</b> , Iris Forceps	86
Forceps, Capsulorhexis	97	<b>HESS-GILL</b> , Capsular Forceps	88
Forceps, Chalazion	95, 96	<b>HIRSCHMANN</b> , IOL Lens Spatulas	187

	Page		Page
<b>HIRSCHMANN</b> , Iris Hooks	157	<b>KNOLLE-JAFFE</b> , Iris Hooks	156
<b>HOFFER</b> , Optical Zone Markers	190	<b>KNOLLE-PEARCE</b> , Irrigating Vectis	201
Hook, Nucleus Dividing and Separating	159	<b>KRATZ</b> , Capsule Scraper	202
Hooks, Delicate	147-150	<b>KRATZ</b> , Cystotome Cannulas	203
Hooks, Iris	156, 157	<b>KRATZ-BARRAQUER</b> , Eye Specula	166
Hooks, Muscle	154	<b>KUHNT</b> , Corneal Scarifiers	173
Hooks, Phaco	159	<b>KUTZ-KLEINERT</b> , Delicate Hooks	147
Hooks, Phaco Splitter	159	L	
Hooks, Retinal Detachment	154	<b>LA GRANGE</b> , Eye Scissors	104
Hooks, Strabismus	154	Lacrimal Cannulas	200
Hooks, Tenotomy	155	Lacrimal Dilators	164, 165
<b>HOPKINS-JOHNS</b> , Bulldog Clamps	77	Lacrimal Probes	163
<b>HOPKINS-JOHNS</b> , Setting Forceps	77	Lacrimal Sac Retractors	170
I		<b>LAMPERT</b> , Chalazion Forceps	96
Injection Cannulas	201	<b>LANCASTER</b> , Eye Specula	168
Iris Forceps	84-88	<b>LASIK</b> , Flap Smoothers	171
Iris Hooks	156, 157	Lens Holding Forceps	97
Iris Scissors	102, 103, 106, 107	Lens Manipulators	158-161
Iris Spatulas	189	Lens Nucleus Manipulators	158, 161
Irrigating Lens Nucleus Loops	201	Lens Nucleus Rotators	158
Irrigating Vectis	201	Lens Nucleus Spatulas	187
Irrigation Cannulas	198	Lens Scoops	186
J		Lens Spatulas	187
<b>JACOBSON</b> , Micro Needle Holders	131	<b>LESTER</b> , Fixation Forceps	90
<b>JACOBSON</b> , Micro Needle Holders with Tungsten Carbide Inserts	128	<b>LESTER</b> , Lens Manipulators	161
<b>JAEGER</b> , Lid Plates	170	<b>LESTER-BURCH</b> , Eye Specula	168
<b>JAFFE</b> , Lens Spatulas	187	<b>LEWICKY</b> , Lens Manipulators	160
<b>JAFFE</b> , Lid Retractors	170	<b>LEWIS</b> , Lens Scoops	186
<b>JAFFE-BECHERT</b> , Lens Nucleus Rotators	158	Lid Plates	170
<b>JAFFE-KNOLLE</b> , Iris Hooks	156	<b>LIEBERMAN</b> , Eye Specula	169
<b>JAFFE-MALTZMANN</b> , Lens Manipulators	161	Ligature Scissors	106
<b>JAMESON</b> , Caliper	143	Limbal Incision Rulers	193
<b>JAMESON</b> , Muscle Hooks	154	<b>LINDSTROM</b> , Corneal Markers	191
<b>JAMESON</b> , Muscular Forceps	94	<b>LIPPMAN</b> , Lens Nucleus Spatulas	187
<b>JAPAN-TOHOKU</b> , Towel Forceps	80	<b>LITTAUER</b> , Cilia Forceps	83
<b>JENSEN</b> , Capsule Polisher	202	Loops, Irrigating Lens Nucleus Loops	201
<b>JOHNS-HOPKINS</b> , Bulldog Clamps	77	<b>LORNA</b> , Towel Forceps	80
<b>JOHNS-HOPKINS</b> , Setting Forceps	77	<b>LU</b> , Corneal Markers Lasik	191
<b>JONES</b> , Towel Forceps	79	<b>LUER</b> , Bone Rongeurs	151
K		<b>LUER-LOCK</b> , Connection	198
<b>KALT</b> , Micro Needle Holders	132	M	
<b>KALT</b> , Micro Needle Holders with Tungsten Carbide Inserts	128	Magnetic Eye Probes with Foreign Body Loop	178
<b>KALT-ARRUGA</b> , Micro Needle Holders	132	Mallet	151
<b>KALT-CASTROVIEJO</b> , Micro Needle Holders	132	<b>MALONEY</b> , Keratometers	193
<b>KATZIN</b> , Corneal Scissors	110	<b>MALTZMANN-JAFFE</b> , Lens Manipulators	161
<b>KATZIN-BARRAQUER (COLIBRI)</b> , Iris Forceps	87, 88	Manipulators, Lens	158-161
<b>KATZIN-BARRAQUER</b> , Corneal Scissors	111	Manipulators, Lens Nucleus	158, 161
<b>KELMAN</b> , Cyclodialysis Cannulas	203	Marker, Scleral	172
<b>KELMAN</b> , Cystotome Cannulas	203	Markers, Amsler	192
<b>KELMAN-McPHERSON</b> , Tying Forceps with platform	92	Markers, Axis	190
Keratome	175	Markers, Corneal	191
Keratometers	193	Markers, Double Corneal	192
Keratoplasty Knives	175	Markers, Optical Zone	190
<b>KERRISON</b> , Sphenoid Punches	155	Markers, Radial	190
<b>KILNER</b> , Delicate Hooks	147	Markers, Suture Placement	192
<b>KIRBY</b> , Iris Forceps	87	Markers, T-Incision	190
<b>KLEINERT-KUTZ</b> , Delicate Hooks	147	<b>MARTIN</b> , Keratoplasty Trephines	195
<b>KNAPP</b> , Corneal Button Transfer Spoons	185	<b>MARTIN, ST.</b> Suture Forceps	91
<b>KNAPP</b> , Delicate Hooks	155	<b>MAUMENEE-PARK</b> , Eye Specula	167
Knives, Cataract	174	Mc <b>DONALD</b> , Capsulorhexis Forceps	97
Knives, Corneal	173	Mc <b>INTYRE</b> , Anterior Chamber Cannulas	199
Knives, Diamond	180-181	Mc <b>INTYRE</b> , Irrigation Cannulas	198
Knives, Discission	173	Mc <b>PERSON</b> , Suture Forceps	91
Knives, Goniotomy	174	Mc <b>PERSON-KELMAN</b> , Tying Forceps with platform	92
Knives, Keratoplasty	175	Measuring Instruments	143, 194
Knives, Scleral	174	<b>MENDEZ</b> , Measuring Instruments Degree	194
<b>KNOLLE</b> , Capsule Polisher	202	<b>MEYHOEFER</b> , Chalazion Curettes	185
<b>KNOLLE</b> , Iris Hooks	156	Micro Needle Holders	128-133
<b>KNOLLE</b> , Lens Nucleus Spatulas	187	Micro Needle Holders with pen-type handle	128, 129, 130, 130

	Page		Page
Micro Needle Holders with Tungsten Carbide Inserts	127, 128	Punches	154
Micro Scissors	112-118	R	
Micro Scissors, Adventitia	114, 116	Radial Markers	190
Micro Scissors, Dissection	113, 116	Razor Blades	124
Micro Scissors, Nerve	116	<b>REILL</b> , Micro Needle Holders with pen-type handle	130
<b>MICRO-ADSON</b> , Dressing Forceps	82	Remover, Rust Ring	195
<b>MICRO-ADSON</b> , Tissue Forceps	82	<b>RENTSCH</b> , Lens Manipulators	161
Mini Scissors	107	Retinal Detachment Hooks	154
<b>MOD. BONN</b> , Fine Scissors	101	Retractors, Lacrimal Sac	170
<b>MOD. BONN</b> , Iris Forceps	86, 87	Retractors, Orbital	171
<b>MOD. BONN</b> , Irrigation Cannulas	198	<b>RIBBON</b> , Eye Scissors	105
<b>MOD. BONN</b> , Tying Forceps with platform	92	<b>ROEDER</b> , Towel Forceps	79
<b>MOD. DORTMUND</b> , Phaco Spatulas	187	<b>ROLLET</b> , Delicate Hooks	155
<b>MOD. HAMBURG</b> , Keratome	175	<b>ROSEN</b> , Phaco Splitter Hooks	159
<b>MOD. TÜBINGEN</b> , Suture Forceps	92	Rotators, Lens Nucleus	158
<b>MOD. TÜBINGEN-VANNAS</b> , Secondary Cataract Scissors	108	<b>RUEDEMANN</b> , Lacrimal Dilators	164
<b>MOLDESTAD</b> , Delicate Hooks	149	Rulers, Limbal Incision	193
<b>MOORFIELD</b> , Suture Forceps	90	Rust Ring Remover	195
<b>MOSQUITO, HALSTED</b> Artery Forceps	78	<b>RYDER/FRENCH-EYE</b> , TUC Needle Holders	126
<b>MULDOON</b> , Lacrimal Dilators	164	S	
Muscle Hooks	154	<b>SATO</b> , Corneal Knives	173
Muscular Forceps	94, 95	<b>SATTLER</b> , Muscular Forceps	94
N		<b>SAUER</b> , Eye Specula	168
<b>NAGAHARA</b> , Phaco Chopper Blade	159	<b>SAUTTER</b> , Air Injection Cannulas	199
Nasal Specula	155	<b>SAUTTER</b> , Orbital Spatulas	171
Needle Holders, Micro	128-133	Scalpel Blades	122, 123
Needle Holders, Micro with pen-type handle	128, 129, 130, 133	Scalpel Handles	121, 122
Needle Holders, Micro with Tungsten Carbide Inserts	127, 128	Scarifiers, Corneal	173
Needles, Eye	204	<b>SCHAEDEL</b> , Towel Forceps	79
Needles, Foreign Body	176-178	<b>SCHEPENS</b> , Orbital Retractors	171
<b>NERVE</b> , Micro Scissors	116	<b>SCHEPENS</b> , Sklera Depressors	172
<b>NEW ORLEANS</b> , Lens Scoops	186	<b>SCHIOETZ</b> , Tonometers	193
<b>NOYES</b> , Iris Scissors	106	<b>SCHOCKET</b> , Sklera Depressors	172
<b>NOYES</b> , Micro Corneal Scissors	112	<b>SCHOTT</b> , Eye Specula	167
Nucleus Dividing and Separating Hook	159	Scissors, Capsulotomy	109
O		Scissors, Corneal	87-90
<b>OB</b> , Eye Needles	204	Scissors, Eye	101-105
<b>OBSTBAUM</b> , Lens Spatulas	187	Scissors, Fine	101
<b>O'CONNOR</b> , Delicate Hooks	154	Scissors, Iris	102, 103, 106, 107
<b>OG</b> , Eye Needles	204	Scissors, Micro	112-118
Ophthalmoscope	144	Scissors, Mini	107
Optical Zone Markers	190	Scissors, Secondary Cataract	108, 109
Orbital Retractors	171	Scissors, Strabismus	103, 112
Orbital Spatulas	171	Scissors, Tenotomy	104, 109
<b>OSHER</b> , Lens Nucleus Manipulators	158	Scissors, Vitrectomy	182
P		Scleral Depressors	172
<b>PARK-MAUMENEE</b> , Eye Specula	167	Scleral Fixation Rings	195
<b>PARTSCH</b> , Chisels	151	Scleral Knives	174
<b>PARTSCH</b> , Mallet	151	Scleral Marker	172
<b>PATON</b> , Micro Needle Holders	132	Scrapers, Capsule	202
<b>PAUFIQUE</b> , Keratoplasty Knives	175	Secondary Cataract Scissors	108, 109
<b>PAUFIQUE</b> , Suture Forceps	93	Sets	55-64
<b>PEARCE-KNOLLE</b> , Irrigating Vectis	201	Setting Forceps	77
<b>PEERS</b> , Towel Forceps	80	<b>SIMCOE</b> , Cortex Extractors	200
Phaco Chopper Blade	159	<b>SIMCOE</b> , Irrigating Lens Nucleus Loops	201
Phaco Hooks	159	<b>SIMCOE</b> , Suction-and Irrigation Cannulas	199
Phaco Spatulas	187	<b>SINSKEY</b> , Lens Manipulators	160
Phaco Splitter Hooks	159	<b>SMITH-POTTS</b> , Micro Needle Holders	132
<b>PHAKO BARRAQUER</b> , Eye Specula	166	<b>SMITH-POTTS</b> , Micro Needle Holders with Tungsten Carbide Inserts	128
Pigtail Probes	165	Smoothers, Flap	171
<b>PLEY</b> , Eye Specula	168	<b>SNELLEN</b> , Entropium Forceps	95
Polisher, Capsule	202	<b>SNELLEN</b> , Lens Scoops	186
<b>POTTS-SMITH</b> , Micro Needle Holders	132	Spatulas, Cyclodialysis	188
<b>POTTS-SMITH</b> , Micro Needle Holders with Tungsten Carbide Inserts	128	Spatulas, Iris	189
<b>PRINCE</b> , Muscular Forceps	94	Spatulas, Lens	187
Probes, Lacrimal	163	Spatulas, Lens Nucleus	187
Probes, Pigtail	165	Spatulas, Orbital	171
Probes, Trabecular	165	Spatulas, Phaco	187
Ptosis Forceps	96	Specula, Eye	166-169

	Page		Page
<b>SPENCER</b> , Ligature Scissors	106		
Sphenoid Punches	155		
Spoons, Cataract	185, 186	<b>Z</b>	
Spoons, Corneal Button Transfer	185	<b>ZIEGLER</b> , Cilia Forceps	83
Spoons, Enucleation	184	<b>ZIEGLER</b> , Discission Knives	173
Spoons, Exenteration	184		
Spuds, Foreign Body	176-178		
<b>ST. MARTIN</b> , Suture Forceps	91		
<b>STEVENS</b> , Iris Forceps	85		
<b>STEVENS</b> , Micro Needle Holders	132		
<b>STEVENS</b> , Tenotomy Hooks	155		
<b>STEVENS</b> , Tenotomy Scissors	104		
<b>STEVENSON</b> , Lacrimal Sac Retractors	170		
<b>STILLE</b> , Foreign Body Instruments	178		
<b>STORZ</b> , Corneal Burrs	196		
Strabismus Forceps	92		
Strabismus Hooks	154		
Strabismus Scissors	103, 112		
Suture Forceps	90-93		
Suture Placement Markers	192		
<b>T</b>			
Tenotomy Hooks	155		
Tenotomy Scissors	104, 109		
<b>TERSON</b> , Capsular Forceps	88		
<b>THORNTON</b> , Double Corneal Markers	192		
<b>THORNTON</b> , Fixation Rings	194		
<b>THORNTON</b> , Limbal Incision Rulers	192		
T-Incision Markers	190		
Tissue Forceps	82		
<b>TOHOKU-JAPAN</b> , Towel Forceps	80		
Tonometers	193		
<b>TOOK</b> , Corneal Knives	173		
Towel Forceps	79, 80		
Trabecular Probes	165		
Trephines, Corneal	195, 196		
Trephines, Scleral	196		
<b>TROUTMAN (CORNEAL)</b> , Iris Forceps	88		
<b>TROUTMAN</b> , Alpha-Chymotrypsin Cannulas	203		
<b>TROUTMAN</b> , Corneal Scissors	110		
<b>TROUTMAN</b> , Micro Needle Holders with pen-type handle	130		
<b>TROUTMAN-BARRAQUER</b> , Micro Needle Holders w. pen-type handle	129		
<b>TROUTMAN-CHRIS</b> , Blade Breakers	124		
<b>TÜBINGEN</b> , Suture Forceps	92		
<b>TÜBINGEN-VANNAS</b> , Secondary Cataract Scissors	108		
Tying Forceps with platform	93		
<b>TYRELL</b> , Iris Hooks	157		
<b>V</b>			
<b>VANNAS</b> , Secondary Cataract Scissors	108		
<b>VANNAS-MOD. TÜBINGEN</b> , Secondary Cataract Scissors	108		
Vectis, Irrigating	201		
ping Forceps	183		
Vitrectomy Instruments	182, 183		
Vitrectomy Scissors	182		
<b>W</b>			
<b>WECKER</b> , Iris Scissors	106		
<b>WECKER</b> , Iris Spatulas	189		
<b>WELLS</b> , Enucleation Spoons	184		
<b>WELSH</b> , Cortex Extractors	200		
<b>WELSH-GILLS</b> , Capsulotomy Scissors	109		
<b>WELSH-GILLS</b> , Cortex Extractors	200		
<b>WEST</b> , Gauges	155		
<b>WESTCOTT</b> , Strabismus Scissors	112		
<b>WESTCOTT</b> , Tenotomy Scissors	109		
<b>WHEELER</b> , Discission Knives	173		
<b>WILDER</b> , Lacrimal Dilators	164		
<b>WILLIAMS</b> , Eye Specula	166		
<b>WILMER</b> , Eye Scissors	103		
<b>WORST</b> , Pigtail Probes	165		



# Índice alfabético

	Página		Página
<b>A</b>			
<b>ADSON, MICRO</b> Pinzas de disección	82	<b>BROWN-ADSON</b> , Pinzas de disección con dientes	82
<b>ADSON, MICRO</b> Pinzas de disección con dientes	82	BUNGE, Cucharas para exenteración	184
<b>ADSON</b> , Pinzas de disección	82	BUNNKATU, Ganchos para manipular de núcleo	159
<b>ADSON</b> , Pinzas de disección con dientes	82	BURCH, Horquilla fijadora	155
<b>ADSON-BROWN</b> , Pinzas de disección con dientes	82	BURCH-LESTER, Blefarostatos	168
<b>ADVENTITIA</b> , Micro Tijeras	114, 116	<b>C</b>	
<b>AGRICOLA</b> , Separadores para saco lacrimal	170	Cables de conexión	209
Agujas oculares	204	Cánulas Alpha-Chymotrypsin	203
Agujas para cuerpos extraños	176-178	Cánulas cistótomo	203
<b>ANEL</b> , Cánulas lacrimales	200	Cánulas de irrigación para cámara anterior	198, 199
Anillo removedor de óxido	195	Cánulas lacrimales	200
Anillos de fijación	194, 195	Cánulas para núcleo con irrigación	201
<b>ANIS</b> , Marcadores para sutura	192	Cánulas para ciclodíalisis	203
<b>ANIS</b> , Marcadores radiales	190	Cánulas para inyección	201
<b>ARLT</b> , Asas para catarata	186	Cánulas para inyectar aire	199
<b>ARLT-FISCHER</b> , Pinzas para iris	85	Cánulas para irrigación	199
<b>ARRUGA</b> , Micro-porta-agujas	132	CASTROVIEJO, Blefarostatos	167
<b>ARRUGA</b> , Pinzas capsulares	89	CASTROVIEJO, Círculo	143
<b>ARRUGA</b> , Protector	171	CASTROVIEJO, Cucharas para transferir la córnea	185
<b>ARRUGA-KALT</b> , Micro-porta-agujas	132	CASTROVIEJO, Dilatadoras para canal lacrimal	165
Asas para catarata	186	CASTROVIEJO, Espátulas para ciclodíalisis	188
Asas para cristalino con irrigación	201	CASTROVIEJO, Micro-porta-agujas	131
<b>AYER</b> , Pinzas de chalazión	95	CASTROVIEJO, Micro-porta-agujas, carburo de Tungsteno	127, 128
<b>B</b>			
<b>BACKHAUS</b> , Pinzas de campo	79	CASTROVIEJO, Micro-porta-agujas con mango redondo	133
<b>BARKAN</b> , Cuchillos para goniotomía	174	CASTROVIEJO, Pinzas capsulares	88
<b>BARRAQUER PHAKO</b> , Blefarostatos	166	CASTROVIEJO, Pinzas de fijación	90
<b>BARRAQUER</b> , Blefarostatos	166	CASTROVIEJO, Pinzas para sutura	91
<b>BARRAQUER</b> , Micro-porta-agujas con mango redondo	129	CASTROVIEJO, Pinzas-tijeras para córnea	109, 110
<b>BARRAQUER</b> , Pinzas de depilatorias	83	CASTROVIEJO, Pinzas-tijeras para iridectomía	107
<b>BARRAQUER</b> , Pinzas para la cámara anterior	91	CASTROVIEJO, Trépanos corneales	195
<b>BARRAQUER</b> , Pinzas-tijeras para iridectomía	107	CASTROVIEJO-BARRAQUER, Espátulas para ciclodíalisis	188
<b>BARRAQUER-CASTROVIEJO</b> , Espátulas para ciclodíalisis	188	CASTROVIEJO-KALT, Micro-porta-agujas	132
<b>BARRAQUER-COLIBRI</b> , Blefarostatos	166	CHADWICK, Tijeras oculares	104
<b>BARRAQUER-FINO</b> , Espátulas para ciclodíalisis	188	CHRIS-TROUTMAN, Pinzas para romper hojas	124
<b>BARRAQUER-KATZIN (COLIBRI)</b> , Pinzas para iris	87, 88	Cinceles	151
<b>BARRAQUER-KATZIN</b> , Pinzas-tijeras para córnea	111	Cinceles para cuerpos extraños	176-178
<b>BARRAQUER-KRATZ</b> , Blefarostatos	166	Círculo	143
<b>BARRAQUER-TROUTMAN</b> , Micro-porta-agujas con mango redondo	129	CITELLI, Pinzas osteótomos	154
<b>BECHERT</b> , Ganchos para voltear núcleo	158	Clamps Bulldog	77
<b>BECHERT-JAFFE</b> , Ganchos para voltear núcleo	158	CLAYMAN, Ganchos para voltear núcleo	158
<b>BEER</b> , Pinzas de depilatorias	83	COLIBRI-BARRAQUER, Blefarostatos	166
<b>BELL</b> , Erisiphake	202	COLLIN, Mangos de bisturís	121
<b>BERENS</b> , Pinzas musculares	95	COOK, Blefarostatos	168
<b>BERKE</b> , Pinzas de chalazión	96	CORCELLE, Blefarostatos	166
<b>BINKHORST</b> , Pinzas capsulares	89	Cucharas para enucleación	184
<b>BISHOP-HARMON</b> , Cánulas de irrigación para cámara anterior	198	Cucharas para exenteración	184
<b>BISHOP-HARMON</b> , Pinzas para iris	87	Cucharas para transferir la córnea	185
Bisturís de diamante	180-181	Cucharillas para catarata	186
<b>BLASCOVICS</b> , Pinzas musculares	94	Cucharillas para chalazión	185, 186
Blefarostatos	166-169	Cuchillos para catarata	174
<b>BÖHLER</b> , Pinzas-gubias	151	Cuchillos para discisión	173
<b>BONACCOLTO</b> , Pinzas para sutura	92	Cuchillos para esclerótica	174
<b>BONN MOD.</b> , Pinzas para sutura	92	Cuchillos para goniotomía	174
<b>BONN</b> , Anillos de fijación	194	Cuchillos para la córnea	173
<b>BONN</b> , Cánulas para irrigación	198	Cuchillos para queratoplástica	175
<b>BONN</b> , Cuchillos para esclerótica	174	CULLER, Espátulas para iris	189
<b>BONN</b> , Ganchos para iris	156	CUSHING, Ganchos	149
<b>BONN</b> , Pinzas para iris	86, 87	<b>D</b>	
<b>BONN</b> , Tijeras finas	101	DAVIEL, Cucharillas para catarata	186
<b>BORES</b> , Marcadores axiales	190	DAVIS, Cinceles para cuerpos extraños	177
<b>BOWMAN</b> , Blefarostatos	166	DEITZ, Medidor de profundidad	194
<b>BOWMAN</b> , Sondas exploradoras para canal lacrimal	163	Depresores	172
		DERF, Porta-agujas	126
		DERF, Porta-agujas con bocas de carburo de Tungsteno	126
		DESMARRES, Ganchos	155

DESMARRES, Pinzas de chalazión	95	<b>GREEN</b> , Ganchos de músculos	154
<b>DIEFFENBACH</b> , Clamps Bulldog	77	<b>GREEN</b> , Pinzas de fijación	89
<b>DIETHRICH</b> , Micro-porta-agujas con bocas de carburo de Tungsteno	128	Gubias	155
Dilatadoras para canal lacrimal	164, 165	Gubias para cuerpos extraños	176-178
<b>DISSECTION</b> , Micro Tijeras	114, 116	<b>GUTHRIE</b> , Ganchos	155
<b>DIX</b> , Instrumento para cuerpos extraños	178	H	
<b>DORTMUND</b> , Espátulas para fako	187	<b>HALLE-HARTMANN</b> , Espéculos nasales	155
<b>DOUGLAS</b> , Pinzas de depilatorias	83	<b>HALSEY</b> , Porta-agujas	126
<b>DRYSDALE</b> , Ganchos para posicionar cristalino	159	<b>HALSEY</b> , Porta-agujas con bocas de carburo de Tungsteno	126
E		<b>HALSTED-MOSQUITO</b> , Pinzas hemostáticas	78
<b>ELLIOT</b> , Trépanos corneales	196	<b>HAMBURG</b> , Querátomo	175
<b>ELLIS</b> , Cinceles para cuerpos extraños	177	<b>HARMON-BISHOP</b> , Cánulas de irrigación para cámara anterior	198
<b>ELSCHNIG</b> , Pinzas de fijación	90	<b>HARMON-BISHOP</b> , Pinzas para iris	87
<b>ERHARDT</b> , Pinzas de entropión	95	<b>HARMS</b> , Pinzas de ligadura con plataforma	93
Erisiphake	202	<b>HARMS</b> , Sondas trabeculares	165
Espátulas orbitales	171	<b>HARTMANN</b> , Pinzas hemostáticas	78
Espátulas para ciclodíálisis	188	<b>HARTMANN-HALLE</b> , Espéculos nasales	155
Espátulas para fako	187	<b>HEBRA</b> , Cucharillas para chalazión	186
Espátulas para iris	189	<b>HESS</b> , Pinzas para iris	86
Espátulas para manipular	187	<b>HESS-GILL</b> , Pinzas para iris	88
Espátulas para manipular	187	<b>HIRSCHMANN</b> , Ganchos para iris	157
Espátulas para núcleo cristalino	187	<b>HIRSCHMANN, IOL</b> Espátulas para manipular	187
Espéculos nasales	155	<b>HOFFER</b> , Marcadores para centro óptico	190
Extractor para corteza	200	Hojas de afeitar	124
F		Hojas de bisturíes	122, 123
<b>FAULKER</b> , Pinzas para tener cristalino	97	<b>HOPKINS-JOHNS</b> , Clamps Bulldog	77
<b>FINO-BARRAQUER</b> , Espátulas para ciclodíálisis	188	<b>HOPKINS-JOHNS</b> , Pinzas para poner	77
<b>FISCHER-ARLT</b> , Pinzas para iris	85	Horquilla fijadora	155
<b>FLIERINGA</b> , Anillos de fijación	195	I	
<b>FOERSTER</b> , Pinzas para iris	86	Imán oftálmico con asa para cuerpos extraños	178
<b>FRANCESCHETTI</b> , Trépanos corneales	195	Instrumentos de vitrectomía	182, 183
<b>FRANCIS</b> , Cinceles para cuerpos extraños	177	Instrumentos para medidas	143
<b>FRAZIER</b> , Ganchos	147	J	
<b>FRENCH-EYE/Ryder</b> , Porta-agujas, carburo de Tungsteno	126	<b>JACOBSON</b> , Micro-porta-agujas	131
Fresas corneales	195, 196	<b>JACOBSON</b> , Micro-porta-agujas con bocas de carburo de Tungsteno	128
<b>FRIEDMAN</b> , Pinzas-gubias	151	<b>JAEGER</b> , Placa para párpados	170
<b>FUCHS-GILL</b> , Pinzas para iris	88	<b>JAFFE</b> , Blefarostatos	170
G		<b>JAFFE</b> , Espátulas para manipular	187
Ganchos	147-150	<b>JAFFE-BECHERT</b> , Ganchos para voltear núcleo	158
Ganchos de músculos	154	<b>JAFFE-KNOLLE</b> , Ganchos para iris	156
Ganchos de tenotomía	155	<b>JAFFE-MALTZMANN</b> , Ganchos para posicionar cristalino	161
Ganchos para desprendimiento de retina	154	<b>JAMESON</b> , Calibrador	143
Ganchos para estrabismo	154	<b>JAMESON</b> , Ganchos de músculos	154
Ganchos para fako	159	<b>JAMESON</b> , Pinzas musculares	94
Ganchos para iris	156, 157	<b>JAPAN-TOHOKU</b> , Pinzas de campo	80
Ganchos para posicionar cristalino	158, 160, 161	<b>JENSEN</b> , Pulidor para cápsula	202
eo	158	<b>JOHNS-HOPKINS</b> , Clamps Bulldog	77
<b>GASS</b> , Ganchos para desprendimiento de retina	154	<b>JOHNS-HOPKINS</b> , Pinzas para poner	77
<b>GASS</b> , Marcadores de esclerótica	172	<b>JONES</b> , Pinzas de campo	79
<b>GILL</b> , Cuchillos para la córnea	173	K	
<b>GILL</b> , Pinzas para iris	88	<b>KALT</b> , Micro-porta-agujas	132
<b>GILL-FUCHS</b> , Pinzas para iris	88	<b>KALT</b> , Micro-porta-agujas con bocas de carburo de Tungsteno	128
<b>GILL-HESS</b> , Pinzas para iris	88	<b>KALT-ARRUGA</b> , Micro-porta-agujas	132
<b>GILLIES</b> , Ganchos	147	<b>KALT-CASTROVIEJO</b> , Micro-porta-agujas	132
<b>GILLS-WELSH</b> , Extractor para corteza	200	<b>KATZIN</b> , Pinzas-tijeras para córnea	110
<b>GILLS-WELSH</b> , Tijeras para capsulotomía	109	<b>KATZIN-BARRAQUER (COLIBRI)</b> , Pinzas para iris	87, 88
<b>GOLF-CLUB</b> , Cinceles para cuerpos extraños	177	<b>KATZIN-BARRAQUER</b> , Pinzas-tijeras para córnea	111
<b>GONNIN</b> , Marcadores Amsler	192	<b>KELMAN</b> , Cánulas cistótomo	203
<b>GRADLE</b> , Pinzas de depilatorias	83	<b>KELMAN</b> , Cánulas para ciclodíálisis	203
<b>GRAEFE</b> , Cucharillas para catarata	186	<b>KELMAN-McPHERSON</b> , Pinzas para sutura	92
<b>GRAEFE</b> , Cuchillos para catarata	174	<b>KERRISON</b> , Pinzas para seno esfenoidal	155
<b>GRAEFE</b> , Ganchos	154	<b>KILNER</b> , Ganchos	147
<b>GRAEFE</b> , Ganchos para estrabismo	154	<b>KIRBY</b> , Pinzas para iris	87
<b>GRAEFE</b> , Pinzas de fijación	89	<b>KLEINERT-KUTZ</b> , Ganchos	147
<b>GRAEFE</b> , Pinzas para iris	84	<b>KNAPP</b> , Cucharas para transferir la córnea	185
<b>GRAEFE</b> , Quistótomos	175	<b>KNAPP</b> , Ganchos	155
<b>GRAEFE</b> , Tijeras oculares	103	<b>KNOLLE</b> , Espátulas para núcleo cristalino	187
<b>GRAETHER</b> , Cánula	202	<b>KNOLLE</b> , Ganchos para iris	156
<b>GRANDON</b> , Marcadores para T-Inzisión	190	<b>KNOLLE</b> , Pulidor para cápsula	202



	Página		Página
<b>KNOLLE-JAFFE</b> , Ganchos para iris	156	<b>N</b>	
<b>KNOLLE-PEARCE</b> , Asas para cristalino con irrigación	201	<b>NAGAHARA</b> , Facó Chopper hojas	159
<b>KRATZ</b> , Cánulas cistótomo	203	<b>NERVE</b> , Micro Tijeras	116
<b>KRATZ</b> , Pulidor para cápsula	202	<b>NEW ORLEANS</b> , Asas para catarata	186
<b>KRATZ-BARRAQUER</b> , Blefarostatos	166	<b>NOYES</b> , Micro Tijeras	112
<b>KUHNT</b> , Rescadores para la córnea	173	<b>NOYES</b> , Pinzas-tijeras para iridectomía	106
<b>KUTZ-KLEINERT</b> , Ganchos	147	<b>O</b>	
<b>L</b>		<b>OB</b> , Agujas oculares	204
<b>LA GRANGE</b> , Tijeras oculares	104	<b>OBSTBAUM</b> , Espátulas para manipular	187
<b>LAMPERT</b> , Pinzas de chalazión	96	<b>O'CONNOR</b> , Ganchos	154
<b>LANCASTER</b> , Blefarostatos	168	Oftalmoscopio	144
<b>LASIK</b> , Manipulador para flap de córnea	171	<b>OG</b> , Agujas oculares	204
<b>LESTER</b> , Ganchos para posicionar cristalino	161	<b>OSHER</b> , Ganchos para posicionar cristalino	158
<b>LESTER</b> , Pinzas de fijación	90	<b>P</b>	
<b>LESTER-BURCH</b> , Blefarostatos	168	<b>PARK-MAUMENEE</b> , Blefarostatos	167
<b>LEWICKY</b> , Ganchos para posicionar cristalino	160	<b>PARTSCH</b> , Cinceles	151
<b>LEWIS</b> , Asas para catarata	186	<b>PARTSCH</b> , Martillos	151
<b>LIEBERMAN</b> , Blefarostatos	169	<b>PATON</b> , Micro-porta-agujas	132
<b>LINDSTROM</b> , Marcadores corneales	191	<b>PAUFIQUE</b> , Chuchillos para queratoplástica	175
<b>LIPPMAN</b> , Espátulas para núcleo cristalino	187	<b>PAUFIQUE</b> , Pinzas para sutura	93
<b>LITTAUER</b> , Pinzas de depilatorias	83	<b>PEARCE-KNOLLE</b> , Asas para cristalino con irrigación	201
<b>LORNA</b> , Pinzas de campo	80	<b>PEERS</b> , Pinzas para compresas	80
<b>LU</b> , Marcadores corneales Lasik	191	<b>PHAKO BARRAQUER</b> , Blefarostatos	166
<b>LUER</b> , Pinzas-gubias	151	Pincel	205
<b>M</b>		Pinzas capsulares	88, 89
<b>MALONEY</b> , Queratómetros	193	Pinzas capsulorhexis	97
<b>MALTMANN-JAFFE</b> , Ganchos para posicionar cristalino	161	Pinzas de campo	79, 80
Mangos de bisturíes	121, 122	Pinzas de chalazión	95, 96
Manipulador para flap de córnea	171	Pinzas de depilatorias	83
Marcadores axiales	190	Pinzas de disección	82
Marcadores corneales	191, 192	Pinzas de disección con dientes	82
Marcadores de esclerótica	172	Pinzas de entropión	95
Marcadores para centro óptico	190	Pinzas de fijación	89, 90
Marcadores para incisión limbal	192	Pinzas de ligadura con plataforma	93
Marcadores para suturas	192	Pinzas de vitrectomía	183
Marcadores para T-inzision	190	Pinzas hemostáticas	78
Marcadores radiales	190	Pinzas musculares	94, 95
Martillos	151	Pinzas osteótomas	154
<b>MARTIN</b> , Trépanos corneales	195	Pinzas para Bi-Coagulación	209
<b>MAUMENEE-PARK</b> , Blefarostatos	167	Pinzas para compresas	79, 80
McDONALD, Pinzas capsulorhexis	97	Pinzas para iris	84-88
McINTYRE, Cánulas para cámara anterior	199	Pinzas para poner	77
McINTYRE, Cánulas para irrigación	198	Pinzas para romper hojas	124
McPHERSON, Pinza para sutura	91	Pinzas para seno esfenoidal	155
McPHERSON-KELMAN, Pinzas para sutura	92	Pinzas para sutura	90-93
Medidor de profundidad	194	Pinzas para tener cristalino	97
<b>MENDEZ</b> , Instrumentos para medidas	194	Pinzas-gubias	151
<b>MEYHOEFER</b> , Cucharillas para chalazión	185	Pinzas-tijeras para catarata secundaria	108, 109
Micro Tijeras	112-118	Pinzas-tijeras para córnea	87-90
Micro Tijeras, Adventitia	114, 116	Pinzas-tijeras para iridectomía	102, 106, 107
Micro Tijeras, Dissection	114, 117	Pinzas-tijeras para tenotomía	104, 109
Micro Tijeras, Nerve	116	Placa para párpados	170
<b>MICRO-ADSON</b> , Pinzas de disección	82	<b>PLEY</b> , Blefarostatos	168
<b>MICRO-ADSON</b> , Pinzas de disección con dientes	82	Porta-agujas micro con bocas de carburo de Tungsteno	127, 128
Micro-porta-agujas	128-133	Porta-agujas micro con mango redondo	128, 129, 130, 133
Micro-Porta-agujas con bocas de carburo de Tungsteno	127, 128	<b>POTTS-SMITH</b> , Micro-porta-agujas	132
Micro-porta-agujas con mango redondo	128, 119, 130, 133	<b>POTTS-SMITH</b> , Micro-porta-agujas, carburo de Tungsteno	128
<b>MOD. BONN</b> , Cánulas para irrigación	198	<b>PRINCE</b> , Pinzas musculares	94
<b>MOD. BONN</b> , Pinzas para iris	86, 87	Protector	171
<b>MOD. BONN</b> , Pinzas para sutura	92	Protectores de ojos	205
<b>MOD. BONN</b> , Tijeras finas	101	Pulidor para cápsula	202
<b>MOD. DORTMUND</b> , Espátulas para fako	187	<b>Q</b>	
<b>MOD. HAMBURG</b> , Querátomo	175	Queratómetros	193
<b>MOD. TÜBINGEN</b> , Pinzas para sutura	92	Querátomo	175
<b>MOD. TÜBINGEN-VANNAS</b> , Pinzas-tijeras para catarata secundaria	108	Quistótomos	175
<b>MOLDESTAD</b> , Ganchos	149	<b>R</b>	
<b>MOORFIELD</b> , Pinzas para sutura	90	<b>REILL</b> , Micro-porta-agujas con mango redondo	130
<b>MOSQUITO-HALSTED</b> , Pinzas hemostáticas	78	<b>RENTSCH</b> , Ganchos para posicionar cristalino	161
<b>MULDOON</b> , Dilatadoras para canal lacrimal	164	Rescadores para la córnea	173

<b>RIBBON</b> , Tijeras oculares	105	V	
<b>ROEDER</b> , Pinzas de campo	79	<b>VANNAS MOD. TÜBINGEN</b> , Pinzas-tijeras para catarata secundaria	108
<b>ROLLET</b> , Ganchos	155	<b>VANNAS</b> , Pinzas-tijeras para catarata secundaria	108
<b>ROSEN</b> , Ganchos para faco	159	W	
<b>RUEDEMANN</b> , Dilatadoras para canal lacrimal	164	<b>WECKER</b> , Espátulas para iris	189
<b>RYDER/FRENCH-EYE</b> , Porta-agujas, de carburo de Tungsteno	126	<b>WECKER</b> , Pinzas-tijeras para iridectomía	106
S		<b>WELLS</b> , Cucharas para enucleación	184
s para la córnea	173	<b>WELSH</b> , Extractor para corteza	200
<b>SATTLER</b> , Pinzas musculares	94	<b>WELSH-GILLS</b> , Extractor para corteza	200
<b>SAUER</b> , Blefarostatos	168	<b>WELSH-GILLS</b> , Tijeras para capsulotomía	109
<b>SAUTTER</b> , Cánulas para inyectar aire	199	<b>WEST</b> , Gubias	155
<b>SAUTTER</b> , Espátulas orbitales	171	<b>WESTCOTT</b> , Micro Tijeras	112
<b>SCHAEDEL</b> , Pinzas para compresas	79	<b>WESTCOTT</b> , Pinzas-tijeras para tenotomía	109
<b>SCHEPENS</b> , Depresores	172	<b>WHEELER</b> , Cuchillos para discisión	173
<b>SCHEPENS</b> , Separadores orbitales	171	<b>WILDER</b> , Dilatadoras para canal lacrimal	164
<b>SCHIOETZ</b> , Tonómetros	193	<b>WILLIAMS</b> , Blefarostatos	166
<b>SCHOCKET</b> , Depresores	172	<b>WILMER</b> , Tijeras oculares	103
<b>SCHOTT</b> , Blefarostatos	167	<b>WORST</b> , Sondas Pigtail	165
Separadores orbitales	171	Z	
Separadores para saco lacrimal	170	<b>ZIEGLER</b> , Cuchillos para discisión	173
Sets	55-64	<b>ZIEGLER</b> , Pinzas de depilatorias	83
<b>SIMCOE</b> , Cánulas para irrigación y aspiración	199		
<b>SIMCOE</b> , Cánulas para manipulación de núcleo	201		
<b>SIMCOE</b> , Extractor para corteza	200		
<b>SINSKEY</b> , Ganchos para posicionar cristalino	160		
<b>SMITH-POTTS</b> , Micro-porta-agujas	132		
<b>SMITH-POTTS</b> , Micro-porta-agujas, carburo de Tungsteno	128		
<b>SNELLEN</b> , Asas para catarata	186		
<b>SNELLEN</b> , Pinzas de entropión	95		
Sondas exploradoras para canal lacrimal	163		
Sondas pigtail	165		
Sondas trabeculares	165		
<b>SPENCER</b> , Tijeras para ligaduras	106		
<b>ST. MARTIN</b> , Pinzas para sutura	91		
<b>STEVENS</b> , Ganchos de tenotomía	155		
<b>STEVENS</b> , Micro-porta-agujas	132		
<b>STEVENS</b> , Pinzas para iris	85		
<b>STEVENS</b> , Tijeras para tenotomía	104		
<b>STEVENSON</b> , Separadores para saco lacrimal	170		
<b>STILLE</b> , Instrumento para cuerpos extraños	178		
<b>STORZ</b> , Fresas corneales	196		
T			
<b>TERSON</b> , Pinzas capsulares	88		
<b>THORNTON</b> , Anillos de fijación	194		
<b>THORNTON</b> , Marcadores corneales	192		
<b>THORNTON</b> , Marcadores incisión limbal	192		
Tijeras de vitrectomía	182		
Tijeras finas	101		
Tijeras Micro	112-118		
Tijeras oculares	101-105		
Tijeras para capsulotomía	109		
Tijeras para estrabismos	103		
Tijeras para iridectomía	102, 106, 107		
Tijeras para ligaduras	106		
Tijeras para tenotomía	104, 109		
<b>TOHOKU-JAPAN</b> , Pinzas de campo	80		
Tonómetros	193		
<b>TOOK</b> , Cuchillos para la córnea	173		
Trépanos corneales	195, 196		
<b>TROUTMAN (CORNEAL)</b> , Pinzas para iris	88		
<b>TROUTMAN</b> , Cánulas Alpha-Chymotrypsin	203		
<b>TROUTMAN</b> , Micro-porta-agujas con mango redondo	130		
<b>TROUTMAN</b> , Pinzas-tijeras para córnea	110		
<b>TROUTMAN-BARRAQUER</b> , Micro-porta-agujas con mango redondo	129		
<b>TROUTMAN-CHRIS</b> , Pinzas para romper hojas	124		
<b>TÜBINGEN MOD.</b> , Pinzas para sutura	92		
<b>TÜBINGEN-VANNAS</b> , Pinzas-tijeras para catarata secundaria	108		
<b>TYRELL</b> , Ganchos para iris	157		

# Index

	Page		Page
<b>A</b>			
<b>ADSON, MICRO</b> Pincés à dissection	82	<b>BUNGE</b> , Cuillers à éviscération	184
<b>ADSON, MICRO</b> Pincés à griffes	82	<b>BUNNKATU</b> , Crochets pour manipuler	159
<b>ADSON</b> , Pincés à dissection	82	<b>BURCH</b> , Pique de fixation	155
<b>ADSON</b> , Pincés à griffes	82	<b>BURCH-LESTER</b> , Blépharostats	168
<b>ADSON-BROWN</b> , Pincés à griffes	82	<b>C</b>	
<b>ADVENTITIA</b> , Micro Ciseaux	114, 116	Câbles de raccordement	209
<b>AGRICOLA</b> , Ecarteurs à sac lacrymal	170	Canules à chambre antérieure	198, 199
Aiguilles à corps étrangers	176-178	Canules à Injection	201
Aiguilles ophtalmiques	204	Canules à injection Alpha-Chimo-Trypsine	203
Aimant oculaire	178	Canules à injection d'air	199
<b>ANEL</b> , Canules à voies lacrymales	200	Canules à voies lacrymales	200
<b>ANIS</b> , Marqueurs	190	Canules cystotomes	203
<b>ANIS</b> , Marqueurs à sutures	192	Canules gratteuses	202
Anneaux de fixation	194, 195	Canules irrigatrice	198
Anses à cataracte	186	Canules pour cyclodialyse	203
Anses à cristallin avec irrigation	201	<b>CASTROVIEJO</b> , Blépharostats	167
<b>ARLT</b> , Anses à cataracte	186	<b>CASTROVIEJO</b> , Ciseaux à iridectomie	107
<b>ARLT-FISCHER</b> , Pincés à iris	85	<b>CASTROVIEJO</b> , Ciseaux corneales	109, 110
<b>ARRUGA</b> , Micro-porte-aiguilles	132	<b>CASTROVIEJO</b> , Compas	143
<b>ARRUGA</b> , Pincés capsulaires	89	<b>CASTROVIEJO</b> , Cuillers à transférer la cornée	185
<b>ARRUGA</b> , Protecteur	171	<b>CASTROVIEJO</b> , Dilatateurs pour le canal lacrymal	165
<b>ARRUGA-KALT</b> , Micro-porte-aiguilles	132	<b>CASTROVIEJO</b> , Micro-porte-aiguilles	131
<b>AYER</b> , Pincés à chalazion	95	<b>CASTROVIEJO</b> , Micro-porte-aiguilles à manches rondes	133
<b>B</b>			
<b>BACKHAUS</b> , Pincés à champs	79	<b>CASTROVIEJO</b> , Micro-porte-aiguilles, carbure de tungstène	127, 128
Bandeaux pour les yeux	205	<b>CASTROVIEJO</b> , Pincés à fixer	90
<b>BARKAN</b> , Couteaux à goniotomie	174	<b>CASTROVIEJO</b> , Pincés capsulaires	88
<b>BARRAQUER</b> , Blépharostats	166	<b>CASTROVIEJO</b> , Pincés pour sutures	91
<b>BARRAQUER</b> , Ciseaux à iridectomie	107	<b>CASTROVIEJO</b> , Porte-aiguilles à mors en carbure de tungstène	127, 128
<b>BARRAQUER</b> , Micro-porte-aiguilles à manches rondes	129	<b>CASTROVIEJO</b> , Spatules pour cyclodialyse	188
<b>BARRAQUER</b> , Pincés à épiler les cils	83	<b>CASTROVIEJO</b> , Trépans kéroplastie	195
<b>BARRAQUER</b> , Pincés pour la chambre antérieure	91	<b>CASTROVIEJO-BARRAQUER</b> , Spatules pour cyclodialyse	188
<b>BARRAQUER-CASTROVIEJO</b> , Spatules pour cyclodialyse	188	<b>CASTROVIEJO-KALT</b> , Micro-porte-aiguilles	132
<b>BARRAQUER-COLIBRI</b> , Blépharostats	166	<b>CHADWICK</b> , Ciseaux oculaires	104
<b>BARRAQUER-FINO</b> , Spatules pour cyclodialyse	188	<b>CHRIS-TROUTMAN</b> , Pincettes pour casser les lames	124
<b>BARRAQUER-KATZIN (COLIBRI)</b> , Pincés à iris	87, 88	Ciseaux à iridectomie	106, 107
<b>BARRAQUER-KATZIN</b> , Ciseaux corneales	111	Ciseaux à ligatures	106
<b>BARRAQUER-KRATZ</b> , Blépharostats	166	Ciseaux à strabisme	103
<b>BARRAQUER-PHAKO</b> , Blépharostats	166	Ciseaux à ténotomie	104, 109
<b>BARRAQUER-TROUTMAN</b> , Micro-porte-aiguilles à manches rondes	129	Ciseaux corneales	87-90
<b>BECHERT</b> , Crochets pour tourner	158	Ciseaux fins	101
<b>BECHERT-JAFFE</b> , Crochets pour tourner	158	Ciseaux Micro	112-118
<b>BEER</b> , Pincés à épiler les cils	83	Ciseaux oculaires	101-105
<b>BELL</b> , Erisiphaque capsulaire	202	Ciseaux pour capsulotomie	109
<b>BERENS</b> , Pincés musculaires	95	Ciseaux-burins	151
<b>BERKE</b> , Pincés à chalazion	96	Ciseaux-burins à corps étrangers	176-178
Bi-Coagulation, Pincés	209	<b>CITELLI</b> , Pince ostéotome	154
<b>BINKHORST</b> , Pincés capsulaires	89	Clamps Bulldog	77
<b>BISHOP-HARMON</b> , Canules à chambre antérieure	198	<b>CLAYMAN</b> , Crochets pour tourner	158
<b>BISHOP-HARMON</b> , Pincés à iris	87	<b>COLIBRI-BARRAQUER</b> , Blépharostats	166
<b>BLASCOVICS</b> , Pincés musculaires	94	<b>COLLIN</b> , Manches pour bistouris	121
Blépharostats	166-169	Compas	143
<b>BÖHLER</b> , Pince-gouges	151	<b>COOK</b> , Blépharostats	168
<b>BONACCOLTO</b> , Pincés pour sutures	92	<b>CORCELLE</b> , Blépharostats	166
<b>BONN</b> , Anneaux de fixation	194	Couteaux à cataracte	174
<b>BONN</b> , Canules irrigatrice	198	Couteaux à discision	173
<b>BONN</b> , Ciseaux fins	101	Couteaux à goniotomie	174
<b>BONN</b> , Couteaux pour la sclère	174	Couteaux de diamant	180-181
<b>BONN</b> , Crochets à iris	156	Couteaux lenceolaires	175
<b>BONN</b> , Pincés à iris	86, 87	Couteaux pour kératoplastie	175
<b>BORES</b> , Marqueurs axiales	190	Couteaux pour la sclère	174
<b>BOWMAN</b> , Blépharostats	166	Crochets à iris	156, 157
<b>BOWMAN</b> , Sondes exploratrices pour le canal lacrymal	163	Crochets à phaco	159
<b>BROWN-ADSON</b> , Pincés à griffes	82	Crochets à strabisme	154
		Crochets de décollement de la rétine	154
		Crochets manipulateurs à cristallin	158, 159

	Page		Page
Crochets musculaires	154	<b>GRAEFE</b> , Ciseaux oculaires	103
Crochets pour tenotomie	155	<b>GRAEFE</b> , Couteaux à cataract	174
Crochets pour tourner	158	<b>GRAEFE</b> , Crochets à strabisme	154
Crochets très fins	147-150	<b>GRAEFE</b> , Crochets très fins	154
Cuillers à cataracte	185, 186	<b>GRAEFE</b> , Cuillers à cataracte	186
Cuillers à chalazion	185, 186	<b>GRAEFE</b> , Cystotomes	175
Cuillers à énucléation	184	<b>GRAEFE</b> , Pincés à iris	84
Cuillers à éviscération	184	<b>GRAEFE</b> , Pincés à fixer	89
Cuillers pour transférer la cornée	185	<b>GRAETHER</b> , Canules	202
<b>CULLER</b> , Spatules à iris	189	<b>GRANDON</b> , Marqueurs	190
<b>CUSHING</b> , Crochets très fins	149	Grattoirs cornées	173
Cystotomes	175	<b>GREEN</b> , Crochets musculaires	154
D		<b>GREEN</b> , Pincés à fixer	89
<b>DAVIEL</b> , Cuillers à cataracte	186	<b>GUTHRIE</b> , Crochets très fins	155
<b>DAVIS</b> , Ciseaux-Burins à corps étrangers	177	H	
<b>DEITZ</b> , Jauge de profondeur	194	<b>HALLE-HARTMANN</b> , Spéculum naseau	155
Dépresseurs	172	<b>HALSEY</b> , Porte-aiguilles	126
<b>DERF</b> , Porte-aiguilles	126	<b>HALSEY</b> , Porte-aiguilles à mors en carbure de tungstène	126
<b>DERF</b> , Porte-aiguilles à mors en carbure de tungstène	126	<b>HALSTED-MOSQUITO</b> , Pincés hémostatiques	78
<b>DESMARRES</b> , Crochets très fins	155	<b>HAMUBRG</b> , Couteaux lanceolaires	175
<b>DESMARRES</b> , Pincés à chalazion	95	<b>HARMON-BISHOP</b> , Canules à chambre antérieure	198
<b>DIEFFENBACH</b> , Clamps Bulldog	77	<b>HARMON-BISHOP</b> , Pincés à iris	87
<b>DIETHRICH</b> , Micro-porte-aiguilles à mors en carbure de tungstène	128	<b>HARMS</b> , Pincés à ligature avec plate-forme	93
Dilatateurs pour le canal lacrymal	164, 165	<b>HARMS</b> , Sondes trabéculaires	165
<b>DISSECTION</b> , Micro Ciseaux	114, 116	<b>HARTMANN</b> , Pincés hémostatiques	78
<b>DIX</b> , Instrument à corps étrangers	178	<b>HARTMANN-HALLE</b> , Spéculum naseau	155
<b>DORTMUND</b> , Spatules à phaco	187	<b>HEBRA</b> , Cuillers à chalazion	186
<b>DOUGLAS</b> , Pincés à épiler les cils	83	<b>HESS</b> , Pincés à iris	86
<b>DRYSDALE</b> , Crochets manipulateurs à cristallin	159	<b>HESS-GILL</b> , Pincés à iris	88
E		<b>HIRSCHMANN</b> , Crochets à iris	157
Ecarteurs à orbite	171	<b>HIRSCHMANN</b> , IOL Spatules pour manipuler	187
Ecarteurs à sac lacrymal	170	<b>HOFFER</b> , Marqueurs pour centre optique	190
<b>ELLIOT</b> , Manches de Trépan	196	<b>HOPKINS-JOHNS</b> , Clamps Bulldog	77
<b>ELLIOT</b> , Trépans kéroplastie	196	<b>HOPKINS-JOHNS</b> , Pincés à poser	77
<b>ELLIS</b> , Ciseaux-Burins à corps étrangers	177	I	
<b>ELSCHNIG</b> , Pincés à fixer	90	Instruments pour mesurer	143
<b>ERHARDT</b> , Pincés à entropion	95	Instruments pour vitrectomie	182, 183
Erisiphaque capsulaire	202	J	
Extracteur de cortex	200	<b>JACOBSON</b> , Micro-porte-aiguilles	131
Extractor irrigatrices et pour aspiration	199	<b>JACOBSON</b> , Micro-porte-aiguilles à mors en carbure de tungstène	128
F		<b>JAEGER</b> , Plaque à paupières	170
<b>FAULKNER</b> , Pincés à tenir de cristallin	97	<b>JAFFE</b> , Ecarteurs à sac lacrymal	170
<b>FINO-BARRAQUER</b> , Spatules pour cyclodialyse	188	<b>JAFFE</b> , Spatules pour manipuler	187
<b>FISCHER-ARLT</b> , Pincés à iris	85	<b>JAFFE-BECHERT</b> , Crochets pour tourner	158
<b>FLIERINGA</b> , Anneaux de fixation	195	<b>JAFFE-KNOLLE</b> , Crochets à iris	156
<b>FOERSTER</b> , Pincés à iris	86	<b>JAFFE-MALTZMANN</b> , Crochets manipulateurs à cristallin	161
Fraises pour enlever la rouille	195	<b>JAMESON</b> , Crochets musculaires	154
<b>FRANCESCHETTI</b> , Trépans kéroplastie	195	<b>JAMESON</b> , Pied à coulisse	143
<b>FRANCIS</b> , Ciseaux-Burins à corps étrangers	177	<b>JAMESON</b> , Pincés musculaires	94
<b>FRAZIER</b> , Crochets très fins	147	<b>JAPAN-TOHOKU</b> , Pincés à champs	80
stène	126	Jauge de profondeur	194
<b>FRIEDBURG</b> , Canules irrigatrices et pour aspiration	199	<b>JENSEN</b> , Canules gratteuses	202
<b>FRIEDMAN</b> , Pince-gouges	151	<b>JOHNS-HOPKINS</b> , Clamps Bulldog	77
<b>FUCHS-GILL</b> , Pincés à iris	88	<b>JOHNS-HOPKINS</b> , Pincés à poser	77
G		<b>JONES</b> , Pincés à compresses	79
<b>GASS</b> , Crochets de décollement de la rétine	154	K	
<b>GASS</b> , Marqueur scléral	172	<b>KALT</b> , Micro-porte-aiguilles	132
<b>GILL</b> , Kératomes	173	<b>KALT</b> , Micro-porte-aiguilles à mors en carbure de tungstène	128
<b>GILL</b> , Pincés à iris	88	<b>KALT-ARRUGA</b> , Micro-porte-aiguilles	132
<b>GILL-FUCHS</b> , Pincés à iris	88	<b>KALT-CASTROVIEJO</b> , Micro-porte-aiguilles	132
<b>GILL-HESS</b> , Pincés à iris	88	<b>KATZIN</b> , Ciseaux corneales	110
<b>GILLIES</b> , Crochets très fins	147	<b>KATZIN-BARRAQUER (COLIBRI)</b> , Pincés à iris	87, 88
<b>GILLS-WELSH</b> , Ciseaux pour capsulotomie	109	<b>KATZIN-BARRAQUER</b> , Ciseaux corneales	111
<b>GILLS-WELSH</b> , Extracteur de cortex	200	<b>KELMAN</b> , Canules cystotomes	203
<b>GOLF-CLUB</b> , Ciseaux-Burins à corps étrangers	177	<b>KELMAN</b> , Canules pour cyclodialyse	203
<b>GONNIN</b> , Marqueurs	192	<b>KELMAN-McPHERSON</b> , Pincés pour sutures	92
Gouges	155	Kératomes	173
Gouges à corps étrangers	176-178	Kératomètres	193
<b>GRADLE</b> , Pincés à épiler les cils	83	<b>KERRISON</b> , Pince pour sinus sphénoïdal	155

	Page		Page
<b>KILNER</b> , Crochets très fins	147	<b>MOD. HAMBURG</b> , Couteaux lanceolaires	175
<b>KIRBY</b> , Pincés à iris	87	<b>MOD. TÜBINGEN</b> , Pincés pour sutures	92
<b>KLEINERT-KUTZ</b> , Crochets très fins	147	<b>MOD. BONN</b> , Ciseaux fins	101
<b>KNAPP</b> , Crochets très fins	155	N, Pincés pour sutures	92
<b>KNAPP</b> , Cuillers à transférer la cornée	185	<b>MOD. TÜBINGEN-VANNAS</b> , Pincés ciseaux pour le cataracte secondaire	108
<b>KNOLLE</b> , Canules gratteuses	202	<b>MOLDESTAD</b> , Crochets très fins	149
<b>KNOLLE</b> , Crochets à iris	156	<b>MOORFIELD</b> , Pincés pour suture	90
<b>KNOLLE</b> , Spatules pour cyclodialyse	187	<b>MOSQUITO-HALSTED</b> , Pincés hémostatiques	78
<b>KNOLLE-JAFFE</b> , Crochets à iris	156	<b>MULDOON</b> , Dilatateurs pour le canal lacrymal	164
<b>KNOLLE-PEARCE</b> , Anses à cristallin avec irrigation	201	N	
<b>KRATZ</b> , Canules cystotomes	203	<b>NAGAHARA</b> , Lames à phaco	159
<b>KRATZ</b> , Canules gratteuses	202	<b>NERVE</b> , Micro Ciseaux	116
<b>KRATZ-BARRAQUER</b> , Blépharostats	166	<b>NEW ORLEANS</b> , Anses à cataracte	186
<b>KUHNT</b> , Grattoirs cornées	173	<b>NOYES</b> , Ciseaux à iridectomie	106
<b>KUTZ-KLEINERT</b> , Crochets très fins	147	<b>NOYES</b> , Micro Ciseaux	112
L		O	
<b>LA GRANGE</b> , Ciseaux oculaires	104	<b>OB</b> , Aiguilles ophtalmiques	204
Lames de bistouris	122, 123	<b>OBSTBAUM</b> , Spatules pour manipuler	187
Lames de rasoir	124	O'CONNOR, Crochets très fins	154
<b>LAMPERT</b> , Pincés à chalazion	96	<b>OG</b> , Aiguilles ophtalmiques	204
<b>LANCASTER</b> , Blépharostats	168	Ophtalmoscope	144
<b>LASIK</b> , Manipulateur pour reposition du volet	171	<b>OSHER</b> , Crochets manipulateurs à cristallin	158
<b>LESTER</b> , Crochets manipulateurs à cristallin	161	P	
<b>LESTER</b> , Pincés à fixer	90	<b>PARK-MAUMENEE</b> , Blépharostats	167
<b>LESTER-BURCH</b> , Blépharostats	168	<b>PARTSCH</b> , Ciseau-burins	151
<b>LEWICKY</b> , Crochets manipulateurs à cristallin	160	<b>PARTSCH</b> , Marteau	151
<b>LEWIS</b> , Anses à cataracte	186	<b>PATON</b> , Micro-porte-aiguilles	132
<b>LIEBERMAN</b> , Blépharostats	169	<b>PAUFIQUE</b> , Couteaux pour kératoplastie	175
<b>LINDSTROM</b> , Marqueurs pour kéroplastie	191	<b>PAUFIQUE</b> , Pincés pour sutures	93
<b>LIPPMAN</b> , Spatules pour cyclodialyse	187	<b>PEARCE-KNOLLE</b> , Anses à cristallin avec irrigation	201
<b>LITTAUER</b> , Pincés à épiler les cils	83	<b>PEERS</b> , Pincés à champs	80
<b>LORNA</b> , Pincés à compresses	80	<b>PHAKO-BARRAQUER</b> , Blépharostats	166
<b>LU</b> , Marqueurs pour kéroplastie Lasik	191	Pinceau	205
<b>LUER</b> , Pince-gouges	151	Pincés à chalazion	95, 96
M		Pincés à champs	79, 80
<b>MALONEY</b> , Kératomètres	193	Pincés à compresses	79, 80
<b>MALTMANN-JAFFE</b> , Crochets manipulateurs à cristallin	161	Pincés à dissection	82
Manches pour bistouris	121, 122	Pincés à entropion	95
Marqueurs	190-192	Pincés à épiler les cils	83
Marqueurs à sutures	192	Pincés à fixer	89, 90
Marqueurs axiales	190	Pincés à griffes	82
Marqueurs cornées	191	Pincés à iris	84-88
Marqueurs pour centre optique	190	Pincés à ligature avec plate-forme	93
Marqueurs pour incision limbique	192	Pincés à poser	77
Marqueurs pour kéroplastie	192	Pincés à tenir de cristallins	97
Marqueurs radiales	190	Pincés capsulaires	88, 89
Marteau	151	Pincés capsulorhexis	97
<b>MARTIN</b> , Trépans kéroplastie	195	Pincés ciseaux pour le cataracte secondaire	108, 109
<b>MAUMENEE-PARK</b> , Blépharostats	167	Pincés hémostatiques	78
McDONALD, Pincés capsulorhexis	97	Pincés musculaires	94, 95
McINTYRE, Canules à chambre antérieure	199	Pincés ostéotomes	154
McINTYRE, Canules irrigatrice	198	Pincés pour Bi-Coagulation	209
McPHERSON, Pincés à ligature avec plate-forme	91	Pincés pour la chambre antérieure	91
McPHERSON-KELMAN, Pincés pour sutures	92	Pincés pour sinus sphénoïdal	155
<b>MENDEZ</b> , Instruments pour mesurer degré	194	Pincés pour sutures	90-93
<b>MEYHOEFER</b> , Cuillers à chalazion	185	Pincés-gouges	151
Micro Ciseaux	112-118	Pincettes pour casser les lames	124
Micro Ciseaux, Adventitia	114, 116	Pique de fixation	155
Micro Ciseaux, Dissection	114, 116	Plaqué à paupières	170
Micro Ciseaux, Nerve	116	<b>PLEY</b> , Blépharostats	168
<b>MICRO-ADSON</b> , Pincés à dissection	82	Porte-aiguilles à mors en carbure de tungstène	127, 128
<b>MICRO-ADSON</b> , Pincés à griffes	82	<b>POTTS-SMITH</b> , Micro-porte-aiguilles	132
Micro-porte-aiguilles	128-133	<b>POTTS-SMITH</b> , Micro-porte-aiguilles à mors en carbure de tungstène	128
Micro-porte-aiguilles à manches rondes	128, 129, 130, 133	<b>PRINCE</b> , Pincés musculaires	94
Micro-porte-aiguilles à mors en carbure de tungstène	127, 128	Protecteur	171
Micro-porte-aiguilles à mors en carbure de tungstène	127, 128	R	
<b>MOD. BONN</b> , Canules irrigatrice	198	Rabot à callosité manche	196
<b>MOD. BONN</b> , Pincés à iris	86, 87		
<b>MOD. DORTMUND</b> , Spatules à phaco	187		

	Page		Page
<b>REILL</b> , Micro-porte-aiguilles à manches rondes	130	<b>VANNAS MOD. TÜBINGEN</b> , Pincés ciseaux pour le cataracte secondaire	108
<b>RENTSCH</b> , Crochets manipulateurs à cristallin	161	<b>VANNAS</b> , Pincés ciseaux pour le cataracte secondaire	108
<b>RIBBON</b> , Ciseaux oculaires	105		
<b>ROEDER</b> , Pincés à compresses	79	W	
<b>ROLLET</b> , Crochets très fins	155	<b>WECKER</b> , Ciseaux à iridectomie	106
<b>ROSEN</b> , Crochets à phaco	159	<b>WECKER</b> , Spatules à iris	189
<b>RUEDEMANN</b> , Dilatateurs pour le canal lacrymal	164	<b>WELLS</b> , Cuillers à énucléation	184
<b>RYDER/FRENCH-EYE</b> , Porte-aiguilles à mors en carbure de tungstène	126	<b>WELSH</b> , Extracteur de cortex	200
S		<b>WELSH-GILLS</b> , Ciseaux pour capsulotomie	109
<b>SATO</b> , Kératomes	173	<b>WELSH-GILLS</b> , Extracteur de cortex	200
<b>SATTLER</b> , Pincés musculaires	94	<b>WEST</b> , Gouge	155
<b>SAUER</b> , Blépharostats	168	<b>WESTCOTT</b> , Ciseaux à ténatomie	109
<b>SAUTTER</b> , Canules à injection d'air	199	<b>WESTCOTT</b> , Micro Ciseaux	112
<b>SAUTTER</b> , Spatules à orbite	171	<b>WHEELER</b> , Couteaux à discision	173
<b>SCHAEDEL</b> , Pincés à compresses	79	<b>WILDER</b> , Dilatateurs pour le canal lacrymal	164
<b>SCHEPENS</b> , Dépresseurs	172	<b>WILLIAMS</b> , Blépharostats	166
<b>SCHEPENS</b> , Ecarteurs à orbite	171	<b>WILMER</b> , Ciseaux oculaires	103
<b>SCHIOETZ</b> , Tonomètres	193	<b>WORST</b> , Sondes spiralée	165
<b>SCHOCKET</b> , Dépresseurs	172	Z	
<b>SCHOTT</b> , Blépharostats	167	<b>ZIEGLER</b> , Couteaux à discision	173
Sets	55-64	<b>ZIEGLER</b> , Pincés à épiler les cils	83
<b>SIMCOE</b> , Canules irrigatrices et pour aspiration	199		
<b>SIMCOE</b> , Canules manipulation du noyau	201		
<b>SIMCOE</b> , Extracteur de cortex	200		
<b>SINSKEY</b> , Crochets manipulateurs à cristallin	160		
<b>SMITH-POTTS</b> , Micro-porte-aiguilles	132		
<b>SMITH-POTTS</b> , Micro-porte-aiguilles à mors en carbure de tungstène	128		
<b>SNELLEN</b> , Anses à cataracte	186		
<b>SNELLEN</b> , Pincés à entropion	95		
Sondes exploratrices pour le canal lacrymal	163		
Sondes spiralée	165		
Sondes trabéculaires	165		
Spatules à iris	189		
Spatules à orbite	171		
Spatules pour cyclodialyse	188		
Spatules pour manipuler	187		
Spatules pour noyau	187		
Spéculums naseaux	155		
<b>SPENCER</b> , Ciseaux à ligatures	106		
<b>ST. MARTIN</b> , Pincés pour sutures	91		
<b>STEVENS</b> , Ciseaux à ténatomie	104		
<b>STEVENS</b> , Crochets pour tenotomie	155		
<b>STEVENS</b> , Micro-porte-aiguilles	132		
<b>STEVENS</b> , Pincés à iris	85		
<b>STEVENSON</b> , Ecarteurs à sac lacrymal	170		
<b>STILLE</b> , Instrument à corps étrangers	178		
<b>STORZ</b> , Rabot à callosité manche	196		
T			
<b>TERSON</b> , Pincés capsulaires	88		
<b>THORNTON</b> , Anneaux de fixation	194		
<b>THORNTON</b> , Marqueurs pour incision limbique	192		
<b>THORNTON</b> , Marqueurs pour kéroplastie	192		
<b>TOHOKU-JAPAN</b> , Pincés à champs	80		
Tonomètres	193		
<b>TOOK</b> , Kératomes	173		
Trépans kéroplastie	195, 196		
<b>TROUTMAN (CORNEAL)</b> , Pincés à iris	88		
<b>TROUTMAN</b> , Canules à injection Alpha-Chimo-Trypsine	203		
<b>TROUTMAN</b> , Ciseaux corneales	110		
<b>TROUTMAN</b> , Micro-porte-aiguilles à manches rondes	130		
<b>TROUTMAN-BARRAQUER</b> , Micro-porte-aiguilles à manches rondes	129		
<b>TROUTMAN-CHRIS</b> , Pincettes pour casser les lames	124		
<b>TÜBINGEN MOD. VANNAS</b> , Pincés ciseaux pour cataracte secondaire	108		
<b>TÜBINGEN</b> , Pincés pour sutures	92		
<b>TYRELL</b> , Crochets à iris	157		
V			

# Indice alfabetico

	Pagina		Pagina
<b>A</b>			
<b>ADSON, MICRO</b> Pinze anatomiche per dissezione	82	<b>BROWN-ADSON</b> , Pinze chirurgiche a denti di topo	82
<b>ADSON, MICRO</b> Pinze chirurgiche a denti di topo	82	<b>BUNGE</b> , Cucchiai da enucleazione	184
<b>ADSON</b> , Pinze anatomiche per dissezione	82	<b>BUNNKATU</b> , Uncinetti per posizionare cristallino	159
<b>ADSON</b> , Pinze chirurgiche a denti di topo	82	<b>BURCH</b> , Uncinetti per fissazione	155
<b>ADSON-BROWN</b> , Pinze chirurgiche a denti di topo	82	<b>BURCH-LESTER</b> , Blefarostati	168
<b>ADVENTITIA</b> , Micro forbici	114-116	<b>C</b>	
Aghi oftalmichi	204	Calamita per occhi con ansa per corpi estranei	178
Aghi per corpi estranei	176-178	Cannula per lavaggio	201
<b>AGRICOLA</b> , Divaricatori per sacco lacrimale	170	Cannule per iniettare area	199
<b>ANEL</b> , Cannule per vie lacrimali	200	Cannule d'irrigazione	198
Anelli di fissazione	194, 195	Cannule d'irrigazione e d'aspirazione	199
<b>ANIS</b> , Marcatori per sutura	192	Cannule d'irrigazione per camera anteriore	198
<b>ANIS</b> , Marcatori radiali	190	Cannule per alfa-chimotripsina	203
Anse per cataratta	186	Cannule per camera anteriore	199
Anse per cristallino	185	Cannule per ciclodialisi	203
Anse per cristallino con irrigazione	201	Cannule per cistotomi	203
<b>ARLT</b> , Anse per cataratta	186	Cannule per vie lacrimali	200
<b>ARLT-FISCHER</b> , Pinze per iride	85	<b>CASTROVIEJO</b> , Blefarostati	167
<b>ARRUGA</b> , Micro-portaghi	132	<b>CASTROVIEJO</b> , Compasso	143
<b>ARRUGA</b> , Pinze capsulari	89	cchiai corneali	185
<b>ARRUGA</b> , Protettore	171	<b>CASTROVIEJO</b> , Dilatatori per canale lacrimale	165
<b>ARRUGA-KALT</b> , Micro-portaghi	132	<b>CASTROVIEJO</b> , Forbici per cornea	109, 110
Aspiratore capsulare	202	<b>CASTROVIEJO</b> , Forbici per iridectomia	107
<b>AYER</b> , Pinze per calazio	95	<b>CASTROVIEJO</b> , Micro-portaghi	131
<b>B</b>			
<b>BACKHAUS</b> , Pinze per fissare le compresse	79	<b>CASTROVIEJO</b> , Micro-portaghi con manici rotondi	133
<b>BARKAN</b> , Coltelli per goniotomia	174	<b>CASTROVIEJO</b> , Micro-portaghi, carburo di tungsteno	127, 128
<b>BARRAQUER PHAKO</b> , Blefarostati	166	<b>CASTROVIEJO</b> , Pinze capsulari	88
<b>BARRAQUER</b> , Blefarostati	166	<b>CASTROVIEJO</b> , Pinze fissatrici	90
<b>BARRAQUER</b> , Forbici per iridectomia	107	<b>CASTROVIEJO</b> , Pinze per sutura	91
<b>BARRAQUER</b> , Micro-portaghi con manici rotondi	129	<b>CASTROVIEJO</b> , Spatole per ciclodialisi	188
<b>BARRAQUER</b> , Pinze depilatorie	83	<b>CASTROVIEJO</b> , Trepani corneali	195
<b>BARRAQUER</b> , Pinze per la camera anteriore	91	<b>CASTROVIEJO-BARRAQUER</b> , Spatole per ciclodialisi	188
<b>BARRAQUER-CASTROVIEJO</b> , Spatole per ciclodialisi	188	<b>CASTROVIEJO-KALT</b> , Mico-portaghi	132
<b>BARRAQUER-COLIBRI</b> , Blefarostati	166	Cavi da connessione	209
<b>BARRAQUER-FINO</b> , Spatole per ciclodialisi	188	<b>CHADWICK</b> , Forbici oftalmologici	104
<b>BARRAQUER-KATZIN (COLIBRI)</b> , Pinze per iride	87, 88	Cheratometro	193
<b>BARRAQUER-KATZIN</b> , Forbici per cornea	111	<b>CHRIS-TROUTMAN</b> , Pinze per rompere la lamette	124
<b>BARRAQUER-KRATZ</b> , Blefarostati	166	Cistotomi	175
<b>BARRAQUER-TROUTMAN</b> , Micro-portaghi con manici rotondi	129	<b>CITELLI</b> , Pinze osteotomi	154
<b>BECHERT</b> , Uncinetti per rotazione di nucleo cristallino	158	<b>CLAYMAN</b> , Uncinetti per rotazione di nucleo cristallino	158
<b>BECHERT-JAFFE</b> , Uncinetti per rotazione di nucleo cristallino	158	<b>COLIBRI-BARRAQUER</b> , Blefarostati	166
<b>BEER</b> , Pinze depilatorie	83	<b>COLLIN</b> , Manici per bisturi	121
<b>BELL</b> , Aspiratore capsulare	202	Coltelli di diamanti	180-181
Benda di protezione per gli occhi	205	Coltelli lanceolari	175
<b>BERENS</b> , Pinze muscolari	95	Coltelli per cheratoplastica	175
<b>BERKE</b> , Pinze per calazio	96	Coltelli per cornea	173
<b>BINKHORST</b> , Pinze capsulari	89	Coltelli per cataratta	174
<b>BISHOP-HARMON</b> , Cannule d'irrigazione per camera anteriore	198	Coltelli per discissione	173
<b>BISHOP-HARMON</b> , Pinze per iride	87	Coltelli per goniotomia	174
<b>BLASCOVICS</b> , Pinze muscolari	94	Coltelli sclerali	174
Blefarostati	166-169	Compassi	143
<b>BÖHLER</b> , Pinze-sgorbie	151	Contentore e accessori	46
<b>BONACCOLTO</b> , Pinze per sutura	92	<b>COOK</b> , Blefarostati	168
<b>BONN</b> , Anelli di fissazione	194	<b>CORCELLE</b> , Blefarostati	166
<b>BONN</b> , Cannule d'irrigazione	198	Cucchiai per calazio	185, 186
<b>BONN</b> , Coltelli sclerali	174	Cucchiai per cataratta	185, 186
<b>BONN</b> , Forbici fini	101	Cucchiai per enucleazione	184
<b>BONN</b> , Pinze per iride	86, 87	<b>CULLER</b> , Spatole per l'iride	189
<b>BONN</b> , Pinze per sutura	92	<b>CUSHING</b> , Divaricatori sottili	149
<b>BONN</b> , Uncinetti per l'iride	156	<b>D</b>	
<b>BORES</b> , Marcatori assiali	190	<b>DAVIEL</b> , Cucchiai per cataratta	186
<b>BOWMAN</b> , Blefarostati	166	<b>DAVIS</b> , Scalpelli per corpi estranei	177
<b>BOWMAN</b> , Sonde esploratrici per canale lacrimale	163	<b>DEITZ</b> , Misuratori di profondità	194
		Depressore	172
		<b>DERF</b> , Portaghi	126

<b>DERF</b> , Portaghi con placche di carburo di tungsteno	126	<b>GUTHRIE</b> , Divaricatori sottili	155
<b>DESMARRES</b> , Divaricatori sottili	155	H	
<b>DESMARRES</b> , Pinze per calazio	95	<b>HALLE-HARTMANN</b> , Specoli nasali	155
<b>DIEFFENBACH</b> , Pinze Bulldog	77	<b>HALSEY</b> , Portaghi	126
<b>DIETHRICH</b> , Micro-portaghi con placche di carburo di tungsteno	128	<b>HALSEY</b> , Portaghi con placche di carburo di tungsteno	126
Dilatatori per canale lacrimale	164, 165	<b>HALSTED-MOSQUITO</b> , Pinze emostatiche	78
<b>DISSECTION</b> , Micro forbici	114, 116	<b>HAMBURG</b> , Coltelli lanceolari	175
Divaricatori orbitale	171	<b>HARMON-BISHOP</b> , Cannule d'irrigazione per camera anteriore	198
Divaricatori per sacco lacrimale	170	<b>HARMON-BISHOP</b> , Pinze per iride	87
Divaricatori sottili	147-150	<b>HARMS</b> , Pinze per legature con piattaforma	93
<b>DIX</b> , Strumenti per corpi estranei	178	<b>HARMS</b> , Sonde trabecolari	165
<b>DORTMUND</b> , Spatole per fako	187	<b>HARTMANN</b> , Pinze emostatiche	78
<b>DOUGLAS</b> , Pinze depilatorie	83	<b>HARTMANN-HALLE</b> , Specoli nasali	155
<b>DRYSDALE</b> , Uncinetti per posizionare cristallino	159	<b>HEBRA</b> , Cucchiari per calazio	186
E		<b>HESS</b> , Pinze per iride	86
Elevatori per palpebre	170	<b>HESS-GILL</b> , Pinze capsulari	88
<b>ELLIOT</b> , Trepani corneali	196	<b>HIRSCHMANN</b> , IOL Spatole per manipolare	187
<b>ELLIS</b> , Scalpelli per corpi estranei	177	<b>HIRSCHMANN</b> , Uncinetti per l'iride	157
<b>ELSCHNIG</b> , Pinze fissatrici	90	<b>HOFFER</b> , Marcatori ottici	190
<b>ERHARDT</b> , Pinze per palpebre (entropio)	95	<b>HOPKINS-JOHNS</b> , Pinze Bulldog	77
Estrattore per capsula	200	<b>HOPKINS-JOHNS</b> , Pinze per posizionare	77
F		I	
<b>FAULKNER</b> , Pinze per tenere il cristallino	97	Irrigatore per lenti intraoculari	201
<b>FINO-BARRAQUER</b> , Spatole per ciclodialisi	188	J	
<b>FISCHER-ARLT</b> , Pinze per iride	85	<b>JACOBSON</b> , Micro-portaghi	131
<b>FLIERINGA</b> , Anelli di fissazione	197	<b>JACOBSON</b> , Micro-portaghi con placche di carburo di tungsteno	128
<b>FOERSTER</b> , Pinze per iride	86	<b>JAEGER</b> , Elevatori per palpebre	170
Forbici fini	101	<b>JAFFE</b> , Blefarostati	170
Forbici oftalmologici	101-105	<b>JAFFE</b> , Spatole per manipolare	187
Forbici per cornea	87-90	<b>JAFFE-BECHERT</b> , Uncinetti per rotazione di nucleo cristallino	158
Forbici per iridectomia	102, 106, 107	<b>JAFFE-KNOLLE</b> , Uncinetti per l'iride	156
Forbici per legatura	106	<b>JAFFE-MALTZMANN</b> , Uncini per posizionare cristallino	161
Forbici per strabismo	103	<b>JAMESON</b> , Calibro micrometrico	143
Forbici per tenotomia	104, 109	<b>JAMESON</b> , Pinze muscolari	94
Forbici per vitrectomia	182	<b>JAMESON</b> , Uncinetti per muscoli	154
<b>FRANCESCHETTI</b> , Trepani corneali	195	<b>JAPAN-TOHOKU</b> , Pinze per fissare le compresse	80
<b>FRANCIS</b> , Scalpelli per corpi estranei	177	<b>JENSEN</b> , Levigatore corneale	202
<b>FRAZIER</b> , Divaricatori sottili	147	<b>JOHNS-HOPKINS</b> , Pinze bulldog	77
<b>FRENCH-EYE/Ryder</b> , Portaghi con placche di carburo di tungsteno	126	<b>JOHNS-HOPKINS</b> , Pinze per posizionare	77
Fresa corneale	197	<b>JONES</b> , Pinze per fissare le compresse	79
<b>FRIEDBURG</b> , Cannule d'irrigazione e d'aspirazione	199	K	
<b>FRIEDMAN</b> , Pinze-sgorbie	151	<b>KALT</b> , Micro-portaghi	132
<b>FUCHS-GILL</b> , Pinze capsulari	88	<b>KALT</b> , Micro-portaghi con placche di carburo di tungsteno	128
G		<b>KALT-ARRUGA</b> , Micro-portaghi	132
<b>GASS</b> , Marcadori sclerali	172	<b>KALT-CASTROVIEJO</b> , Mico-portaghi	132
<b>GASS</b> , Uncinetti corneali	154	<b>KATZIN</b> , Forbici per cornea	110
<b>GILL</b> , Coltelli per cornea	173	<b>KATZIN-BARRAQUER (COLIBRI)</b> , Pinze per iride	87, 88
<b>GILL</b> , Pinze capsulari	88	<b>KATZIN-BARRAQUER</b> , Forbici per cornea	111
<b>GILL-FUCHS</b> , Pinze capsulari	88	<b>KELMAN</b> , Cannule per ciclodialisi	203
<b>GILL-HESS</b> , Pinze capsulari	88	<b>KELMAN</b> , Cannule per cistotomi	203
<b>GILLIES</b> , Divaricatori sottili	147	<b>KELMAN-McPHERSON</b> , Pinze per sutura	92
<b>GILLS-WELSH</b> , Estrattore per capsula	200	<b>KERRISON</b> , Pinze per seno sfenoidale	155
<b>GILLS-WELSH</b> , Pinze-forbici per cataratta secondaria	109	<b>KILNER</b> , Divaricatori sottili	147
<b>GOLF-CLUB</b> , Scalpelli per corpi estranei	177	<b>KIRBY</b> , Pinze per iride	87
<b>GONNIN</b> , Marcatori ottici Amsler	192	<b>KLEINERT-KUTZ</b> , Divaricatori sottili	147
<b>GRADLE</b> , Pinze depilatorie	83	<b>KNAPP</b> , Anse per trasferire la cornea	185
<b>GRAEFE</b> , Cistotomi	175	<b>KNAPP</b> , Divaricatori sottili	155
<b>GRAEFE</b> , Coltelli per cataratta	174	<b>KNOLLE</b> , Levigatore corneale	202
<b>GRAEFE</b> , Cucchiari per cataratta	186	<b>KNOLLE</b> , Spatole per nucleo cristallino	187
<b>GRAEFE</b> , Divaricatori sottili	154	<b>KNOLLE</b> , Uncinetti per l'iride	156
<b>GRAEFE</b> , Forbici oftalmologici	103	<b>KNOLLE-JAFFE</b> , Uncinetti per l'iride	156
<b>GRAEFE</b> , Pinze fissatrici	89	<b>KNOLLE-PEARCE</b> , Anse per cristallino con irrigazione	201
<b>GRAEFE</b> , Pinze per iride	84	<b>KRATZ</b> , Cannule per cistotomi	203
<b>GRAEFE</b> , Uncinetti per strabismo	154	<b>KRATZ</b> , Levigatore corneale	202
<b>GRAETHER</b> , Cannule	202	<b>KRATZ-BARRAQUER</b> , Blefarostati	166
<b>GRANDON</b> , Marcatori ottici	190	<b>KUHNT</b> , Raschiatoi corneali	173
<b>GREEN</b> , Pinze fissatrici	89	<b>KUTZ-KLEINERT</b> , Divaricatori sottili	147
<b>GREEN</b> , Uncinetti per muscoli	154	L	
		<b>LA GRANGE</b> , Forbici oftalmologici	104



	Pagina		Pagina
Lame per bisturi	122, 123	O	
Lamette da barba	124	<b>OB</b> , Aghi oftalmichi	204
<b>LAMPERT</b> , Pinze per calazio	96	<b>OBSTBAUM</b> , Spatole per manipolare	187
<b>LANCASTER</b> , Blefarostati	168	<b>O'CONNOR</b> , Divaricatori sottili	154
<b>LASIK</b> , Manipolatore di lamella	171	Oftalmoscopio	144
<b>LESTER</b> , Pinze fissatrici	90	<b>OG</b> , Aghi oftalmichi	204
<b>LESTER</b> , Uncini per posizionare cristallino	161	<b>OSHER</b> , Uncinetti per posizionare cristallino	158
<b>LESTER-BURCH</b> , Blefarostati	168	P	
Levigatore corneale	202	<b>PARK-MAUMENEE</b> , Blefarostati	167
<b>LEWICKY</b> , Uncini per posizionare cristallino	160	<b>PARTSCH</b> , Martelli	151
<b>LEWIS</b> , Anse per cataratta	186	<b>PARTSCH</b> , Scalpelli	151
<b>LIEBERMAN</b> , Blefarostati	169	<b>PATON</b> , Micro-portaghi	132
<b>LINDSTROM</b> , Marcatori corneali	191	<b>PAUFIQUE</b> , Coltelli per cheratoplastica	175
<b>LIPPMAN</b> , Spatole per nucleo cristallino	187	<b>PAUFIQUE</b> , Pinze per sutura	93
<b>LITTAUER</b> , Pinze depilatorie	83	<b>PEARCE-KNOLLE</b> , Anse per cristallino con irrigazione	201
<b>LORNA</b> , Pinze per fissare le compresse	80	<b>PEERS</b> , Pinze per fissare le compresse	80
<b>LU</b> , Marcatori corneali Lasik	191	Pennello	205
<b>LUER</b> , Pinze-sgorbie	151	<b>PHAKO BARRAQUER</b> , Blefarostati	166
M	46	Pinze anatomiche per dissezione	82
<b>MALONEY</b> , Cheratometro	193	Pinze Bulldog	77
<b>MALTZMANN-JAFFE</b> , Uncini per posizionare cristallino	161	Pinze capsulari	88, 89
Manici per bisturi	121, 122	Pinze capsulorhexis	97
Marcadori sclerali	172	Pinze chirurgiche a denti di topo	82
Marcatori	190-192	Pinze depilatorie	83
Marcatori assiali	190	Pinze emostatiche	78
Marcatori corneali	191, 192	Pinze fissatrici	89, 99
Marcatori ottici	190	Pinze muscolari	94, 95
Marcatori per incisione	190	Pinze osteotomi	154
Marcatori per incisione in limbo	192	Pinze per calazio	95, 96
Marcatori per sutura	190, 192	Pinze per fissare le compresse (Fissarele)	79, 80
Marcatori radiali	190	Pinze per iride	84-88
Martelli	151	Pinze per la Bi-Coagulazione	209
<b>MARTIN</b> , Trepani corneali	195	Pinze per la camera anteriore	91
<b>MAUMENEE-PARK</b> , Blefarostati	167	Pinze per ligature con piattaforma	93
McDONALD, Pinze capsulorhexis	97	Pinze per palpebre (entropio)	95
McINTYRE, Cannule d'irrigazione	198	Pinze per posizionare	77
McPHERSON, Pinze per ligature	91	Pinze per rompere la lamette	124
McPHERSON-KELMAN, Pinze per sutura	92	Pinze per seno sfenoidale	155
<b>MENDEZ</b> , Strumenti per misurare	194	Pinze per sutura	90-93
<b>MEYHOEFER</b> , Cucchiari per calazio	185	Pinze per tenere il cristallino	97
Micro Forbici	112-118	Pinze per vitrectomia	183
Micro forbici, Adventitia	114, 116	Pinze-forbici per cataratta secondaria	108, 109
Micro forbici, Dissection	114, 116	Pinze-sgorbie	151
Micro forbici, Nerve	116	<b>PLEY</b> , Blefarostati	168
<b>MICRO-ADSON</b> , Pinze anatomiche per dissezione	82	Portaghi con placche di carburo di tungsteno	126-128
<b>MICRO-ADSON</b> , Pinze chirurgiche a denti di topo	82	<b>POTTS-SMITH</b> , Micro-portaghi	132
Micro-portaghi	128-133	<b>POTTS-SMITH</b> , Micro-portaghi con placche di carburo di tungsteno	128
Micro-portaghi con manici rotondi	128, 129, 130, 133	<b>PRINCE</b> , Pinze muscolari	94
Micro-portaghi con placche di carburo di tungsteno	127, 128	R	
Misuratori di profondità	194	Raschiatoi corneali	173
<b>MOD. BONN</b> , Cannule d'irrigazione	198	<b>REILL</b> , Micro-portaghi con manici rotondi	130
<b>MOD. BONN</b> , Forbici fini	101	<b>RENTSCH</b> , Uncini per posizionare cristallino	161
<b>MOD. BONN</b> , Pinze per sutura	92	<b>ROEDER</b> , Pinze per fissare le compresse	79
<b>MOD. DORTMUND</b> , Spatole per fako	187	<b>ROLLET</b> , Divaricatori sottili	155
<b>MOD. HAMBURG</b> , Coltelli lanceolari	175	<b>ROSEN</b> , Uncini per fako	159
<b>MOD. TÜBINGEN</b> , Pinze per sutura	92	<b>RUEDEMANN</b> , Dilatatori per canale lacrimale	164
<b>MOD. TÜBINGEN-VANNAS</b> , Pinze-forbici per cataratta secondaria	108	<b>RYDER/FRENCH-EYE</b> , Portaghi con placche di carburo di tungsteno	126
<b>MOD. BONN</b> , Pinze per iride	86, 41	S	
<b>MOLDESTAD</b> , Divaricatori sottili	149	<b>SATO</b> , Coltelli per cornea	173
<b>MOORFIELD</b> , Pinze per sutura	90	<b>SATTLER</b> , Pinze muscolari	94
<b>MOSQUITO-HALSTED</b> , Pinze emostatiche	78	<b>SAUER</b> , Blefarostati	168
<b>MULDOON</b> , Dilatatori per canale lacrimale	164	<b>SAUTTER</b> , Cannule per iniettare area	199
N		<b>SAUTTER</b> , Spatole per orbita	171
<b>NAGAHARA</b> , Lame Fako Chopper	159	Scalpelli	151
<b>NERVE</b> , Micro forbici	116	Scalpelli per corpi estranei	176-178
<b>NEW ORLEANS</b> , Anse per cataratta	186	<b>SCHAEDEL</b> , Pinze per fissare le compresse	79
<b>NOYES</b> , Forbici per iridectomia	106	<b>SCHEPENS</b> , Depressore	172
<b>NOYES</b> , Micro forbici	112	<b>SCHEPENS</b> , Divaricatori orbitale	171
		<b>SCHIOETZ</b> , Tonometri	193

<b>SCHOCKET</b> , Depressore	172	<b>WELSH</b> , Estrattore per capsula	200
<b>SCHOTT</b> , Blefarostati	167	<b>WELSH-GILLS</b> , Estrattore per capsula	200
Sets	55-64	<b>WELSH-GILLS</b> , Pinze-forbici per cataratta secondaria	109
Sgorbie	155	<b>WEST</b> , Sgorbie	155
Sgorbie per corpi estranei	176	<b>WESTCOTT</b> , Forbici per tenotomia	109
<b>SIMCOE</b> , Anse per cristallino con irrigazione	201	<b>WESTCOTT</b> , Micro forbici	112
<b>SIMCOE</b> , Cannule d'irrigazione e d'aspirazione	199	<b>WHEELER</b> , Coltelli per discissione	173
<b>SIMCOE</b> , Estrattore per capsula	200	<b>WILDER</b> , Dilatatori per canale lacrimale	164
<b>SINSKEY</b> , Uncini per posizionare cristallino	160	<b>WILLIAMS</b> , Blefarostati	166
Small Set Container	218-220	<b>WILMER</b> , Forbici oftalmologici	103
<b>SMITH-POTTS</b> , Micro-portaghi	132	<b>WORST</b> , Sonde a pigtail	165
<b>SMITH-POTTS</b> , Micro-portaghi con placche di carburo di tungsteno	128	Z	
<b>SNELLEN</b> , Anse per cataratta	186	<b>ZIEGLER</b> , Coltelli per discissione	173
<b>SNELLEN</b> , Pinze per palpebre (entropio)	95	<b>ZIEGLER</b> , Pinze depilatorie	83
Sonde a pigtail	165		
Sonde esploratrici per canale lacrimale	163		
Sonde trabecolari	165		
Spatole per ciclodialisi	188		
Spatole per fako	187		
Spatole per l'iride	189		
Spatole per manipolare	187		
Spatole per nucleo cristallino	187		
Spatole per orbita	171		
Specoli nasali	155		
<b>SPENCER</b> , Forbici per legatura	106		
<b>ST. MARTIN</b> , Pinze per sutura	91		
<b>STEVENS</b> , Forbici per tenotomia	104		
<b>STEVENS</b> , Micro-portaghi	132		
<b>STEVENS</b> , Pinze per iride	85		
<b>STEVENS</b> , Uncinetti de tendini	155		
<b>STEVENSON</b> , Divaricatori per sacco lacrimale	170		
<b>STILLE</b> , Strumenti per corpi estranei	178		
<b>STORZ</b> , Trepani corneali	196		
Strumenti per misurare	143, 194		
Strumenti per misurazione	194		
Strumenti per vitrectomia	182, 183		
T			
<b>TERSON</b> , Pinze capsulari	88		
<b>THORNTON</b> , Anelli di fissazione	194		
<b>THORNTON</b> , Marcatori corneali	192		
<b>THORNTON</b> , Marcatori incisione in limbo	192		
<b>TOHOKU-JAPAN</b> , Pinze per fissare le compresse	80		
Tonometri	193		
<b>TOOK</b> , Coltelli per cornea	173		
Trepani corneali	195, 196		
<b>TROUTMAN (CORNEAL)</b> , Pinze per iride	88		
<b>TROUTMAN</b> , Cannule per Alpha-Chymotrypsin	203		
<b>TROUTMAN</b> , Forbici per cornea	110		
<b>TROUTMAN</b> , Micro-portaghi con manici rotondi	130		
<b>TROUTMAN-BARRAQUER</b> , Micro-portaghi con manici rotondi	129		
<b>TROUTMAN-CHRIS</b> , Pinze per rompere la lamette	124		
<b>TÜBINGEN</b> , Pinze per sutura	92		
<b>TYRELL</b> , Uncinetti per l'iride	157		
U			
Uncinetti de tendini	155		
Uncinetti per fissazione	155		
Uncinetti per l'iride	156, 157		
Uncinetti per muscoli	154		
Uncinetti per posizionare cristallino	158-161		
Uncinetti per rotazione di nucleo cristallino	158		
Uncinetti per strabismo	154		
Uncini per faco	159		
V			
<b>VANNAS MOD. TÜBINGEN</b> , Pinze-forbici per cataratta secondaria	108		
<b>VANNAS</b> , Pinze-forbici per cataratta secondaria	108		
W			
<b>WECKER</b> , Forbici per iridectomia	106		
<b>WECKER</b> , Spatole per l'iride	189		
<b>WELLS</b> , Cucchiari da enucleazione	184		



**nopa**<sup>®</sup> instruments

**nopa instruments**

Medizintechnik GmbH

Weilatten 7-9

D - 78532 Tuttlingen

Tel. +49.7462.9490-0

Fax +49.7462.9490-90

info@nopa.de

www.nopa.de

Herstellung und Verkauf chirurgischer  
und endoskopischer Instrumente.

Manufacture and Sales of Surgical  
and Endoscopic Instruments.

